

Data sheet | Item number: 750-400
2-channel digital input; 24 VDC; 3 ms

www.wago.com/750-400

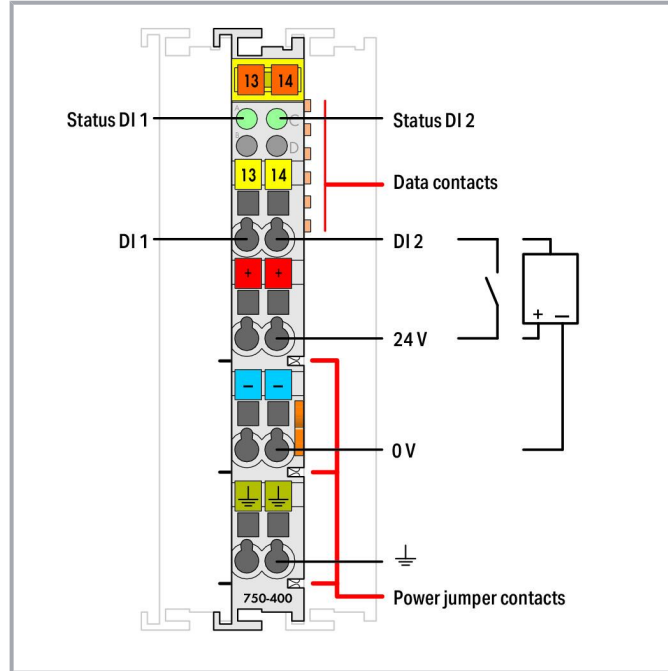
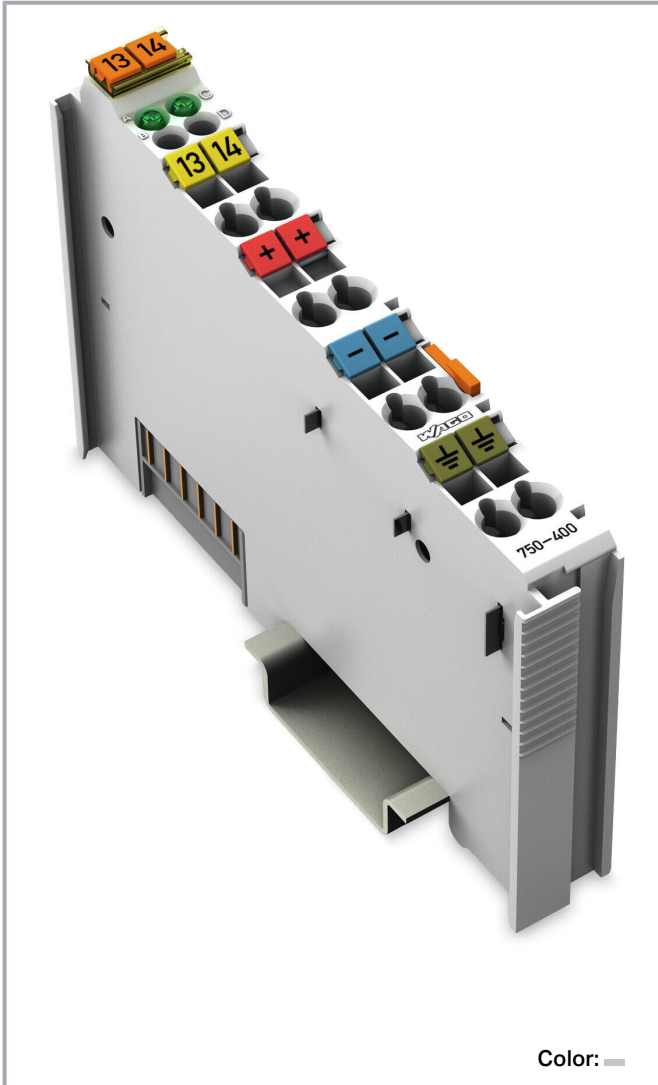

Subject to changes. Please also observe the further product documentation!

WAGO GmbH & Co. KG
Hansastr. 27
32423 Minden
Phone: +49571 887-0 | Fax: +49571 887-169
Email: info.de@wago.com | Web: www.wago.com

Do you have any questions about our products?
We are always happy to take your call at +49 (571) 887-44222.

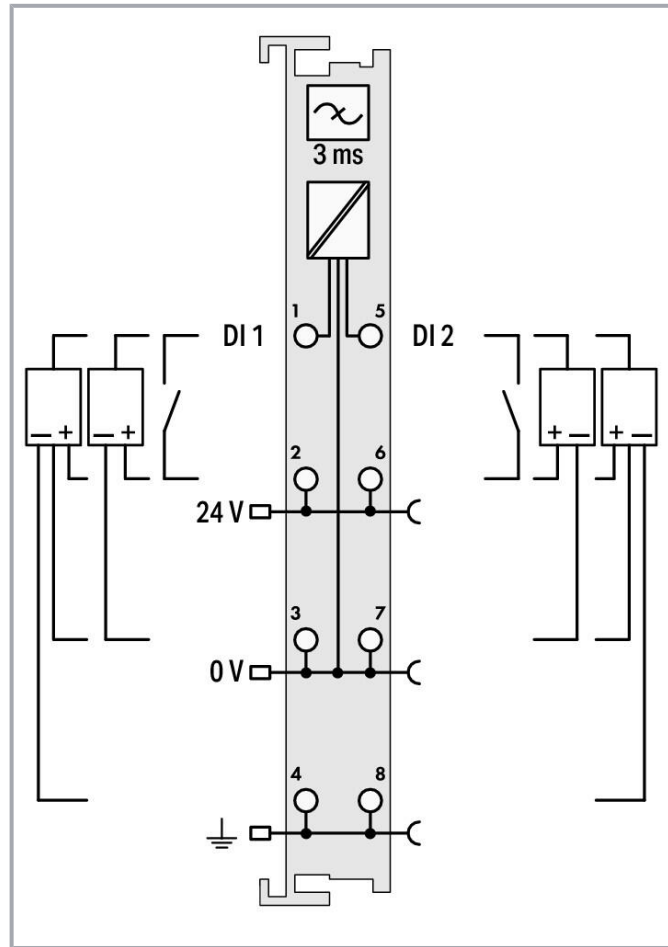
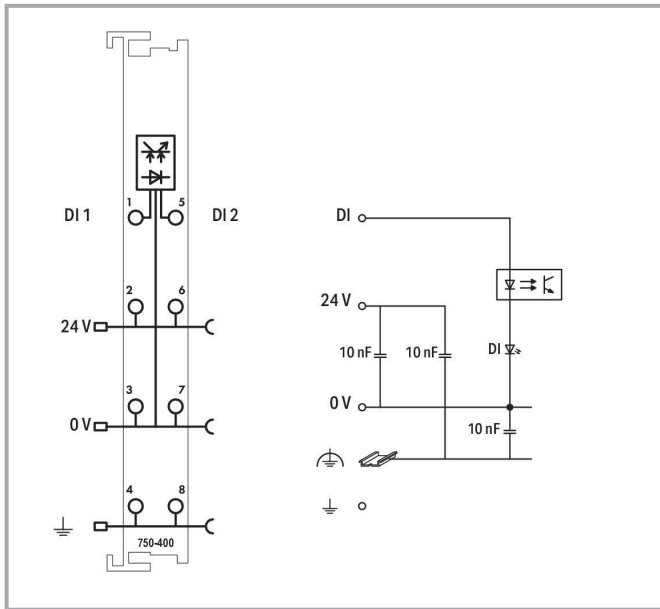

Item description

This digital input module receives control signals from field devices (e.g., sensors).

Each input module has a noise-rejection filter.

Field and system levels are electrically isolated.

Data

Technical data

Number of digital inputs	2
Total number of channels (module)	2
Signal type	Digital Voltage
Signal type (voltage)	24 VDC

Subject to changes. Please also observe the further product documentation!



Supply voltage (sensor)	24 VDC
Sensor connection	2 x (2-wire, 3-wire, 4-wire)
Input characteristic	high-side switching
Input filter (digital)	3 ms 3 ms
Input current per channel for signal (1) typ.	4.5 mA
Voltage range for signal (0)	-3 ... +5 VDC
Voltage range for signal (1)	15 ... 30 VDC
Input data width (internal) max.	2 bits
Supply voltage (system)	5 VDC; via data contacts
Current consumption (5 V system supply)	3.7 mA
Supply voltage (field)	24 VDC (-25 ... +30 %); via power jumper contacts (power supply via blade contact; transmission via spring contact)
Isolation	500 V system/field
Indicators	LED (A, C) green: Status DI 1, DI 2
Number of incoming power jumper contacts	3
Number of outgoing power jumper contacts	3
Current carrying capacity (power jumper contacts)	10 A

Connection data

Connection technology: inputs/outputs	8 x CAGE CLAMP®
Connection type 1	Inputs/Outputs
Solid conductor	0.08 ... 2.5 mm ² / 28 ... 14 AWG
Fine-stranded conductor	0.08 ... 2.5 mm ² / 28 ... 14 AWG
Strip length	8 ... 9 mm / 0.31 ... 0.35 inches

Physical data

Width	12 mm / 0.472 inches
Height	100 mm / 3.937 inches
Depth	69.8 mm / 2.748 inches
Depth from upper-edge of DIN-rail	62.6 mm / 2.465 inches

Mechanical Data

Mounting type	DIN-35 rail
Pluggable connector	Fixed

Subject to changes. Please also observe the further product documentation!



Material Data

Color	light gray
Housing material	Polycarbonate; polyamide 6.6
Fire load	1.209 MJ
Weight	45.8 g
Conformity marking	CE

Environmental requirements

Ambient temperature (operation)	0 ... +55 °C
Ambient temperature (storage)	-25 ... +85 °C
Protection type	IP20
Pollution degree	2 per IEC 61131-2
Operating altitude	0 ... 2000 m / 0 ... 6562 ft
Mounting position	horizontal (standing/lying); vertical
Relative humidity (without condensation)	95 %
Vibration resistance	4g per IEC 60068-2-6
Shock resistance	15g per IEC 60068-2-27
EMC immunity to interference	per EN 61000-6-2, marine applications
EMC emission of interference	per EN 61000-6-4, marine applications
Exposure to pollutants	Per IEC 60068-2-42 and IEC 60068-2-43
Permissible H ₂ S contaminant concentration at a relative humidity 75 %	10 ppm
Permissible SO ₂ contaminant concentration at a relative humidity 75 %	25 ppm

Commercial data

Product Group	15 (I/O System)
eCl@ss 10.0	27-24-26-04
eCl@ss 9.0	27-24-26-04
ETIM 8.0	EC001599
ETIM 7.0	EC001599
PU (SPU)	1 pcs
Packaging type	box
Country of origin	DE
GTIN	4045454424251

Subject to changes. Please also observe the further product documentation!

WAGO GmbH & Co. KG
 Hansastr. 27
 32423 Minden
 Phone: +49571 887-0 | Fax: +49571 887-169
 Email: info.de@wago.com | Web: www.wago.com

Do you have any questions about our products?
 We are always happy to take your call at +49 (571) 887-44222.



Customs tariff number	8538909990
-----------------------	------------

Environmental Product Compliance



CAS-No.	1303-86-2 1317-36-8 7439-92-1
REACH Candidate List Substance	Diboron trioxide Lead Lead monoxide
RoHS Compliance Status	Compliant, With Exemption
RoHS Exemption	6(c) 7(a) 7(c)-I 7(c)-II
SCIP notification number (Austria)	35d1bd2d-1dd4-4949-936a-c10f9d8f4359
SCIP notification number (Belgium)	119e9707-a7b8-49ce-8650-b187b4d1d894
SCIP notification number (Bulgaria)	43a66e7a-333a-450a-b7ce-2a330c2bf26d
SCIP notification number (Czech Republic)	c4ef2ef5-9eb7-4550-bea3-21eaca67a60f
SCIP notification number (Denmark)	107c1150-20b7-42d6-b924-79659ef9c1e1
SCIP notification number (Finland)	253d5b41-1c4f-4ec0-bc02-5e79ab22731f
SCIP notification number (France)	d248b7be-a29a-4f81-8447-81d3c4c63e6b
SCIP notification number (Germany)	e19c8424-ea77-4459-8b1b-e15c8c9fd603
SCIP notification number (Hungary)	a23d906e-873d-454a-9f6b-6dc0baa18933
SCIP notification number (Italy)	b8d2ef7b-9f23-466d-87bd-5d01d0e6d61a
SCIP notification number (Netherlands)	76d1a84c-03ad-4309-b8c3-f12ae7983786
SCIP notification number (Poland)	99a0b07c-fb79-4824-be66-ceb4b1ae89a0
SCIP notification number (Romania)	fcad878d-d438-473d-a716-c9bdcaeb349d
SCIP notification number (Sweden)	f4c35607-1d0c-4bfa-ba35-6d631aab3b0

Approvals / Certificates



General approvals

Logo	Approval	Additional Approval Text	Certificate name
	CCC CNEX	CNCA-C23-01	2020312310000213 (Ex ec IIC T4 Gc)
	EAC Brjansker Zertifizierungsstelle	TP TC 020/2011	EAC RU C-DE.AM02. B.00087/19

Subject to changes. Please also observe the further product documentation!

	KC National Radio Research Agency	Article 58-2, Clause 3	MSIP-REM-W43-DIM750
	UL Underwriters Laboratories Inc. (ORDINARY LOCATIONS)	UL 508	E175199 Sec.1

Declarations of conformity and manufacturer's declarations

Logo	Approval	Additional Approval Text	Certificate name
	EU-Declaration of Conformity WAGO GmbH & Co. KG	-	-
	UK-Declaration of Conformity WAGO GmbH & Co. KG	-	-

Approvals for marine applications

Logo	Approval	Additional Approval Text	Certificate name
	ABS American Bureau of Shipping	-	22-2219060
	BSH Bundesamt fuer Seeschifffahrt und Hydrographie	-	1104
	BV Bureau Veritas S.A.	-	13453/E0 BV
	DNV DNV GL SE	DNV-CG-0339, Aug.2021	TAA0000194
	KR Korean Register of Shipping	-	KR HMB05880-AC001
	LR Lloyds Register EMEA	-	LR22180952TA

Subject to changes. Please also observe the further product documentation!

WAGO GmbH & Co. KG
Hansastr. 27
32423 Minden
Phone: +49571 887-0 | Fax: +49571 887-169
Email: info.de@wago.com | Web: www.wago.com

Do you have any questions about our products?
We are always happy to take your call at +49 (571) 887-44222.



PRS
Polski Rejestr Statków

-

TE/2236/880590
/19



RINA
RINA Germany GmbH

-

ELE343521XG001

Approvals for hazardous areas

Logo	Approval	Additional Approval Text	Certificate name
	<p>ATEX TUEV Nord Cert GmbH</p>	EN 60079-0	TUEV_14_ATEX_148929_X (II 3 G Ex ec IIC T4 Gc)
	<p>CCC CNEX</p>	CNCA-C23-01	2020312310000213 (Ex ec IIC T4 Gc)
	<p>EAC Brjansker Zertifizierungsstelle</p>	TP TC 012/2011	EAC RU C-DE.AM02.B.00163 /19 (2Ex nA IIC T4 Gc X)
	<p>IECEX TUEV Nord Cert GmbH</p>	IEC 60079-0	IECEX TUN 14.0035 X (Ex ec IIC T4 Gc)
	<p>INMETRO TÜV Rheinland do Brasil Ltda.</p>	IEC 60079-0	BR-Ex TÜV 12.1297 X
	<p>UKEx WAGO GmbH & Co. KG</p>	EN 60079-0	UKCA_WAGO22UKEX003X_ec
	<p>UL Underwriters Laboratories Inc. (HAZARDOUS LOCATIONS)</p>	UL 121201	E198726 Sec.1











Subject to changes. Please also observe the further product documentation!

WAGO GmbH & Co. KG
Hansastr. 27
32423 Minden
Phone: +49571 887-0 | Fax: +49571 887-169
Email: info.de@wago.com | Web: www.wago.com

Do you have any questions about our products?
We are always happy to take your call at +49 (571) 887-44222.

Optional accessories

Marking accessories

Marker carrier		
	Item no.: 750-103 Group marker carrier	www.wago.com/750-103
Marker		
	Item no.: 2009-145/000-006 Mini-WSB Inline; for Smart Printer; 1700 pieces on roll; stretchable 5 - 5.2 mm; plain; snap-on type; blue	www.wago.com/2009-145/000-006
	Item no.: 2009-145 Mini-WSB Inline; for Smart Printer; 1700 pieces on roll; stretchable 5 - 5.2 mm; plain; snap-on type; white	www.wago.com/2009-145
	Item no.: 2009-145/000-002 Mini-WSB Inline; for Smart Printer; 1700 pieces on roll; stretchable 5 - 5.2 mm; plain; snap-on type; yellow	www.wago.com/2009-145/000-002
	Item no.: 2009-145/000-007 Mini-WSB Inline; for Smart Printer; 1700 pieces on roll; stretchable 5 - 5.2 mm; plain; snap-on type; gray	www.wago.com/2009-145/000-007
	Item no.: 2009-145/000-005 Mini-WSB Inline; for Smart Printer; 1700 pieces on roll; stretchable 5 - 5.2 mm; plain; snap-on type; red	www.wago.com/2009-145/000-005
	Item no.: 2009-145/000-012 Mini-WSB Inline; for Smart Printer; 1700 pieces on roll; stretchable 5 - 5.2 mm; plain; snap-on type; orange	www.wago.com/2009-145/000-012
	Item no.: 2009-145/000-023 Mini-WSB Inline; for Smart Printer; 1700 pieces on roll; stretchable 5 - 5.2 mm; plain; snap-on type; green	www.wago.com/2009-145/000-023
	Item no.: 2009-145/000-024 Mini-WSB Inline; for Smart Printer; 1700 pieces on roll; stretchable 5 - 5.2 mm; plain; snap-on type; violet	www.wago.com/2009-145/000-024
	Item no.: 248-501/000-006 Mini-WSB marking card; as card; not stretchable; plain; snap-on type; blue	www.wago.com/248-501/000-006
	Item no.: 248-501/000-007 Mini-WSB marking card; as card; not stretchable; plain; snap-on type; gray	www.wago.com/248-501/000-007

Subject to changes. Please also observe the further product documentation!



Item no.: 248-501/000-002

Mini-WSB marking card; as card; not stretchable; plain; snap-on type; yellow

www.wago.com/248-501/000-002



Item no.: 248-501/000-012

Mini-WSB marking card; as card; not stretchable; plain; snap-on type; orange

www.wago.com/248-501/000-012



Item no.: 248-501

Mini-WSB marking card; as card; not stretchable; plain; snap-on type; white

www.wago.com/248-501



Item no.: 248-501/000-017

Mini-WSB marking card; as card; not stretchable; plain; snap-on type; light green

www.wago.com/248-501/000-017



Item no.: 248-501/000-005

Mini-WSB marking card; as card; not stretchable; plain; snap-on type; red

www.wago.com/248-501/000-005



Item no.: 248-501/000-024

Mini-WSB marking card; as card; not stretchable; plain; snap-on type; violet

www.wago.com/248-501/000-024



Item no.: 248-501/000-023

Mini-WSB marking card; as card; not stretchable; plain; snap-on type; green

www.wago.com/248-501/000-023



Item no.: 750-100

Marker card; as a DIN A4 sheet; plain

www.wago.com/750-100

Group marker carrier



Item no.: 750-106

Group marker carrier

www.wago.com/750-106

Carrier rail

Mounting accessories



Item no.: 210-197

Steel carrier rail; 35 x 15 mm; 1.5 mm thick; 2 m long; slotted; similar to EN 60715; silver-colored

www.wago.com/210-197

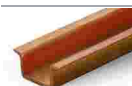

Item no.: 210-198

Copper carrier rail; 35 x 15 mm; 2.3 mm thick; 2 m long; unslotted; according to EN 60715; copper-colored

www.wago.com/210-198



Item no.: 210-504

Steel carrier rail; 35 x 7.5 mm; 1 mm thick; 2 m long; slotted; galvanized; according to EN 60715; silver-colored

www.wago.com/210-504

Subject to changes. Please also observe the further product documentation!

WAGO GmbH & Co. KG

Hansastr. 27









32423 Minden

Phone: +49571 887-0 | Fax: +49571 887-169





Email: info.de@wago.com | Web: www.wago.com

Do you have any questions about our products?



We are always happy to take your call at +49 (571) 887-44222.

	Item no.: 210-505 Steel carrier rail; 35 x 7.5 mm; 1 mm thick; 2 m long; unslotted; galvanized; according to EN 60715; silver-colored	www.wago.com/210-505
	Item no.: 210-506 Steel carrier rail; 35 x 15 mm; 1.5 mm thick; 2 m long; unslotted; galvanized; similar to EN 60715; silver-colored	www.wago.com/210-506
	Item no.: 210-508 Steel carrier rail; 35 x 15 mm; 1.5 mm thick; 2 m long; slotted; galvanized; similar to EN 60715; silver-colored	www.wago.com/210-508
	Item no.: 210-113 Steel carrier rail; 35 x 7.5 mm; 1 mm thick; 2 m long; unslotted; according to EN 60715; silver-colored	www.wago.com/210-113
	Item no.: 210-118 Steel carrier rail; 35 x 15 mm; 2.3 mm thick; 2 m long; unslotted; according to EN 60715; silver-colored	www.wago.com/210-118
	Item no.: 210-112 Steel carrier rail; 35 x 7.5 mm; 1 mm thick; 2 m long; slotted; according to EN 60715; "Hole width 25 mm; silver-colored	www.wago.com/210-112
	Item no.: 210-114 Steel carrier rail; 35 x 15 mm; 1.5 mm thick; 2 m long; unslotted; similar to EN 60715; silver-colored	www.wago.com/210-114
	Item no.: 210-115 Steel carrier rail; 35 x 7.5 mm; 1 mm thick; 2 m long; slotted; according to EN 60715; "Hole width 18 mm; silver-colored	www.wago.com/210-115
	Item no.: 210-196 Aluminum carrier rail; 35 x 8.2 mm; 1.6 mm thick; 2 m long; unslotted; similar to EN 60715; silver-colored	www.wago.com/210-196















Supply module

Supply module		
	Item no.: 750-601 Power Supply; 24 VDC; fuse holder	www.wago.com/750-601
	Item no.: 750-610 Power Supply; 24 VDC; fuse holder; Diagnostics	www.wago.com/750-610
	Item no.: 750-602 Power Supply; 24 VDC	www.wago.com/750-602
	Item no.: 750-612 Power Supply; 0 ... 230 V AC/DC	www.wago.com/750-612

Shield termination

Shield clamping saddles		
	Item no.: 790-116 Shield clamping saddle; 19 mm wide; diameter of compatible conductor; 7 ... 16 mm	www.wago.com/790-116
	Item no.: 790-124 Shield clamping saddle; 27 mm wide; diameter of compatible conductor; 6 ... 24 mm	www.wago.com/790-124

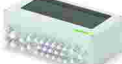
Subject to changes. Please also observe the further product documentation!

	Item no.: 790-108 Shield clamping saddle; 11 mm wide; diameter of compatible conductor; 3 ... 8 mm	www.wago.com/790-108
	Item no.: 790-140 Shield clamping saddle; diameter of compatible conductor	www.wago.com/790-140
	Item no.: 790-216 Shield clamping saddle; 21.8 mm wide; 6 ... 16 mm	www.wago.com/790-216
	Item no.: 790-220 Shield clamping saddle; 30 mm wide; 6 ... 20 mm	www.wago.com/790-220
	Item no.: 790-208 Shield clamping saddle; 12.4 mm wide; 3 ... 8 mm	www.wago.com/790-208
System housing		
System enclosure		
	Item no.: 850-814/002-000 IP65 enclosure; Sheet steel (RAL 7035); WxHxD (200x120x200 mm); without flange plate	www.wago.com/850-814/002-000
	Item no.: 850-815/002-000 IP65 enclosure; Sheet steel (RAL 7035); WxHxD (300x120x200 mm); without flange plate	www.wago.com/850-815/002-000
	Item no.: 850-816/002-000 IP65 enclosure; Sheet steel (RAL 7035); WxHxD (400x120x200 mm); without flange plate	www.wago.com/850-816/002-000
	Item no.: 850-817/002-000 IP65 enclosure; Sheet steel (RAL 7035); WxHxD (600x120x200 mm); without flange plate	www.wago.com/850-817/002-000
	Item no.: 850-825 IP65 enclosure; Aluminium (RAL 7032); WxHxD (160x100x160 mm); 9 x M12, 4 x M20	www.wago.com/850-825
	Item no.: 850-826 IP65 enclosure; Aluminium (RAL 7032); WxHxD (240x100x160 mm); 4 x M20, 4 x M16, 14 x M12 cable grip	www.wago.com/850-826
	Item no.: 850-827 IP65 enclosure; Aluminium (RAL 7032); WxHxD (320x100x160 mm); 4 x M20, 8 x M16, 17 x M12 cable grip	www.wago.com/850-827
	Item no.: 850-827/002-000 IP65 enclosure; Aluminium (RAL 7035); WxHxD (320x100x160 mm); 4 x M20, 8 x M16, 17 x M12 cable grip	www.wago.com/850-827/002-000
	Item no.: 850-826/002-000 IP65 enclosure; Aluminium (RAL 7035); WxHxD (240x100x160 mm); 4 x M20, 4 x M16, 14 x M12 cable grip	www.wago.com/850-826/002-000
	Item no.: 850-828/002-000	

Subject to changes. Please also observe the further product documentation!



IP65 enclosure; Aluminium (RAL 7035); WxHxD (480x100x160 mm); 4 x M20, 10 x M16, 35 x M12 cable grip

www.wago.com/850-828/002-000



Item no.: 850-828

IP65 enclosure; Aluminium (RAL 7032); WxHxD (480x100x160 mm); 4 x M20, 10 x M16, 35 x M12 cable grip

www.wago.com/850-828



Item no.: 850-834

IP65 enclosure; Polyester (RAL 7032); WxHxD (164x100x164 mm); 9 x M12, 4 x M20

www.wago.com/850-834



Item no.: 850-835

IP65 enclosure; Polyester (RAL 7032); WxHxD (244x100x164 mm); 4 x M20, 4 x M16, 14 x M12 cable grip

www.wago.com/850-835



Item no.: 850-836

IP65 enclosure; Polyester (RAL 7032); WxHxD (324x100x164 mm); 4 x M20, 8 x M16, 17 x M12 cable grip

www.wago.com/850-836

Downloads

Documentation

Manual

System Manual WAGO I/O System 750/753 Decentralized Automation Technology	V 3.3.0 2023 May 4	pdf 8.8 MB	Download
Product Manual 2-channel, 24VDC, 3.0ms 2- to 4-wire connection; high-side switching	V 2.0.0 2022 Sep 7	pdf 2.9 MB	Download
System Manual Series 750/753 Online HTML		URL	Download

Bid Text

750-400 X81 - Datei	2019 Feb 19	xml 4.1 kB	Download
750-400 doc - Datei	2017 Jul 12	doc 25.1 kB	Download
ausschreiben.de 750-400		URL	Download

Instruction Leaflet

CCC Ex (Additional information) WAGO-I/O-SYSTEM *750-****/*	2023 Apr 26	pdf 163.6 kB	Download
--	-------------	-----------------	----------

Subject to changes. Please also observe the further product documentation!



System Description

Overview on WAGO-I/O-SYSTEM 750 approvals		pdf 789.0 kB	Download
750/753 Series I/O-System – General Product Information		pdf 1.7 MB	Download

Additional Information

Disposal and Recycling	V 1.1.0	pdf	Download
Electrical and electronic equipment, Batteries, Packaging	2022 Aug 18	2.2 MB	

CAD/CAE-Data

CAD data

2D/3D Models 750-400		URL	Download
----------------------	--	-----	----------

CAE data

EPLAN Data Portal 750-400		URL	Download
WSCAD Universe 750-400		URL	Download
ZUKEN Portal 750-400		URL	Download

Device Files

Device Driver

WAGO USB Service Kabel Treiber / Serie 750 und 857	6.5.3.0 2014 Sep 10	zip 4.8 MB	Download
--	------------------------	---------------	----------

Environmental Product Compliance

Compliance Search

Environmental Product Compliance 750-400 2-channel digital input; 24 VDC; 3 ms		URL	Download
---	--	-----	----------

Subject to changes. Please also observe the further product documentation!

Data sheet | Item number: 750-400

www.wago.com/750-400



Installation Notes

Product family

WAGO I/O System 750/753

[Show all products from the family](#)

Subject to changes. Please also observe the further product documentation!

WAGO GmbH & Co. KG

Hansastr. 27

32423 Minden

Phone: +49571 887-0 | Fax: +49571 887-169

Email: info.de@wago.com | Web: www.wago.com

Do you have any questions about our products?

We are always happy to take your call at +49 (571) 887-44222.