

# **AT73C246-EK1 Evaluation Kit**

---

## **User Guide**





---

## Section 1

Introduction .....	1-1
1.1 Scope .....	1-1
1.1.1 Typical Applications: .....	1-1
1.2 AT73C246-EK1 Features .....	1-2
1.3 Deliverables .....	1-3

---

## Section 2

Getting Started.....	2-1
2.1 Electrostatic Warning .....	2-1
2.2 Requirements.....	2-1
2.3 PC System Requirements.....	2-1
2.4 Instructions.....	2-2
2.4.1 To start the AT73C246-EK1 board (before using the AT73C246-EK1 software) .....	2-2
2.4.2 To turn off the AT73C246-EK1 evaluation board.....	2-2
2.5 Block Diagram.....	2-3
2.6 Power Supply .....	2-4
2.7 Communication Interfaces .....	2-5
2.7.1 Communication Interfaces Header (J15) .....	2-5
2.8 Audio Interfaces .....	2-6
2.9 Output Voltages .....	2-7
2.10 Input/Output Signals.....	2-8
2.10.1 ADC .....	2-8
2.10.2 CLK32K - RTC Output Clock .....	2-8
2.10.3 LED.....	2-8
2.10.4 Wakeup Push Buttons .....	2-9
2.10.5 LDOs Optional Programming Enable .....	2-9

---

## Section 3

AT73C246-EK1 Software Interface .....	3-1
3.1 Software Panel.....	3-1
3.1.1 Login .....	3-1
3.1.2 Login Errors .....	3-1
3.1.3 Functionality and Control Pages.....	3-3

---

## Section 4

USB-to-Serial Card .....	4-1
4.1 USB-to-Serial Card Features .....	4-1
4.2 Electrostatic Warning .....	4-1
4.3 Requirements.....	4-1
4.4 Instructions.....	4-2

4.4.1	To start the USB-to-Serial Card (after software installation).....	4-2
4.4.2	To turn off the USB-to-Serial Card.....	4-2
4.5	Identification LEDs .....	4-2
4.6	Serial Interfaces Header .....	4-3

---

### **Section 5**

Technical Specifications .....	5-1
5.1 AT73C246-EK1 .....	5-1

---

### **Section 6**

PCB Layout.....	6-1
6.1 AT73C246-EK1 .....	6-1

---

### **Section 7**

Schematics .....	7-1
------------------	-----

---

### **Section 8**

Revision History.....	8-1
8.1 Revision History .....	8-1





## Section 1

---

# Introduction

Congratulations on your purchase of the AT73C246-EK1. It is designed to give designers a quick start to evaluate the power management and audio capability of the AT73C246 and for prototyping and testing of new designs.

---

### 1.1 Scope

This document describes the AT73C246-EK1. This board is designed to allow an easy evaluation of the products using demonstration software.

To increase its capabilities for demonstration, this standalone board has two serial interfaces (TWI and I<sup>2</sup>S via a dedicated connector), Manual Startup/Reset Control, Input/Audio Connectors, 4 x ADC Inputs, RTC and Output Supply Voltages Terminals.

This user guide acts as a general getting started guide as well as a complete technical reference for advanced users.

This document refers the AT73C246 datasheet.

#### 1.1.1 Typical Applications:

- Portable devices

---

## 1.2 AT73C246-EK1 Features

The AT73C246-EK1 provides the following features:

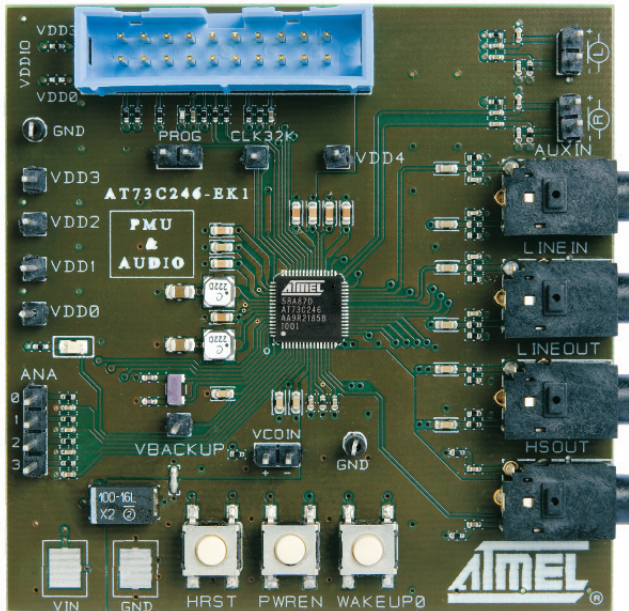
- Small size (only 70 x 70mm) with maximum available features.
- Input power supply:
  - External Power Supply on VIn pad (2.5V to 5.5V).
- On-board audio/analog resources:
  - 100dB Dynamic Range Stereo Audio DAC - 8 to 96 kHz sampling frequency,
  - 4 x 96dB Dynamic Range Stereo Audio ADC - 8 to 96 kHz sampling frequency,
  - 1 stereo 16/32 Ohm/20mW stereo headset (3.5mm jack connector),
  - 1 stereo line in (3.5mm jack connector),
  - 1 auxiliary in (3.5mm jack connector),
  - 1 stereo line output (3.5mm jack connector),
  - Stereo microphone inputs with bias generator,
- On-board power supply resources:
  - DCDC0 : 0.8 - 3.6V / 600mA,
  - DCDC1 : 0.8 - 3.6V / 600mA,
  - LDO2 : 0.8 - 1.9V / 300mA,
  - LDO3 : 2.7 - 3.6V / 200mA,
  - LDO4 : 2.7 - 3.6V / 200mA,
  - LDO5 : 2.5V / 10mA - Backup battery charger and RTC supply,
- Serial interfaces:
  - TWI for PMU and Audio controls,
  - I<sup>2</sup>S Master / Slave protocol support (for audio streaming),
- RTC 32KHz output for host support.
- Reset and Interrupt generation.
- On-board buttons:
  - Power Enable (PWREN),
  - Hard Reset (HRST),
  - Wakeup Sequence (WAKEUP0).

## 1.3 Deliverables

The AT73C246-EK1 package contains the following items:

1. An AT73C246-EK1 board,

**Figure 1-1.** AT73C246-EK1 Top View (card photo)

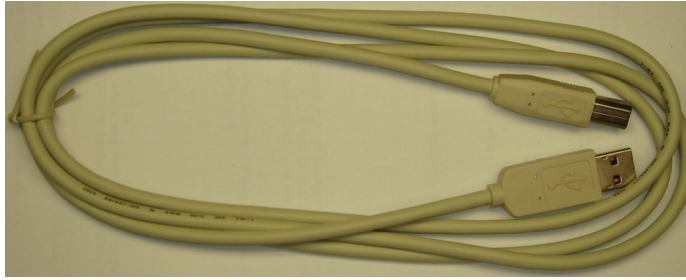


The AT73C246 is located in the center of the AT73C246-EK1 on the Components Side.

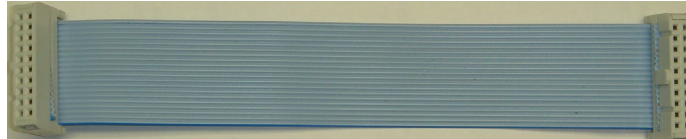
2. USB Interface card,



3. USB cable,



4. 20-pins flat cable,

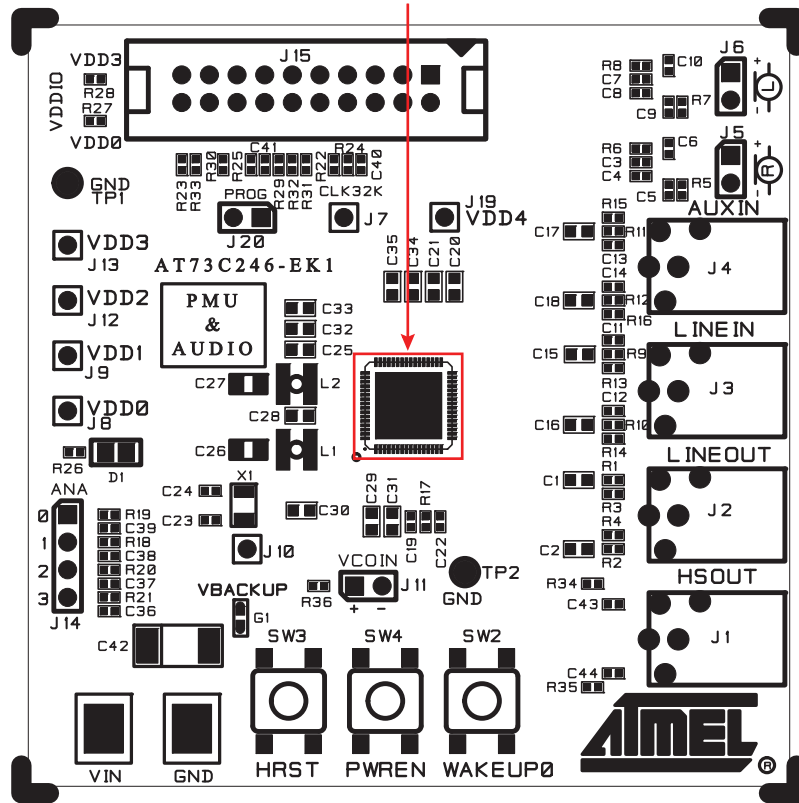


5. One CD-ROM containing the product's user guide, full datasheet and ready to use GUI and Command line applications.





Figure 1-2. AT73C246-EK1 Components Side







## Section 2

---

# Getting Started

---

### 2.1 Electrostatic Warning

The AT73C246-EK1 evaluation board is shipped in protective anti-static packaging. The board must not be subjected to high electrostatic potentials. A grounding strap or similar protective device should be connected when handling the board. Avoid touching the components pins or any metallic element.

### 2.2 Requirements

In order to set up the AT73C246-EK1 evaluation kit the following items are needed:

1. The AT73C246-EK1 evaluation board itself.
2. A DC 2.9V to 5.5V, connected to Vin pad, output power source for main supply (minimum 1 A are required for fully operation).
3. The USB interface card with its USB cable and 20-pins flat cable.
4. Input/Output devices (Headset, Microphone, etc)
5. PC station with a USB connection (i.e. Universal Serial Bus) for command communication (via USB interface card).

### 2.3 PC System Requirements

For a correct software operation of the AT73C246-EK1 evaluation board, the minimum hardware and software PC requirements are:

- Intel Pentium II processor
- 64 MB RAM
- 70 MB free hard disk space (for AT73C246 Evaluation board software installation)
- Windows® 2000/XP/VISTA
- A USB connection.

---

## 2.4 Instructions

### 2.4.1 To start the AT73C246-EK1 board (before using the AT73C246-EK1 software)

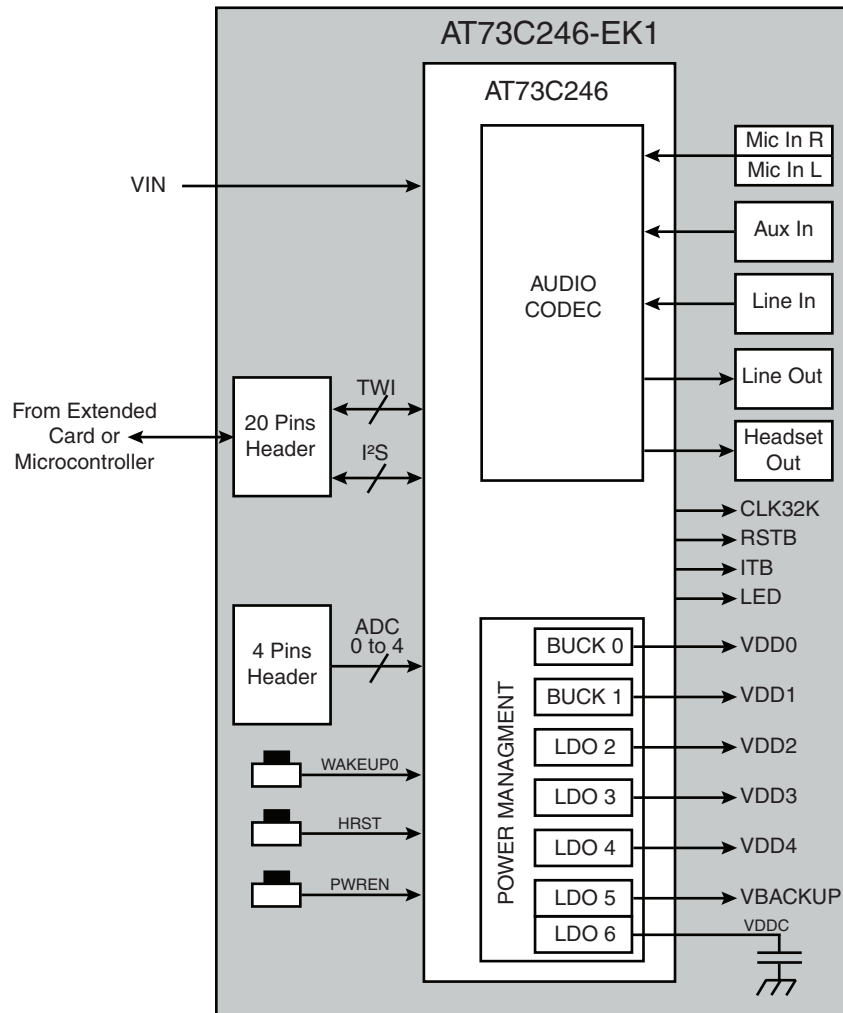
- Install the AT73C246 software by clicking on setup.exe.
- If the software is downloaded from the Atmel Web site then it is necessary to install first the National Instrument Labview software (LabVIEW8.0.1RuntimeEngine).
- Connect Input and Output devices to the AT73C246-EK1 board (into linein, Headset, Microphone, etc..) as in [Section 2.8 "Audio Interfaces" on page 2-6](#),
- Connect DC power supply on P1 and P2.
- Connect the USB cable between the PC and the USB Interface card and when the PC requests an "inf" driver point to "CompositeCDCSerial.inf" in USB Driver folder,
- Connect the 20-pins flat cable between the to USB Interface card header and the AT73C246-EK1 board.
- Launch the AT73C246 software test interface by clicking on AT73C246.exe (and follow instructions in ["AT73C246-EK1 Software Interface" on page 3-1](#) and ["USB-to-Serial Card" on page 4-1](#))
- Push once on PWREN button (the AT73C246-EK1 on-board ["LED \(D1\)"](#) should blink)

### 2.4.2 To turn off the AT73C246-EK1 evaluation board

- Disconnect the 20-pins flat cable,
- Disconnect the power supply on P1 and P2.

## 2.5 Block Diagram

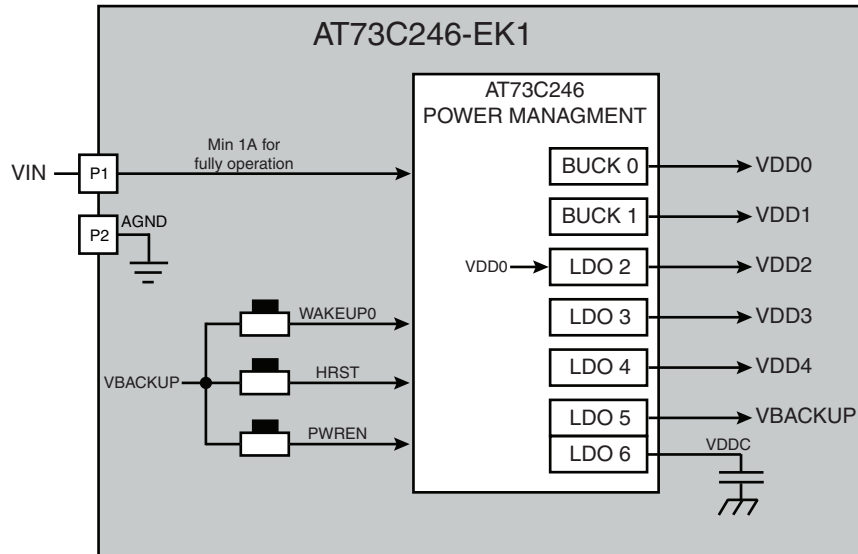
Figure 2-1. AT73C246-EK1 Block Diagram



## 2.6 Power Supply

The AT73C246-EK1 is supplied by an external power supply connected on P1 (positive supply) and P2 (ground).

**Figure 2-2.** Power Supply Diagram

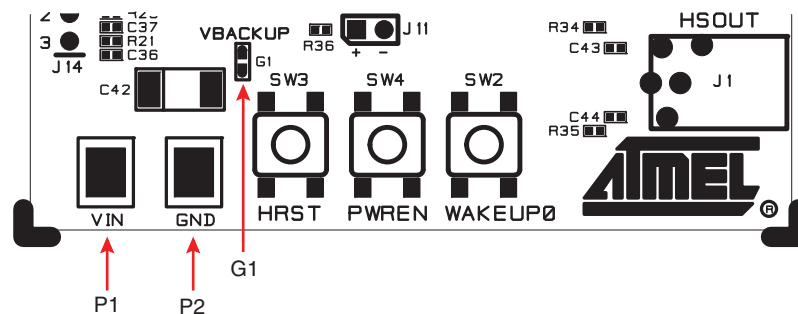


**Table 2-1.** Electrical Supply Requirements

Power supply source	Min	Max	Unit
On P1 pad (minimum 1 A for fully operation)	3.1	5.5	V

**Note:** This power supply input is NOT protected against polarization inversion.

**Figure 2-3.** Vin Supply Pad (P1 & P2)



Connect the power supply (+) to P1 and the ground (-) to P2.

**Note:** Keep G1 soldered to insure connection between the AGND (analog ground on P2) and DGND (digital ground).

## 2.7 Communication Interfaces

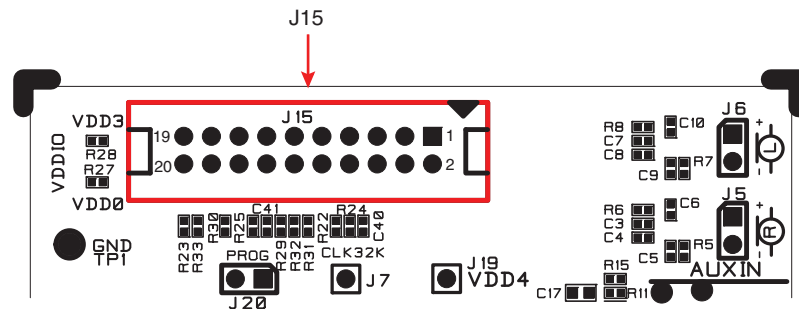
### 2.7.1 Communication Interfaces Header (J15)

The following table details the pin assignments for each signal. All signal, I<sup>2</sup>S or TWI, are processed by the USB-to-Serial module. If needed the user can drive directly these signals (using a microcontroller for example) through J15.

**Table 2-2.** Communication Interface Header Pins Assigning

Pin N°	Signal Name	Description	Pin N°	Signal Name	Description
1	WAKEUP3	-	2	Vin	Not Used
3	WAKEUP2	-	4	DGND	Digital Ground
5	WAKEUP1	-	6	-	Not Used
7	RSTB	Component Reset	8	DGND	Digital Ground
9	TWCK	TWI Clock	10	VDDIO	I/O level
11	LRFS-Signal	I <sup>2</sup> S Frame Clock	12	MCLK	I <sup>2</sup> S Master Clock
13	DAI-Signal	I <sup>2</sup> S Data in	14	ITB	Interrupt
15	DAO-Signal	I <sup>2</sup> S Data out	16	-	Not Used
17	BCLK-Signal	I <sup>2</sup> S Bit Clock	18	-	Not Used
19	-	Not Used	20	TWD	TWI Data I/O

**Figure 2-4.** Communication Interfaces Header (J15)



**Note:** For a reason of I/O level configuration between the AT73C246 and an external microcontroller and If using another interface then the USB Communication Box, the VDD3 or VDD0 should be connect on J15 by soldering a 0 ohms resistor on its pads (see VPAD Selection “AT73C246-EK1 Schematic - Power Supply Page” on page 7-5).

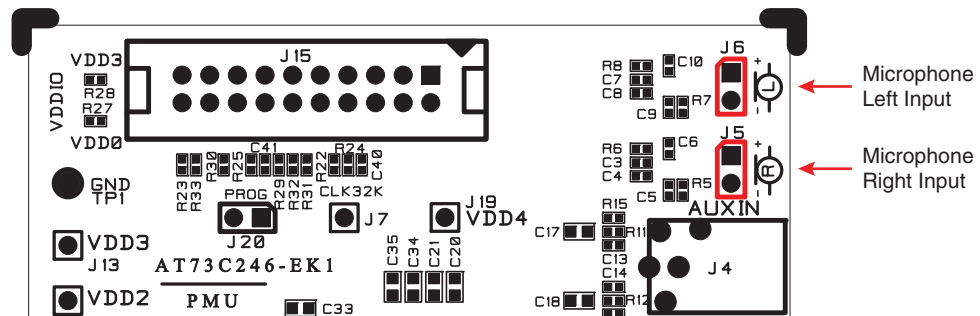
## 2.8 Audio Interfaces

The AT73C246-EK1 CODEC interface contains various connections of audio elements:

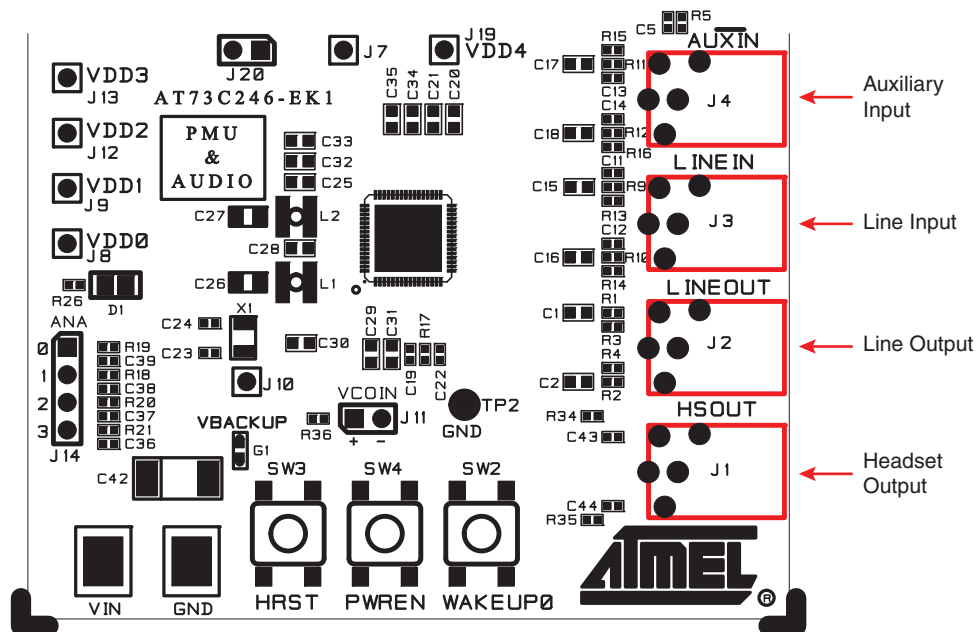
- Microphones Inputs connected to J5 and J6 (2 pins header for each input).
- Auxiliary Input connected to J4 (3.5mm jack).
- Line Input connected to J3 (3.5mm jack).
- Line Output connected to J2 (3.5mm jack).
- Headset Output connected to J1(3.5mm jack).

Please consult the product data sheet for setup options and requirements.

**Figure 2-5.** Microphones Inputs (J5 and J6)



**Figure 2-6.** Audio Inputs and Outputs (J1, J2, J3 and J4)





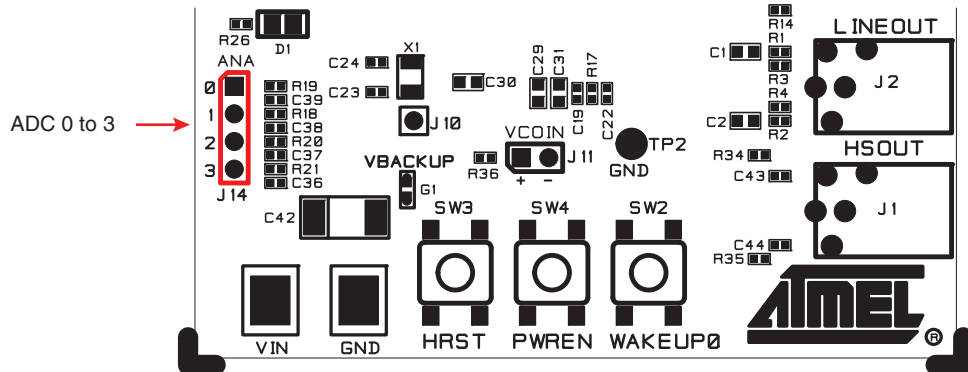


## 2.10 Input/Output Signals

### 2.10.1 ADC

Connect an external analog signal to ADC connector J14.

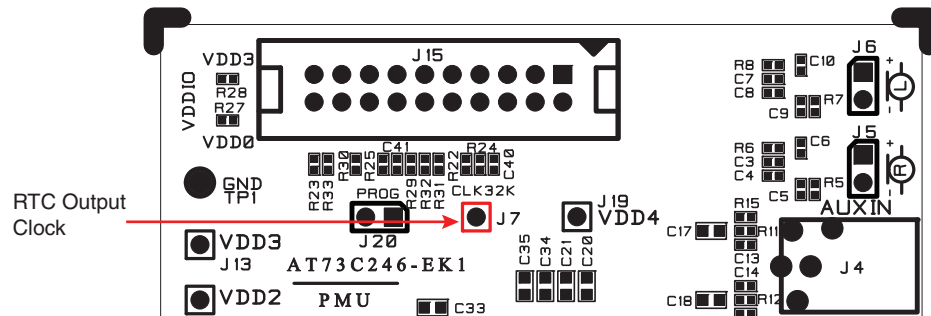
**Figure 2-9.** ADC connector (J14)



### 2.10.2 CLK32K - RTC Output Clock

The AT73C246-EK1 provides measuring the internal oscillator frequency (J7).

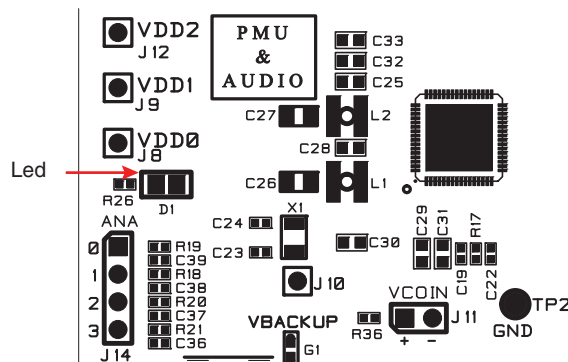
**Figure 2-10.** CLK32K (J7)



### 2.10.3 LED

The programmable output LED pin can be visualized by the on board led (D1).

**Figure 2-11.** LED (D1)



## 2.10.4 Wakeup Push Buttons

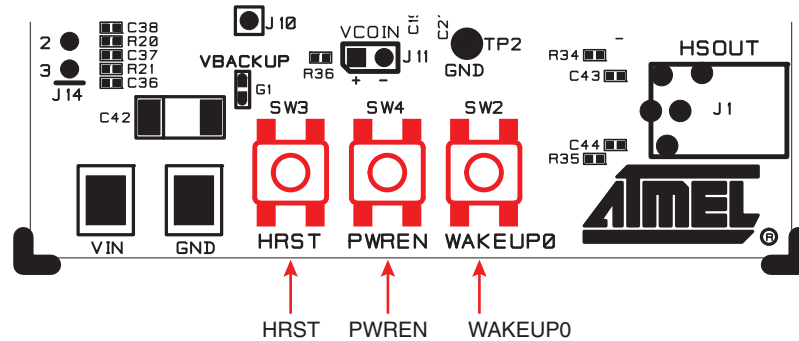
The AT73C246-EK1 provides 3 on board wakeup push buttons for startup/shutdown operations.

HRST - Pressing it for 1 second reset the AT73C246 (when the AT73C246 in "ON").

PWREN - Pressing it for 5 sec start/stop the AT73C246.

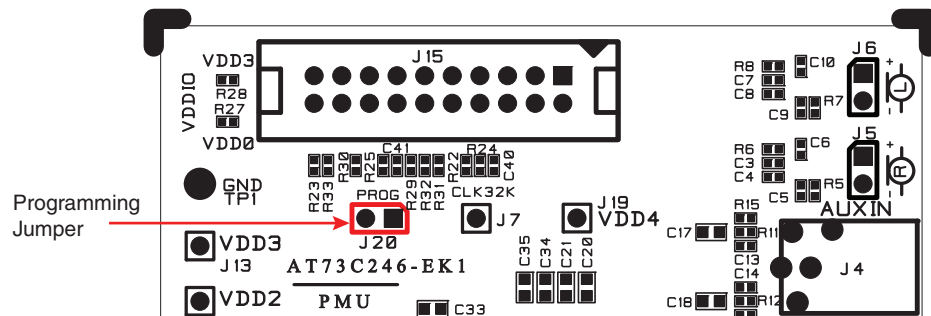
WAKEUP0 - Pressing it once enable the sequence in PMU\_WAKEUP\_EVENTMENT register. On the other hand, when the AT73C246 in "ON", pressing it for 1 second switch the AT73C246 into standby mode.

**Figure 2-12.** Wakeup Push Buttons (SW2, SW3 and SW4)



## 2.10.5 LDOs Optional Programming Enable

Close J20 before any access to the state machine LDOs startup sequences.





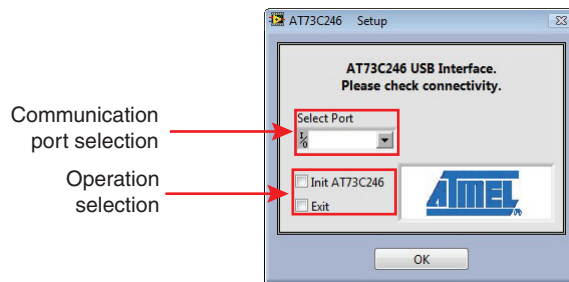
# AT73C246-EK1 Software Interface

## 3.1 Software Panel

### 3.1.1 Login

1. Connect the USB cable to the USB Interface card and check which COM it uses. Go to Device Manager in the Control Panel of your computer and then look for “AT91 USB to Serial Converter” title in PORTS.
2. On setup panel - Select Port and required operation: Init AT73C246 for initializing card or Exit program.

**Figure 3-1.** Login Message



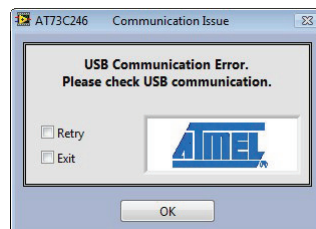
### 3.1.2 Login Errors

#### USB Communication Issue

In software startup - In case of “Communication Issue” check USB cable connectivity and/or COM selection.

Then, select Retry or Exit.

**Figure 3-2.** Communication Error

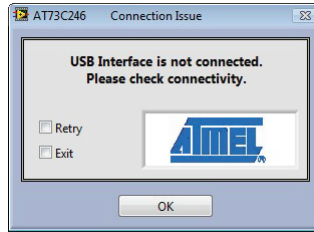


### **USB Connection Issue**

While software runs - In case of “Connection Issue” check USB cable connectivity.

Then, select Retry or Exit.

**Figure 3-3.** Connection Issue

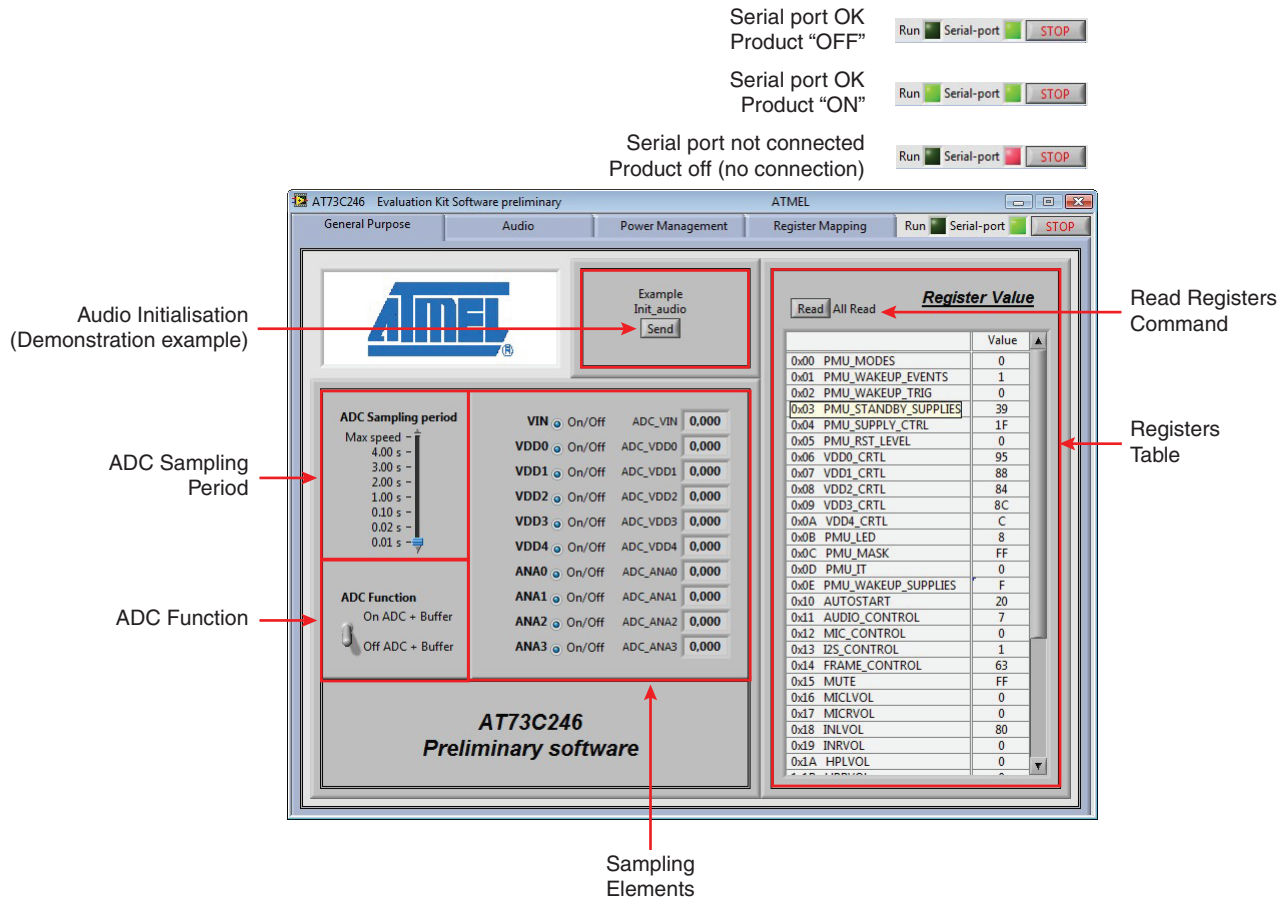


### 3.1.3 Functionality and Control Pages

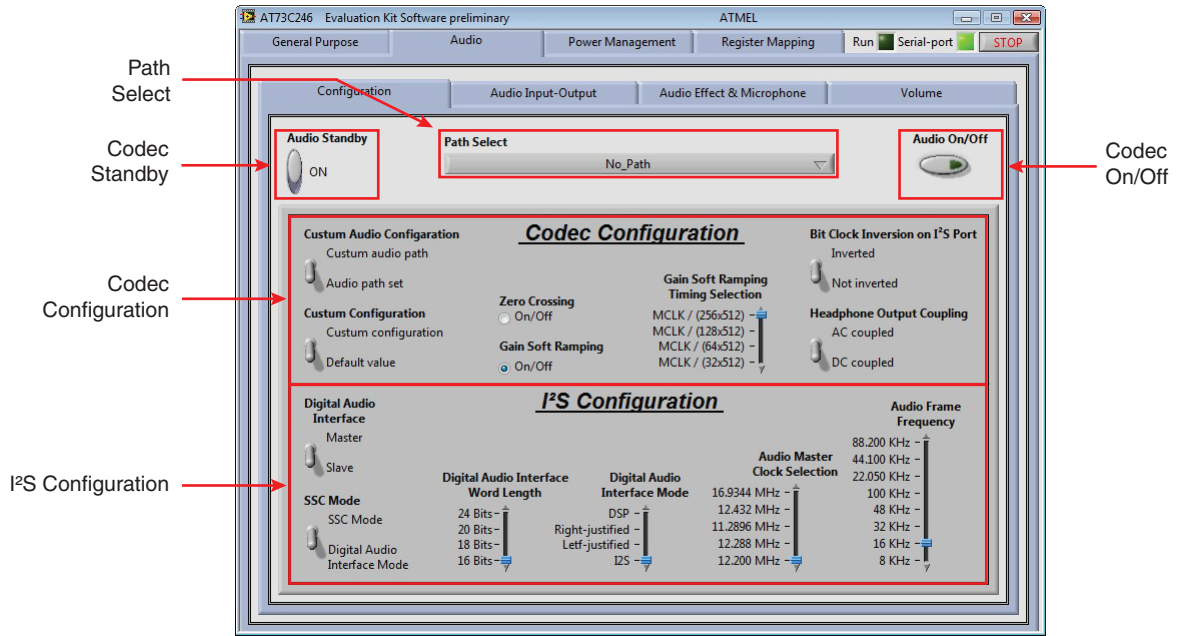
AT startup (after pressing on WAKEUP button) the user can choose to initialize by clicking on “Example Init\_audio” button (the initialization can be done manually or programmed by microcontroller). This action will startup the following elements:

- Audio Codec - for this example the first path is chosen - “Digital In - Headphone Out”.
- Power Management Unit
- Blinking Led

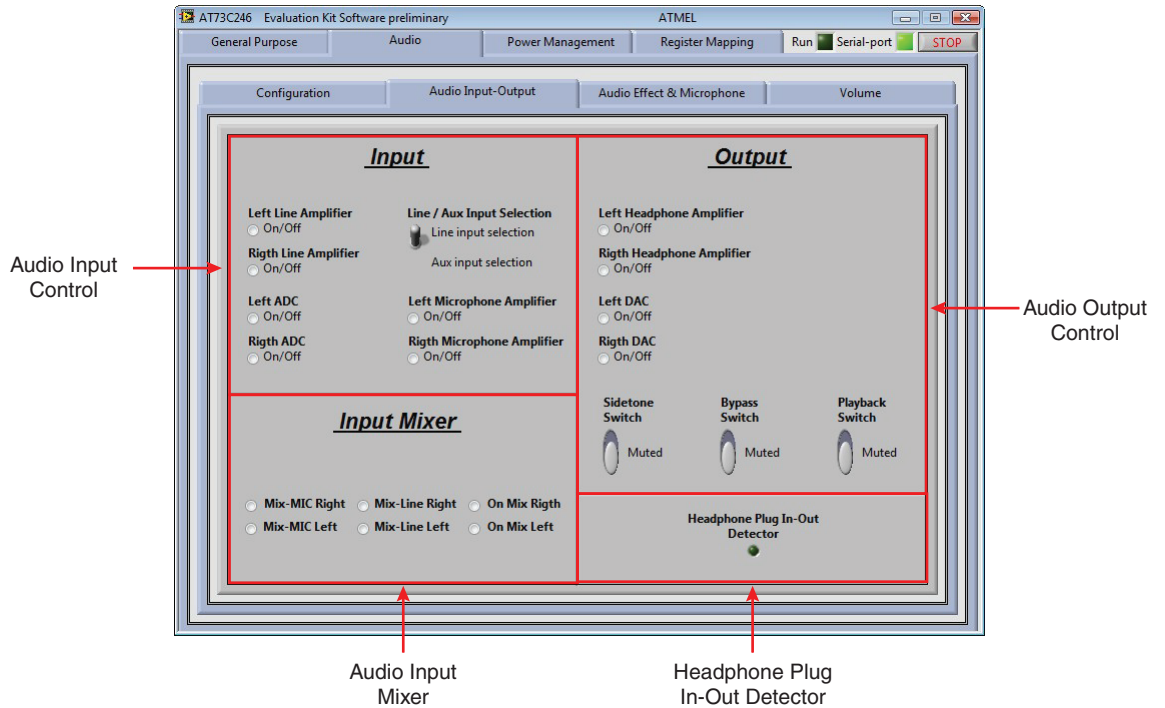
**Figure 3-4.** Software Panel - General Purpose



**Figure 3-5.** Software Panel - Audio Configuration

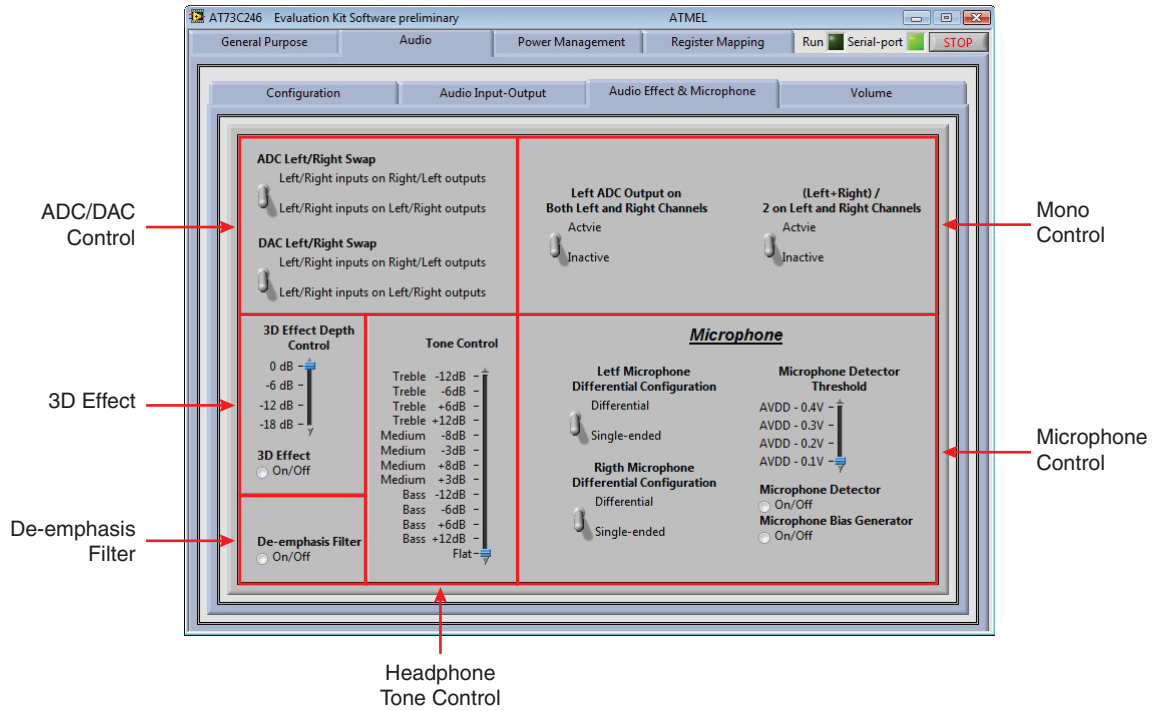


**Figure 3-6.** Software Panel - Audio Input-Output

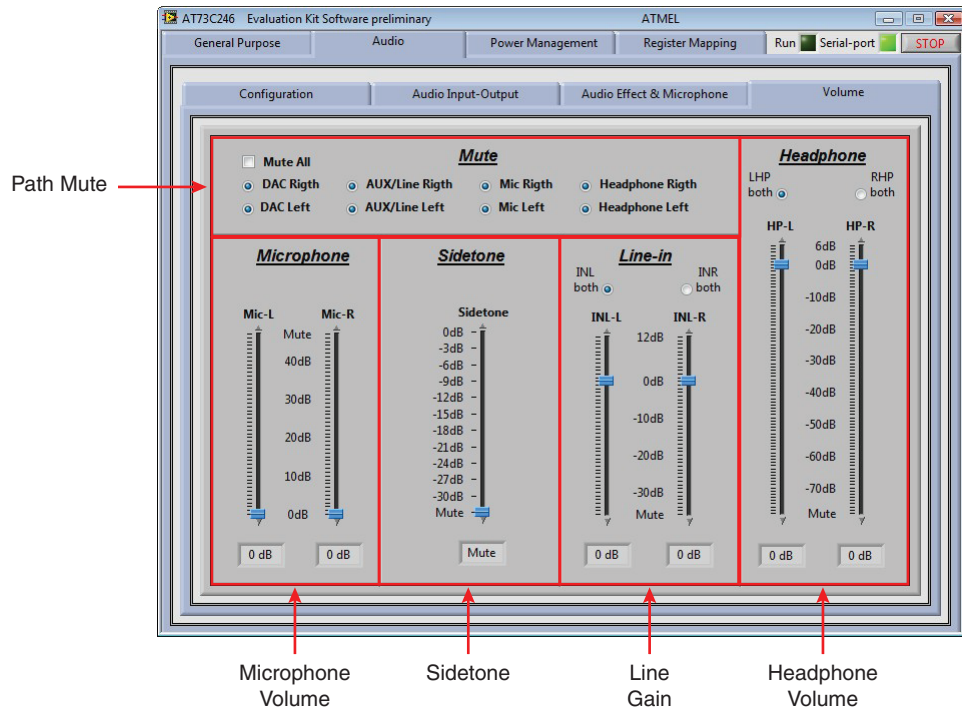




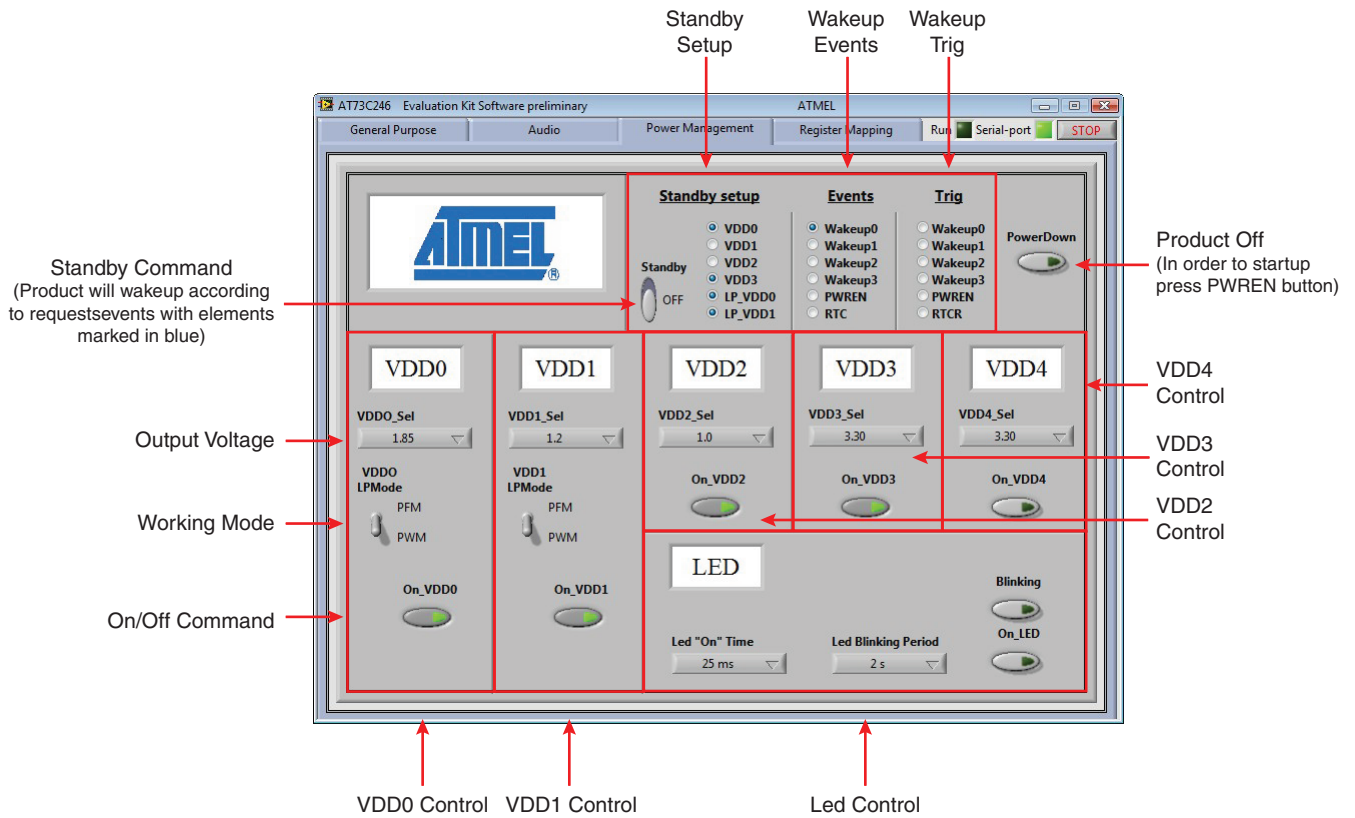
**Figure 3-7.** Software Panel - Audio Effect & Microphone



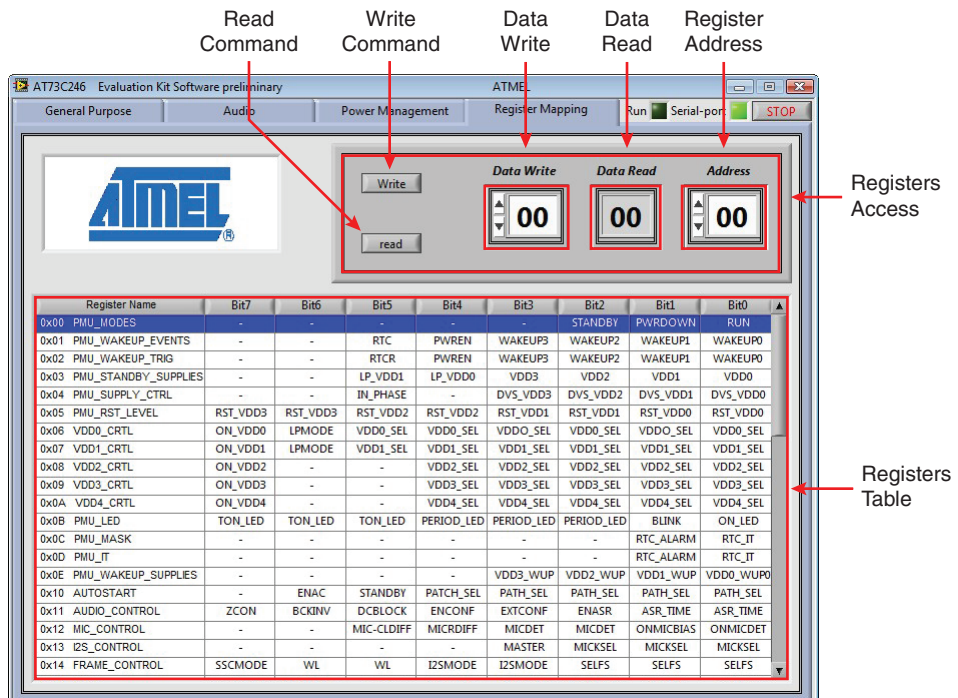
**Figure 3-8.** Software Panel - Audio Volume



**Figure 3-9. Software Panel - Power Management**



**Figure 3-10. Software Panel - Register Mapping**





## Section 4

---

# USB-to-Serial Card

The USB-to-Serial Card provides computer terminals to communicate with all PMAAC product line.

It gives designers all necessary for a quick setup of an evaluation card and it supports different product's software.

To increase its capabilities for demonstration, this standalone board has 3 serial interfaces (I<sup>2</sup>S, TWI and SPI).

---

### 4.1 USB-to-Serial Card Features

The USB-to-Serial Card provides the following features:

- On-board resources:
  - Standard USB interface,
  - 20 leads GPIO connector,
  - 12.288MHz Clock output for digital core,
- Serial interfaces:
  - Bidirectional buffered USB to SPI
  - Bidirectional buffered USB to TWI
  - Bidirectional buffered USB to I<sup>2</sup>S
- On-board indication leds:
  - Power “ON”
  - Data transmitting

---

### 4.2 Electrostatic Warning

The USB-to-Serial Card evaluation board is shipped in protective plastic packaging. The board must not be subjected to high electrostatic potentials. Avoid touching the components pins or any metallic element.

---

### 4.3 Requirements

In order to set up the USB-to-Serial Card the following items are needed:

1. The USB-to-Serial Card itself.
2. PC station with a standard USB connector.
3. The 20-leads flat cable.

---

## 4.4 Instructions

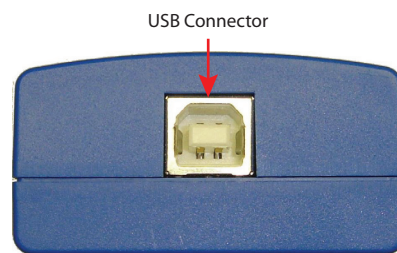
### 4.4.1 To start the USB-to-Serial Card (after software installation)

- Connect the USB cable to the USB-to-Serial Card and verify led color is green and constant,
- Connect the 20-pins flat cable between the to USB-to-Serial Card and the evaluation board.
- Once the USB-to-Serial Card properly installed; it should operate transparently - as if it were a standard cable connection. There is no ON/OFF switch and all data signals from and to the PC are passed straight through.

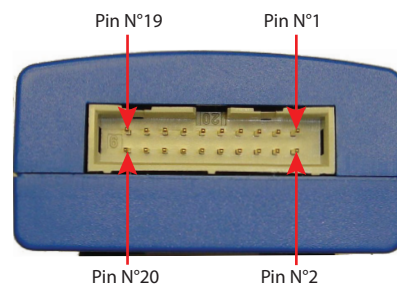
### 4.4.2 To turn off the USB-to-Serial Card

Disconnect the USB cable.

**Figure 4-1.** USB Side



**Figure 4-2.** GPIO Side



---

## 4.5 Identification LEDs

The bi color LED identify the following statuses:

- Continuous Green - Power “ON”
- Blinking Red - Data transmitting

## 4.6 Serial Interfaces Header

The USB-to-Serial Card supports I<sup>2</sup>S, SPI and TWI protocols which configured automatically by the software. The following table details the pins assigning for each signal on the GPIO connector (2x10 pins header Type HE10 for flat cable).

**Note:** In most cases, a clock must run during any I<sup>2</sup>S, SPI or TWI write access. In any case of not using the Serial Board and connecting an external communication system for I<sup>2</sup>S, SPI or TWI a clock should be provided to the supported evaluation card.

**Table 4-1.** Serial Interface Header Pins Assigning

Pin N°	Signal Name	Description	Pin N°	Signal Name	Description
1	MOSI	SPI Data out <sup>(1)</sup>	2	ADJ_VOUT	Not Used
3	SPCK	SPI CLK <sup>(1)</sup>	4	GND	Ground <sup>(4)</sup>
5	NPCS1	SPI Chip Select 1 <sup>(1)</sup>	6	+3V3	Not Used
7	NPCS0	SPI Chip Select 0 <sup>(1)</sup>	8	GND	Ground <sup>(4)</sup>
9	TWCK	TWI CLK <sup>(1)</sup>	10	Vin_VDDIO	Input supply from supported card <sup>(2)</sup>
11	LRFS	I <sup>2</sup> S Frame Clock <sup>(1)</sup>	12	MCLK	12.288MHz Output clock for supported digital core <sup>(1)(5)</sup>
13	SDIN_Codec	I <sup>2</sup> S Data in <sup>(2)</sup>	14	IRQ	Interrupt Request
15	SDOUT_Codec	I <sup>2</sup> S Data out <sup>(1)</sup>	16	nRST_in	Reset in <sup>(2)</sup>
17	BCLK_Codec	I <sup>2</sup> S Bit Clock <sup>(1)</sup>	18	MISO	SPI Data in <sup>(2)</sup>
19	AD4	Not Used	20	TWD	TWI Data <sup>(3)</sup>

- Notes:**
1. An output signal from USB-to-Serial Card to supported card.
  2. An input signal from supported card to USB-to-Serial Card.
  3. A Bi-directional signal.
  4. Ground - These pins must be connected between the USB-to-Serial Card and the supported board.
  5. 12.288 MHz Clock - The USB-to-Serial Card's oscillator provides a 12.288MHz clock (+3.3V p-p via pin 12). This clock is necessary for driving the digital core of the evaluated board.





---

**Technical Specifications**

---

**5.1 AT73C246-EK1**

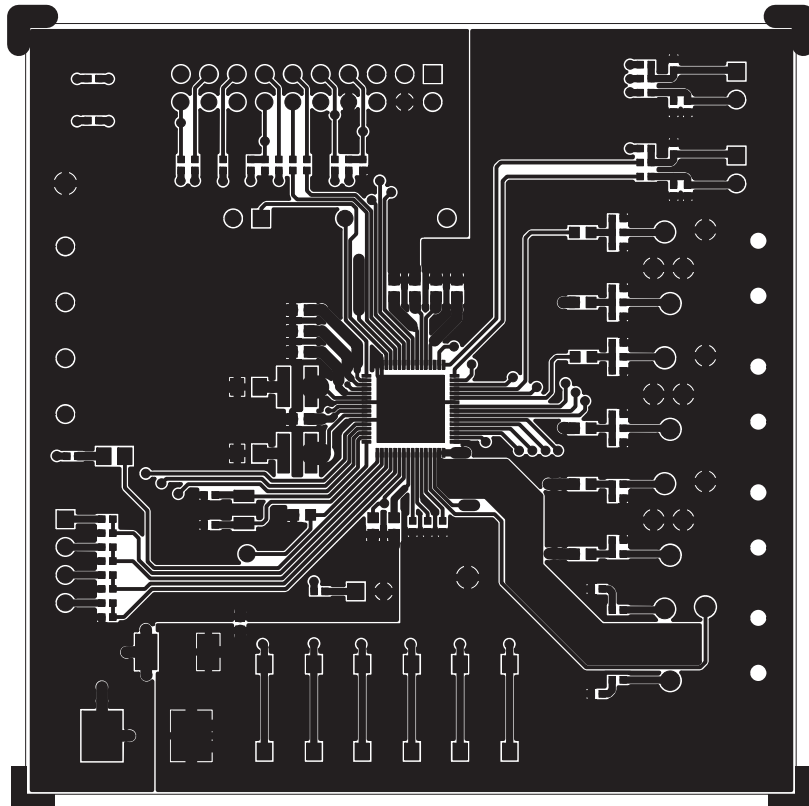
- System Unit: AT73C246-EK1
  - **Physical Dimensions**..... L= 70 x W=70 x H=20 mm
  - **Weight**.....70 g
- Operating Conditions
  - **External Voltage Supply (on Vin Pad)**..... 2.9V - 5.5V
- Connections
  - **Communication Connector (for I<sup>2</sup>S and TWI)**.....2x10 pins Header





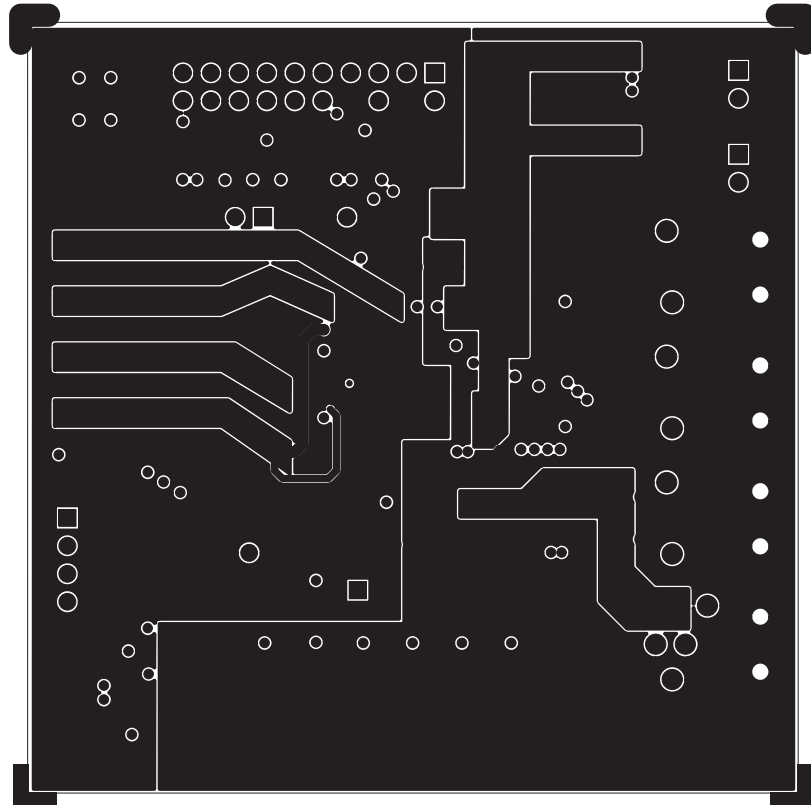
6.1 AT73C246-EK1

Figure 6-1. Layer 1 - Components Layer



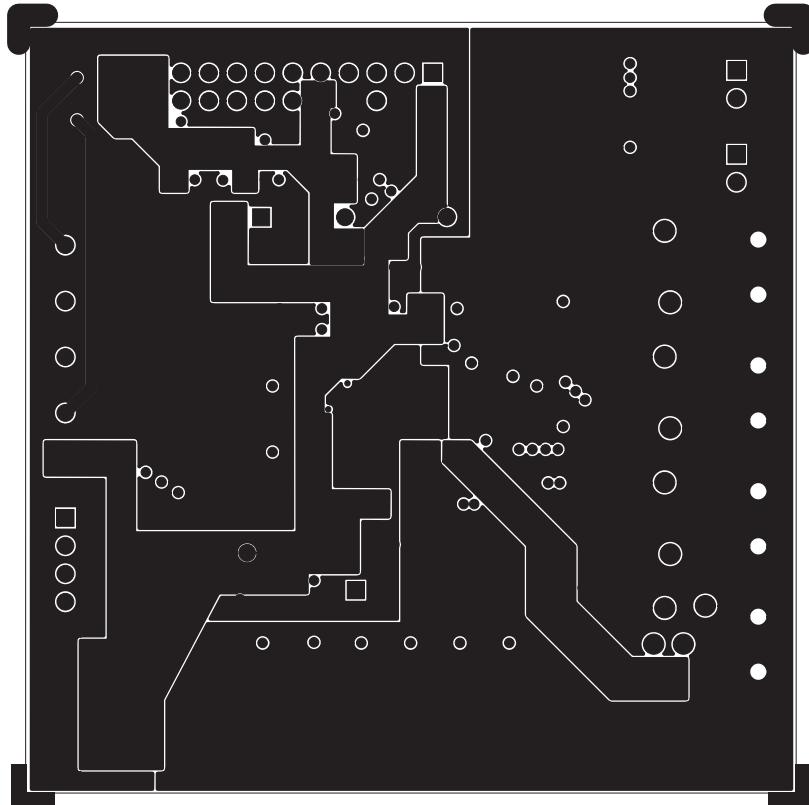
**Note:** Size not to scale

**Figure 6-2.** Layer 2



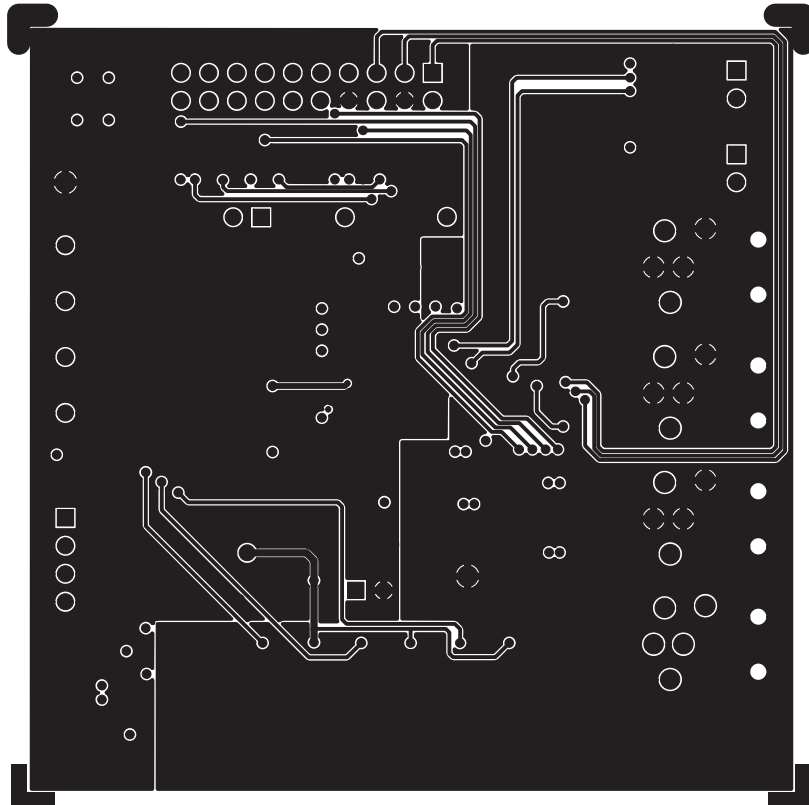
**Note:** Size not to scale

**Figure 6-3.** Layer 3



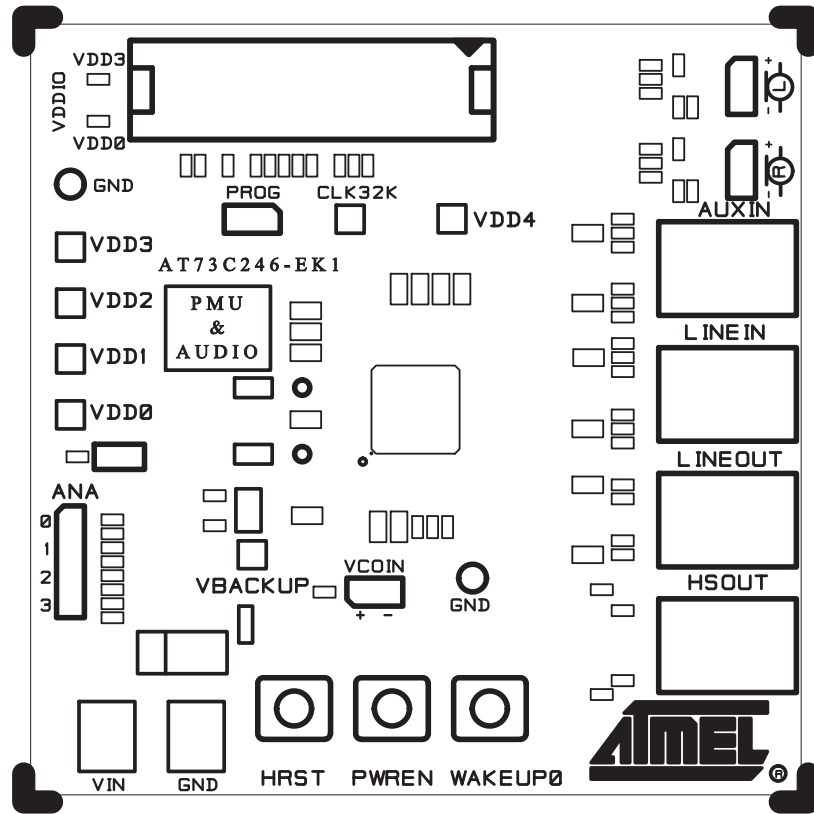
**Note:** Size not to scale

**Figure 6-4.** Layer 4 - Print Side



**Note:** Size not to scale

Figure 6-5. Silk Screen







# Section 7 Schematics

**Figure 7-1.** AT73C246-EK1 Schematic - Main Page

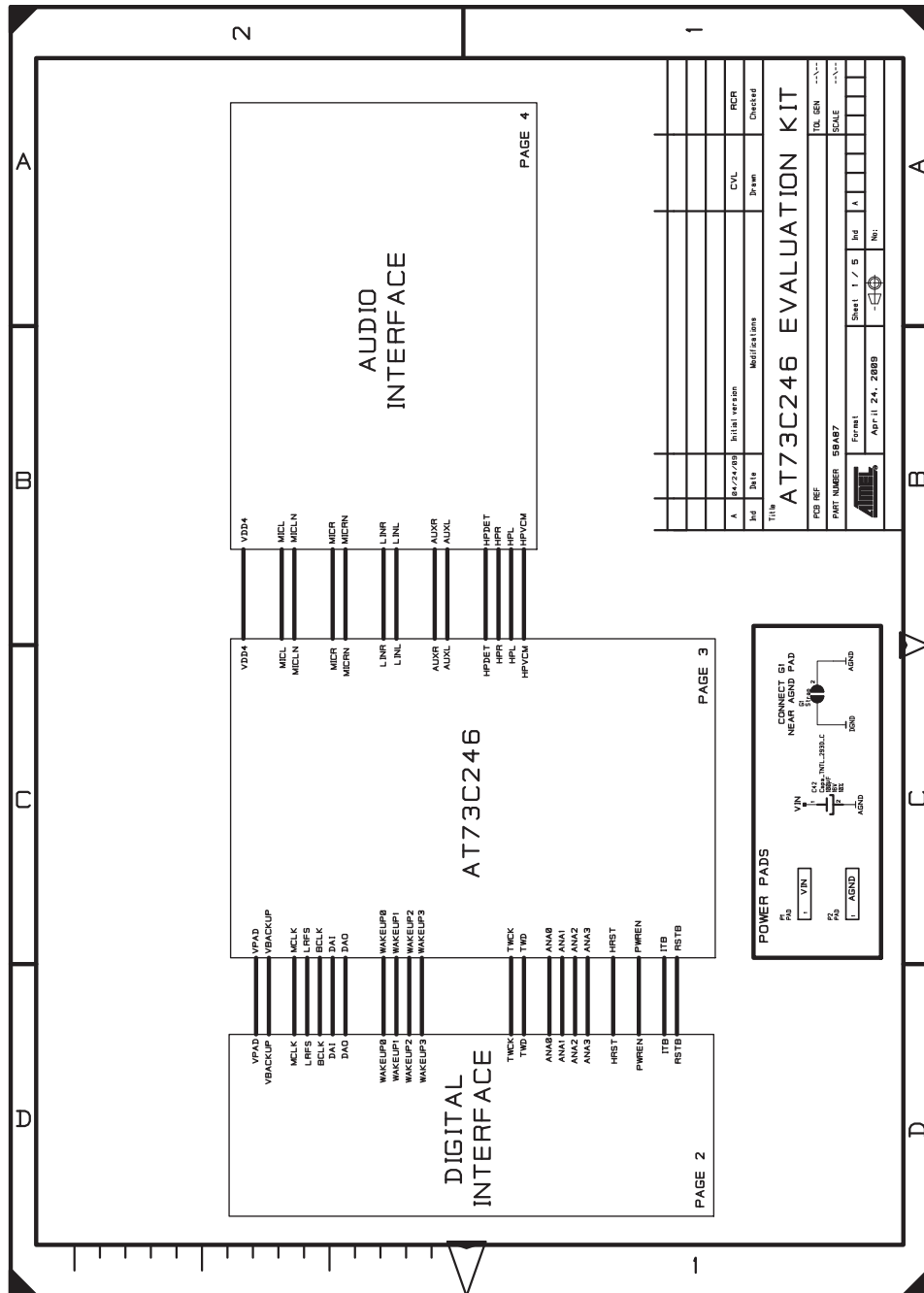


Figure 7-2. AT73C246-EK1 Schematic - AT73C246 Page

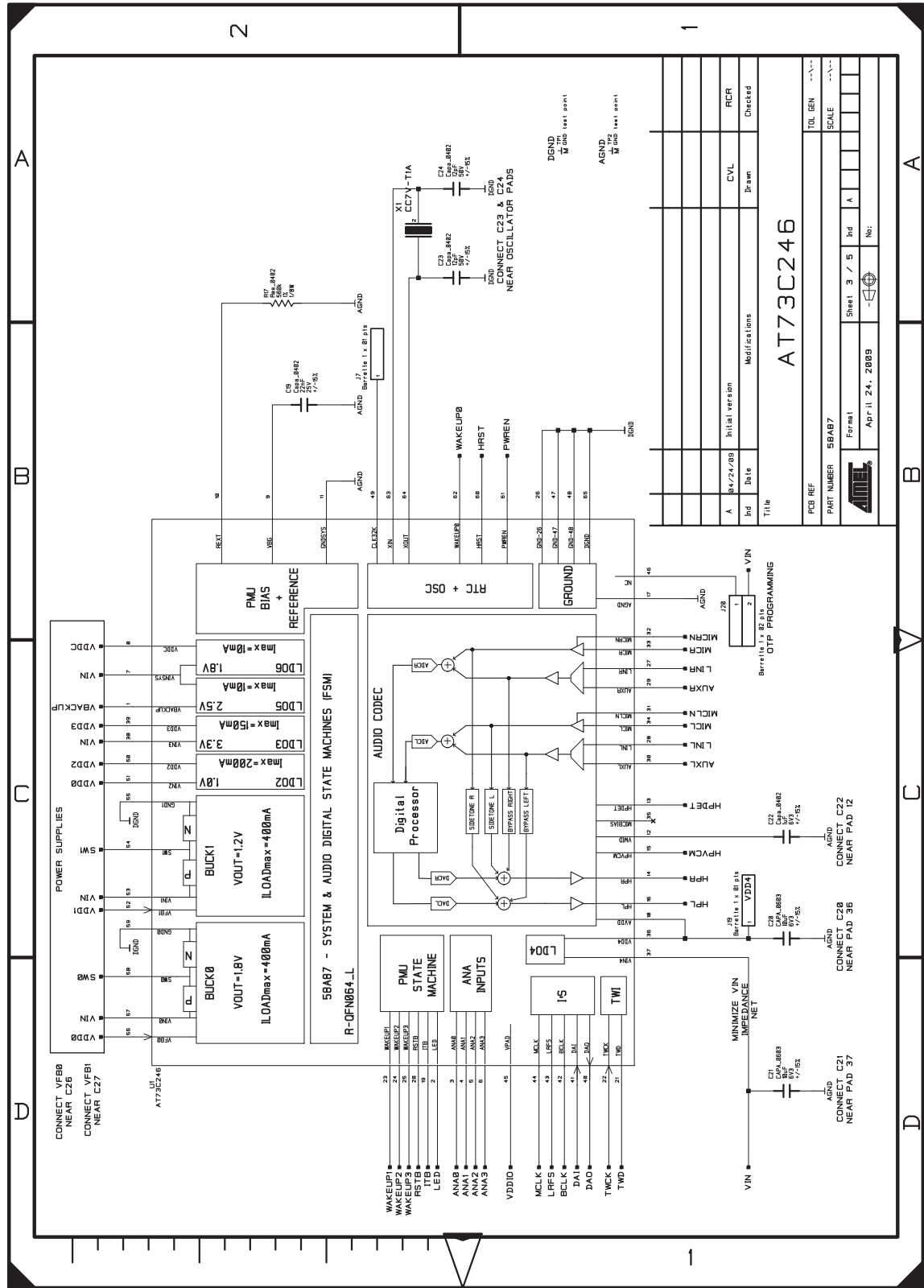




Figure 7-3. AT73C246-EK1 Schematic - Audio Interface Page

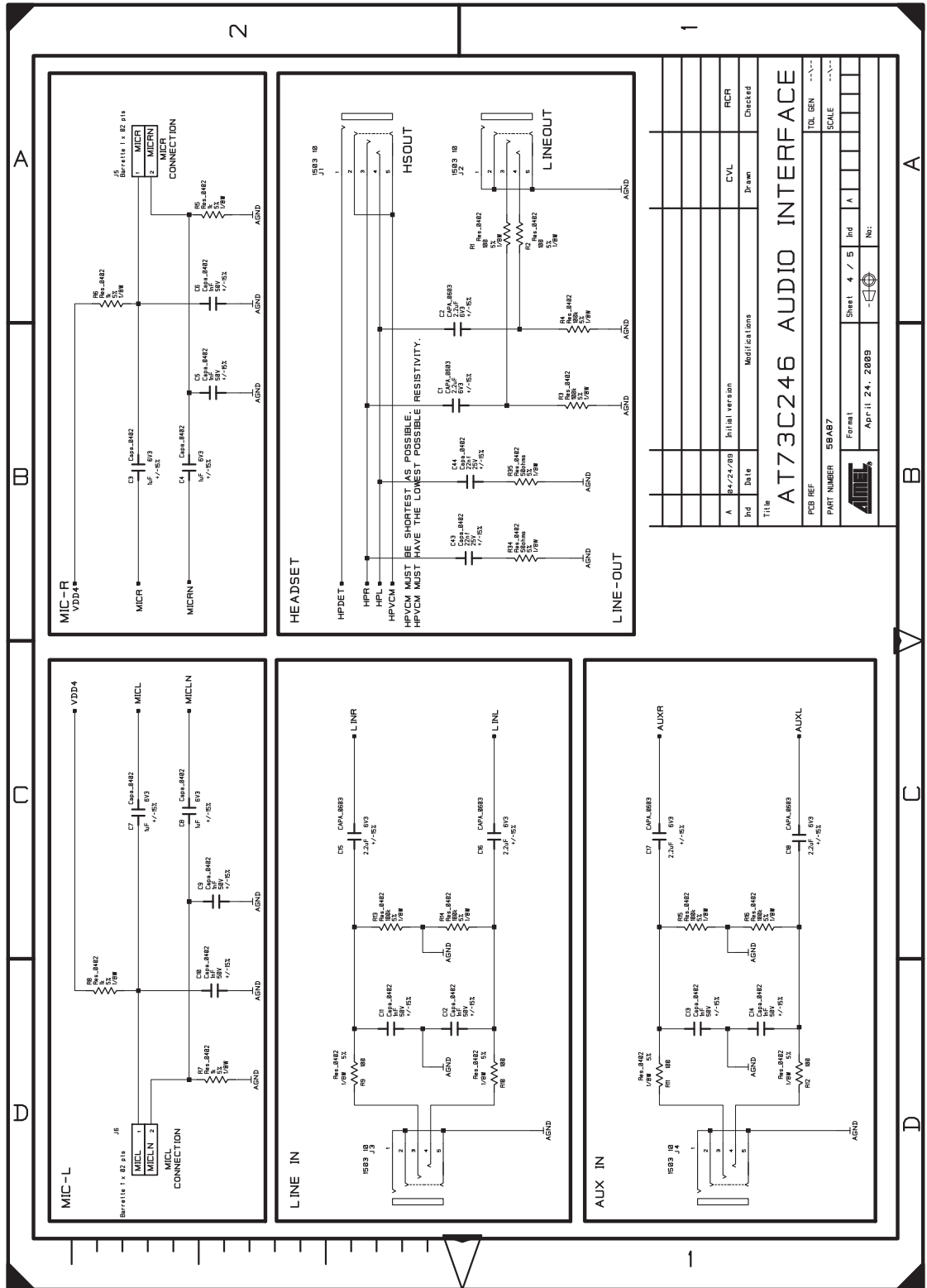


Figure 7-4. AT73C246-EK1 Schematic - Digital Interface Page

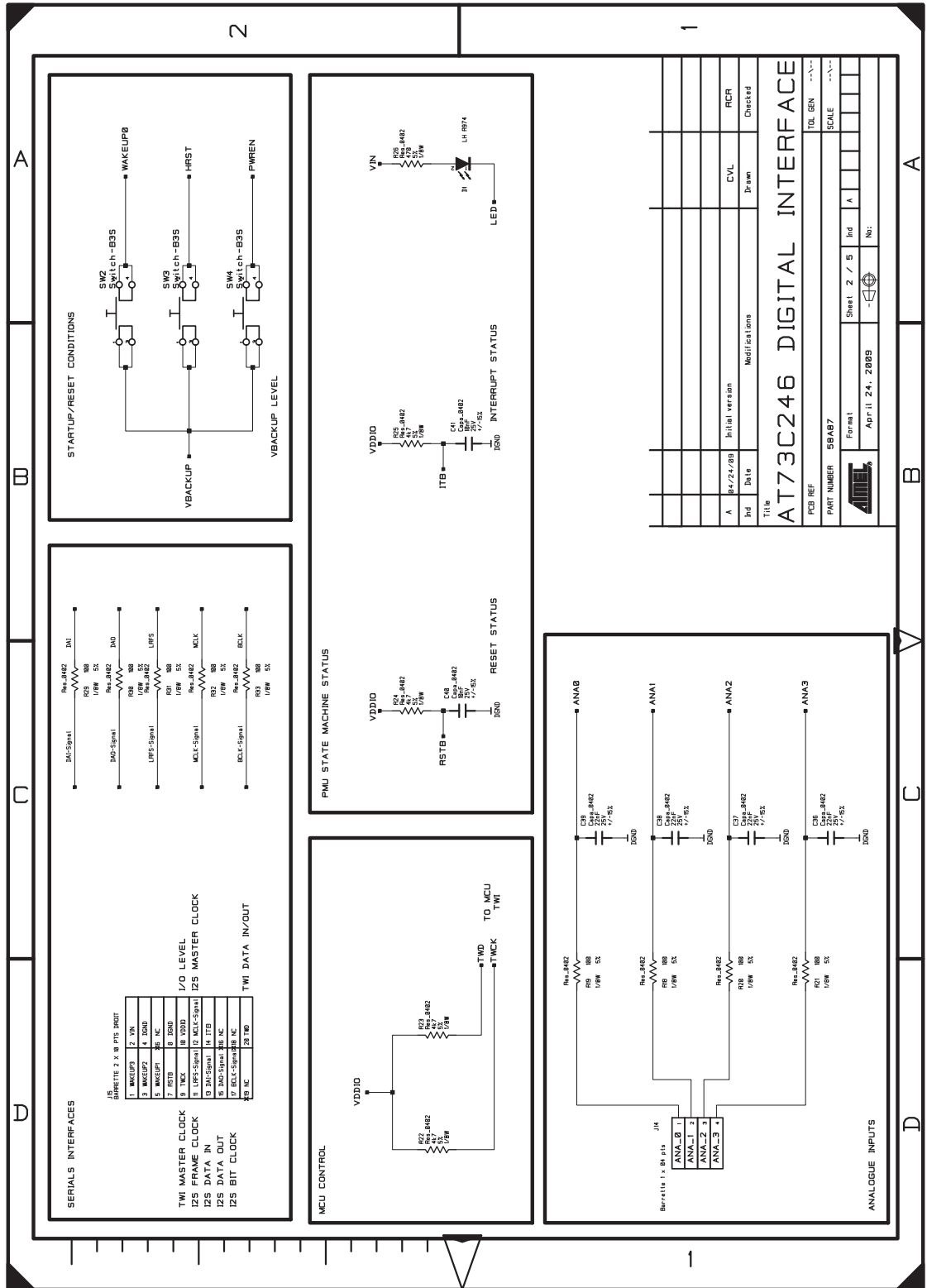
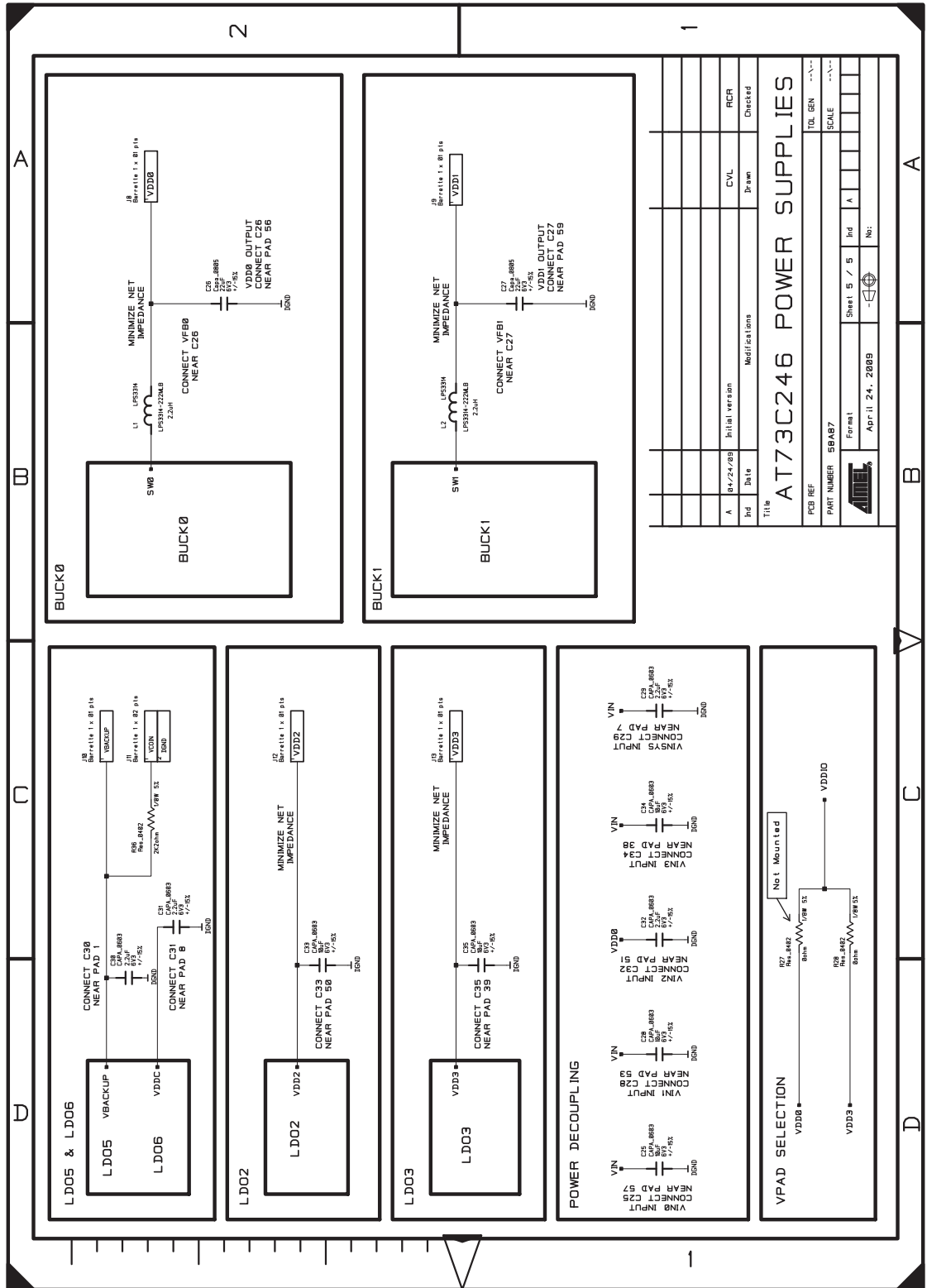


Figure 7-5. AT73C246-EK1 Schematic - Power Supply Page







## Section 8

# Revision History

### 8.1 Revision History

*Table 8-1.* Revision History

Doc. Rev	Date	Comments	Change Request Ref.
11047A	08-Apr-10		





## Headquarters

---

**Atmel Corporation**  
2325 Orchard Parkway  
San Jose, CA 95131  
USA  
Tel: 1(408) 441-0311  
Fax: 1(408) 487-2600

## International

---

**Atmel Asia**  
Unit 1-5 & 16, 19/F  
BEA Tower, Millennium City 5  
418 Kwun Tong Road  
Kwun Tong, Kowloon  
Hong Kong  
Tel: (852) 2245-6100  
Fax: (852) 2722-1369

**Atmel Europe**  
Le Krebs  
8, Rue Jean-Pierre Timbaud  
BP 309  
78054 Saint-Quentin-en-  
Yvelines Cedex  
France  
Tel: (33) 1-30-60-70-00  
Fax: (33) 1-30-60-71-11

**Atmel Japan**  
9F, Tonetsu Shinkawa Bldg.  
1-24-8 Shinkawa  
Chuo-ku, Tokyo 104-0033  
Japan  
Tel: (81) 3-3523-3551  
Fax: (81) 3-3523-7581

## Product Contact

---

**Web Site**  
[www.atmel.com](http://www.atmel.com)  
[www.atmel.com/products/power-manage/default.asp](http://www.atmel.com/products/power-manage/default.asp)

**Technical Support**  
[Atmel technical support](http://Atmel technical support)

**Sales Contacts**  
[www.atmel.com/contacts/](http://www.atmel.com/contacts/)

**Literature Requests**  
[www.atmel.com/literature](http://www.atmel.com/literature)

---

**Disclaimer:** The information in this document is provided in connection with Atmel products. No license, express or implied, by estoppel or otherwise, to any intellectual property right is granted by this document or in connection with the sale of Atmel products. **EXCEPT AS SET FORTH IN ATMEL'S TERMS AND CONDITIONS OF SALE LOCATED ON ATMEL'S WEB SITE, ATMEL ASSUMES NO LIABILITY WHATSOEVER AND DISCLAIMS ANY EXPRESS, IMPLIED OR STATUTORY WARRANTY RELATING TO ITS PRODUCTS INCLUDING, BUT NOT LIMITED TO, THE IMPLIED WARRANTY OF MERCHANTABILITY, FITNESS FOR A PARTICULAR PURPOSE, OR NON-INFRINGEMENT. IN NO EVENT SHALL ATMEL BE LIABLE FOR ANY DIRECT, INDIRECT, CONSEQUENTIAL, PUNITIVE, SPECIAL OR INCIDENTAL DAMAGES (INCLUDING, WITHOUT LIMITATION, DAMAGES FOR LOSS OF PROFITS, BUSINESS INTERRUPTION, OR LOSS OF INFORMATION) ARISING OUT OF THE USE OR INABILITY TO USE THIS DOCUMENT, EVEN IF ATMEL HAS BEEN ADVISED OF THE POSSIBILITY OF SUCH DAMAGES.** Atmel makes no representations or warranties with respect to the accuracy or completeness of the contents of this document and reserves the right to make changes to specifications and product descriptions at any time without notice. Atmel does not make any commitment to update the information contained herein. Unless specifically provided otherwise, Atmel products are not suitable for, and shall not be used in, automotive applications. Atmel's products are not intended, authorized, or warranted for use as components in applications intended to support or sustain life.

© 2010 Atmel Corporation. All rights reserved. Atmel®, logo and combinations thereof, and others are registered trademarks or trademarks of Atmel Corporation or its subsidiaries. Other terms and product names may be trademarks of others.

