

# HGN-365A IEC 60320 INLET SOCKET WITH SINGLE OR DOUBLE FUSE HOLDER, SNAP-IN OR FLANGE MOUNT



## FEATURES

The HGN-365A filter series offers a wide variety of options with a current rating up to 10A, 250VAC. This power entry module offers industry standard 5 x 20mm fuse/s with IEC connector. This series offers an option of having a single or double fuse in the same package. These filters are also used for health care equipment and offer extremely low leakage current to comply with UL544 & 2602.

A Ground Choke can be added to enhance the grounding ability of the circuit. A bleeder resistor can also be added to prevent excessive voltages from developing across the filter capacitors when there is no load.

## APPLICATIONS

Computer & networking equipment, Measuring & control equipment, Data processing equipment, laboratory instruments, Switching power supplies, other electronic equipment.

## TECHNICAL DATA

- Rated Voltage: 115/250VAC
- Rated Current: 1A, 2A, 3A, 4A, 6A, 8A, 10A
- Power Line Frequency: 50/60Hz
- Max. Leakage Current each  
Line to Ground:
  - @ 115VAC 60Hz: 0.5mA
  - @ 250VAC 50Hz: 1.0mA
  - @ 115VAC 60Hz: 2 $\mu$ A\*
  - @ 250VAC 50Hz: 5 $\mu$ A\*
- Hipot Rating (one minute)
  - Line to Ground: 2250VDC
  - Line to Line: 1450VDC
- Temperature Range: -25C to +85C

\* Medical application

Panel Thickness 1mm to 1.6mm

## MECHANICAL DIMENSIONS (Unit: mm)

### SNAP-IN

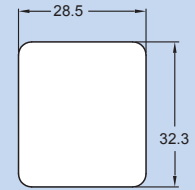
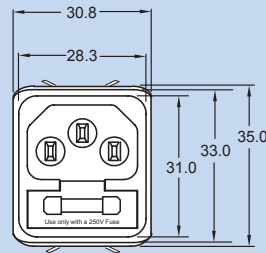

SUGGESTED PANEL CUTOUT  
(MOUNTING FROM FRONT)  
THICKNESS OF PANEL IS FROM  
1.00mm to 1.6mm

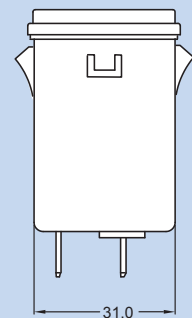
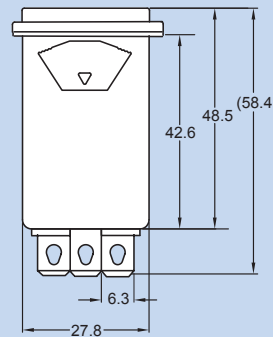

## FLANGE MOUNT

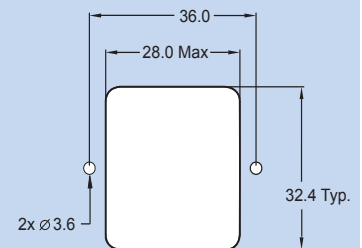
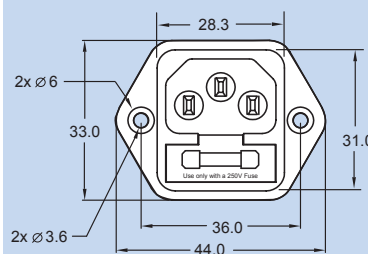

RECOMMENDED  
PANEL CUTOUT  
(MOUNTING FROM FRONT)

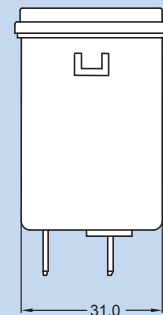
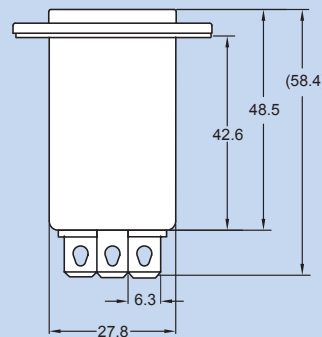

Specifications subject to change without notice. Dimensions (mm). See Appendix A for recommended power cord. See PDI full line catalog for detailed specifications on power cords.

# HGN-365A Series Example & Ordering Code

## HGN-365A

01 Q - 1 5 - 1 A S

CURRENT RATING (A):

= 01
= 02
= 03
= 04
= 06
= 08
= 10

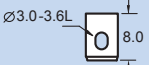
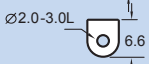
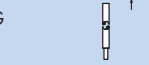

TERMINAL:

6.3/0.25		QUICK CONNECT = Q
4.0/0.187		SOLDER = S
UL 1015, 18AWG STRANDED, 4"		WIRE = W

FUSE OPTION:

1 FUSE (5X20MM) = 1
2 FUSE (5X20MM) = 2 <sup>†</sup>

OPTIONS:

NO BLEEDER RESISTOR & NO GROUND CHOKE = 0
BLEEDER RESISTOR (1/4 W, 1M) = 5
BLEEDER RESISTOR (1/2 W, 1M) = 6
BLEEDER RESISTOR (1/4 W, 1M) & GROUND CHOKE = 7
BLEEDER RESISTOR (1/2 W, 1M) & GROUND CHOKE = 8
GROUND CHOKE (100µH) = 9

COMPONENT LOCATIONS:

STANDARD TYPE = 1
WITH C(X) & C(Y) BEHIND L = 2 <sup>+</sup>
WITHOUT C(X); C(Y) ONLY = 3 <sup>+</sup>
WITHOUT C(Y); C(X) ONLY = 1M
WITHOUT C(Y); C(X) BEHIND L = 2M <sup>+</sup>

ATTENUATION CODE TABLE:

**Non-Medical applications**, select Attenuation code with corresponding component values from the table.

Cap C(x)	Cap C(y)	1A (mH)	2A (mH)	3A (mH)	4A (mH)	6A (mH)	8A (mH)	10A (mH)	
0.1µF	2200pF	6.5	3.8	2.5	1.6	0.8	1.05	0.2	= A
0.015µF	3300pF	1.9	1.5	1.1	0.8	0.6	*	0.3	= B
0.1µF	3300pF	3.7	2.7	1.8	1.3	0.8	1.05	0.3	= C
0.1µF	1000pF	10.5	4.2	2.5	1.7	1.05	*	0.3	= D
0.047µF	3300pF	4.6	3.4	2.5	1.4	0.9	*	0.3	= E
0.033µF	3300pF	9.5	4.3	1.8	1.2	0.85	*	0.3	= F
0.22µF	2200pF	6.5	4.0	2.5	2.0	0.85	1.05	0.3	= G
0.22µF	3300pF	6.5	4.0	2.5	2.0	0.85	1.05	0.3	= H
0.047µF	2200pF	10.5	4.0	1.2	0.9	0.53	*	0.3	= I
0.033µF	2200pF	5	3.7	1.8	1.1	0.6	*	0.2	= J
*	*	10.5	6.5	2.5	2.7	1.05	*	0.3	= K

**Medical applications**, select Attenuation code with corresponding component values from the table.

Cap C(x)	1A (mH)	2A (mH)	3A (mH)	4A (mH)	6A (mH)	8A (mH)	10A (mH)	
0.1µF	6.5	3.8	2.5	1.6	0.8	1.05	0.2	= M1
0.015µF	1.9	1.5	1.1	0.8	0.6	*	0.3	= M2
0.1µF	3.7	2.7	1.8	1.3	*	*	0.3	= M3
0.1µF	*	4.2	*	1.7	*	*	*	= M4
0.047µF	4.6	3.4	2.5	1.4	0.9	*	0.3	= M5
0.033µF	9.5	4.3	1.8	1.2	0.85	*	0.3	= M6
0.22µF	6.5	4.0	2.5	2.0	0.8	1.05	0.3	= M7
0.047µF	10.5	4.0	1.2	0.9	0.53	*	*	= M8
0.033µF	5.0	3.7	*	1.1	0.6	*	0.2	= M9

TYPE OF MOUNTING:

FLANGE MOUNT = BLANK
SNAP-IN TABS - TOP BOTTOM = T
SNAP-IN TABS - SIDE = S

## SCHEMATICS

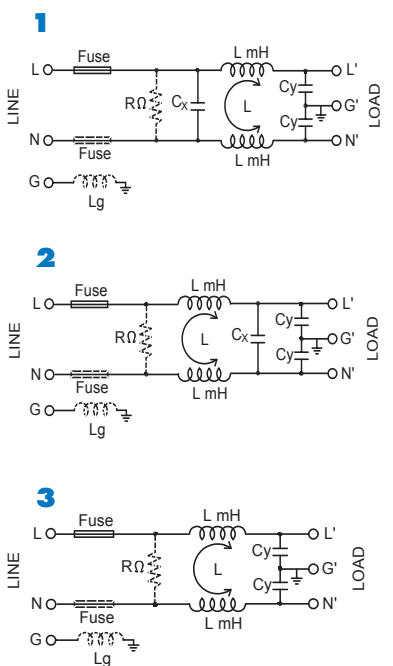

## MEDICAL SCHEMATICS

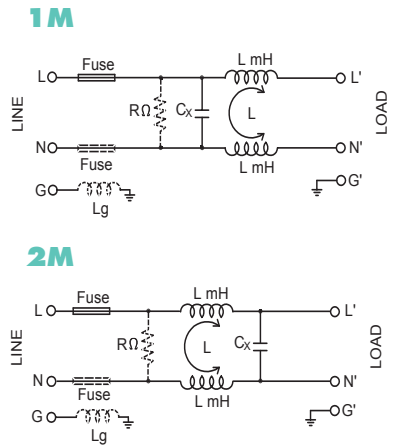

\*Contact PDI for attenuation numbers  
<sup>†</sup>Flange mount only  
 \*Contact PDI for availability

# HGN-365A Series Example & Ordering Code

## Non-Medical Applications\*

Insertion loss in dB (50 Ohm circuit)

## Medical Applications\*

Insertion loss in dB (50 Ohm circuit)

Attenuation Code	Current Rating	Comm. Mode(L-G) in MHz					Diff. mode(L-L) in MHz						
		.15	.5	1	5	10 30	.15	.5	1	5	10 30		
A	1A	34	38	40	32	26	11	8	25	37	71	62	12
	2A	29	32	55	48	49	51	8	23	34	68	64	14
	3A	28	36	39	45	48	39	8	19	27	58	65	15
	4A	22	27	30	48	54	47	8	19	28	66	72	34
	6A	18	24	28	44	50	47	8	18	26	43	51	31
	8A	20	26	30	44	47	40	8	18	24	65	59	22
	10A	8	14	18	33	41	39	8	18	25	29	38	31
B	1A	25	31	33	30	25	14	1	4	12	50	64	16
	2A	24	28	20	53	54	55	1	4	13	53	57	16
	3A	19	22	24	27	27	22	1	3	8	48	59	31
	4A	23	27	32	54	49	42	1	4	8	40	52	25
	6A	15	24	30	44	52	40	1	4	8	36	52	28
	8A	11	18	23	39	49	37	1	4	8	26	46	24
	10A	11	18	23	39	49	37	1	4	8	26	46	24
C	1A	29	33	47	53	57	41	8	23	35	73	58	14
	2A	28	37	44	52	56	41	8	19	27	74	59	17
	3A	25	33	46	53	57	44	8	19	29	63	62	13
	4A	19	24	27	43	53	38	8	18	25	57	60	32
	6A	19	29	36	49	55	46	8	18	23	50	54	24
	8A	20	24	26	27	25	15	8	18	24	58	57	21
	10A	11	19	24	41	53	36	8	18	24	51	46	25
D	1A	36	41	41	49	49	46	8	23	33	62	62	32
	2A	36	41	41	49	49	46	8	23	33	62	62	32
	3A	28	35	37	41	42	42	8	19	28	56	57	17
	4A	19	23	24	40	45	42	8	18	26	50	55	33
	6A	21	28	31	41	44	41	8	18	25	45	48	29
	8A	12	16	19	45	37	41	8	18	24	52	53	30
	10A	12	16	19	45	37	41	8	18	24	52	53	30
E	1A	32	39	55	55	56	52	3	14	25	75	63	24
	2A	29	34	46	56	58	49	3	15	27	67	59	21
	3A	28	38	44	51	58	39	3	12	20	66	57	18
	4A	20	26	30	51	59	47	3	11	18	49	54	29
	6A	18	25	31	49	56	47	3	11	17	55	59	32
	8A	11	19	24	40	50	40	3	12	17	48	46	29
	10A	11	19	24	40	50	40	3	12	17	48	46	29
F	1A	40	32	44	52	55	38	2	18	30	66	56	22
	2A	32	39	56	56	58	58	1	10	21	76	62	23
	3A	23	29	35	53	52	40	1	9	17	66	65	33
	4A	20	25	29	50	60	45	1	8	15	53	60	32
	6A	19	29	35	51	54	49	2	8	13	47	57	28
	8A	11	19	25	40	51	39	2	9	14	46	51	29
	10A	11	19	25	40	51	39	2	9	14	46	51	29
G	1A	37	43	52	47	46	45	17	35	47	65	58	34
	2A	36	25	30	54	51	45	16	31	41	51	61	15
	3A	28	36	39	46	49	52	15	26	36	58	63	17
	4A	24	29	33	45	45	50	15	27	36	59	62	23
	6A	18	24	28	42	48	39	15	26	33	48	58	26
	8A	20	26	30	45	48	38	15	26	34	45	55	20
	10A	10	20	25	38	44	38	15	26	33	33	44	28
H	1A	37	19	53	51	51	41	17	35	47	68	57	34
	2A	38	23	33	57	55	48	15	31	42	59	64	15
	3A	28	37	45	48	50	55	15	26	35	64	62	16
	4A	25	30	39	47	49	41	15	26	36	61	53	20
	6A	18	25	31	45	51	40	15	26	33	51	57	27
	8A	20	28	34	51	53	41	15	26	33	50	58	21
	10A	10	19	23	35	42	35	15	26	33	36	46	29
I	1A	38	42	42	25	25	20	4	22	34	59	65	21
	2A	32	39	56	56	58	58	1	10	21	76	62	23
	3A	20	25	28	44	49	42	3	12	19	61	57	27
	4A	18	23	28	44	49	42	3	11	17	50	62	30
	6A	14	19	22	39	48	41	3	11	17	48	50	33
	8A	11	17	22	36	42	38	3	11	17	39	55	27
	10A	11	17	22	36	42	38	3	11	17	39	55	27
J	1A	32	34	52	44	44	41	1	14	25	60	66	21
	2A	29	32	56	49	50	45	1	12	24	67	62	14
	3A	23	27	30	49	52	46	1	9	17	59	69	30
	4A	19	23	27	44	51	42	1	8	15	67	58	33
	6A	16	20	24	42	51	42	1	8	14	58	52	33
	8A	11	17	22	36	41	40	2	8	14	37	54	27
	10A	11	17	22	36	41	40	2	8	14	37	54	27
K	1A	36	42	43	37	31	36	1	2	5	17	23	33
	2A	30	37	39	29	22	27	1	1	3	14	21	13
	3A	28	35	37	28	22	31	1	1	2	11	18	12
	4A	28	35	37	28	22	26	1	1	1	11	17	10
	6A	21	29	32	31	27	17	1	1	1	7	12	23
	8A	11	16	18	18	17	14	1	1	1	5	13	9
	10A	11	16	18	18	17	14	1	1	1	5	13	9

Attenuation Code	Current Rating	Comm. Mode(L-G) in MHz					Diff. mode(L-L) in MHz						
		.15	.5	1	5	10 30	.15	.5	1	5	10 30		
M1	1A	34	38	39	32	16	21	9	26	37	62	51	11
	2A	29	32	34	30	19	16	8	23	34	60	48	13
	3A	28	35	37	28	22	19	8	19	28	52	44	12
	4A	22	26	27	30	30	28	8	20	29	57	52	33
	6A	18	22	24	27	25	18	8	18	26	52	45	27
	8A	20	24	26	27	25	14	8	18	26	43	40	17
	10A	8	13	15	17	16	14	8	18	25	32	28	24
M2	1A	25	31	33	30	24	21	1	5	14	41	46	17
	2A	23	27	28	29	24	23	1	5	14	45	58	15
	3A	19	22	24	27	27	20	1	4	10	39	50	34
	4A	19	26	29	28	25	15	1	4	9	32	42	25
	6A	15	21	24	23	21	17	1	4	9	30	49	28
	8A	11	16	18	17	16	12	1	4	8	26	45	24
	10A	11	16	18	17	16	12	1	4	8	26	45	24
M3	1A	29	33	34	30	20	16	8	24	35	58	45	15
	2A	28	35	37	28	22	24	8	20	29	61	48	15
	3A	25	33	58	51	56	41	8	20	30	57	47	13
	4A	19	23	24	27	27	21	8	19	27	47	45	30
	6A	11	16	18	18	16	12	8	18	24	47	36	24
	8A	11	16	18	18	16	12	8	18	24	47	36	24
	10A	11	16	18	18	16	12	8	18	24	47	36	24
M4	2A	31	37	39	35	29	22	8	22	32	66	55	22
	4A	19	23	24	27	27	22	8	19	27	50	47	30
	1A	32	37	40	35	29	23	3	15	25	74	58	21
	2A	29	33	34	30	16	21	3	16	27	57	50	20
	3A	28	35	37	28	22	23	3	13	22	59	48	16
	4A	20	24	25	28	28	21	3	12	20	43	44	27
	6A	18	23	25	27	26	20	3	12	19	48	49	30
10A	11	16	18	18	17	14	3	11	17	42	38	27	
M6	1A	37	41	41	25	41	17	2	19	31	62	46	21
	2A	32	37	40	36	30	22	1	11	22	63	59	24
	3A	23	27	28	31	30	30	1	10	19	61	52	32
	4A	19	23	24	27	27	20	1	9	17	44	47	31
	6A	19	26	29	29	25	17	1	8	15	39	45	25
	8A	11	16	18	18	17	14	2	8	14	42	34	25
	10A	11	16	18	18	17	14	2	8	14	42	34	25
M7	1A	37	44	41	23	31	18	17	35	47	54	42	32
	2A	32	42	42	32	20	17	16	31	42	53	47	14
	3A	28	34	36	29	23	22	15	27	37	52	49	13
	4A	24	28	29	26	19	10	15	27	38	52	45	19
	6A	15	22	24	25	23	19	15	26	35	43	41	23
	8A	20	24	26	27	25	13	15	26	36	38	37	18
	10A	10	18	20	20	18	13	15	26	34	34	31	23
M8	1A	38	42	42	25	44	17	4	22	33	52	42	20
	2A	31	37	40	36	29	25	3	15	25	80	60	25
	3A	20											