



## MIC23156 Evaluation Board

### 1.5A, 3MHz Synchronous Buck Regulator with HyperLight Load<sup>®</sup> and I<sup>2</sup>C Control for Dynamic Voltage Scaling

## General Description

The MIC23156 evaluation board allows the customer to evaluate a fully-integrated 1.5A, 3MHz synchronous buck regulator that features HyperLight Load<sup>®</sup> mode, a power good (PGOOD) output indicator, a programmable soft-start, and an output voltage scaling control through I<sup>2</sup>C. The MIC23156 is highly efficient throughout the output current range, drawing just 30 $\mu$ A of quiescent current during operation. The ability to dynamically change the output voltage in 10mV steps through I<sup>2</sup>C and maintain high output voltage accuracy makes the MIC23156 simple to use and versatile. The MIC23156 is available in both 16-ball, 0.4mm pitch, 1.81mm  $\times$  1.71mm wafer level chip scale (WLCSP), and 17-pin 2.8mm  $\times$  2.5mm MLF<sup>®</sup> packages.

## Requirements

The MIC23156 evaluation board requires a single 10W power source adjustable from 2.7V to 5.5V. The loads can either be active (electronic load) or passive (resistor), and must be able to dissipate 5W. It is ideal, but not essential, to have an oscilloscope available to view the circuit waveforms. The simplest tests require two voltage meters to measure input and output voltages. Efficiency measurements require two voltage meters and two ammeters to prevent errors caused by measurement inaccuracies.

To use the dynamic voltage scaling feature, an I<sup>2</sup>C serial programmer board (MICUSB I<sup>2</sup>C Dongle EV), software package/kit (available for download online), and a computer are necessary.

## Precautions

There is no reverse input protection on this board. Be careful when connecting the input source to ensure correct polarity is observed.

Datasheets and support documentation are available on Micrel's web site at: [www.micrel.com](http://www.micrel.com).

## Getting Started

### 1. Connect an external supply to the V<sub>IN</sub> (J1) and GND (J2) terminals.

With the output of the power supply disabled, set its voltage to the desired input test voltage ( $2.7V \leq V_{IN} \leq 5.5V$ ). An ammeter may be placed between the input supply and the V<sub>IN</sub> (J1) terminal. Be sure to monitor the supply voltage at the V<sub>IN</sub> (J1) terminal, as the ammeter and/or power lead resistance can reduce the voltage supplied to the device.

### 2. Jumper VSEL via TP1.

Pulling VSEL high to V<sub>CC</sub> in MLF or V<sup>I</sup>2C in YCS sets the default output voltage to 0.8V. Setting VSEL low to GND sets the default output voltage to 1.0V.

### 3. Connect a load to the V<sub>OUT</sub> (J6 in YML and J3 in YCS) and GND (J7 in YML and J4 in YCS) terminals.

The load can be either passive (resistive) or active (electronic load). An ammeter may be placed between the load and the output terminal. Make sure the output voltage is monitored at the V<sub>OUT</sub> terminal. The board is also equipped with a 2-pin connector (JP2) to allow for output voltage monitoring.

### 4. Enable the MIC23156 via TP2.

To enable the MIC23156, jumper TP2 to V<sub>CC</sub> in YML or V<sub>IN</sub> in YCS. To disable the device, jumper TP2 to GND. An alternative method of enabling and disabling the EN pin is by applying a second power source to the EN and GND terminals. Do not leave this pin floating.

## Ordering Information

Part Number	Description
MIC23156-0YML EV <sup>(1)</sup>	1.5A synchronous buck regulator with I <sup>2</sup> C in a 17-pin 2.8mm $\times$ 2.5mm MLF.
MIC23156-0YCS EV	1.5A synchronous buck regulator with I <sup>2</sup> C in a 16-ball 1.81mm $\times$ 1.71mm WLCSP.
MICUSB Dongle	I <sup>2</sup> C serial programmer board.

### Note:

1. Contact Micrel Marketing for availability.

HyperLight Load is a registered trademark of Micrel, Inc.

MLF and MicroLeadFrame are registered trademarks of Amkor Technology, Inc.

Micrel Inc. • 2180 Fortune Drive • San Jose, CA 95131 • USA • tel +1 (408) 944-0800 • fax +1 (408) 474-1000 • <http://www.micrel.com>

**5. Power Good (J3 in YML).**

A power good (PGOOD) test point is provided to monitor the PGOOD function (available only on the YML evaluation board). Connect a voltage meter or an oscilloscope to the PGOOD pin.

**6. Connect the I<sup>2</sup>C serial programmer board (MICUSB I<sup>2</sup>C Dongle evaluation board) to JP1 of the MIC23156 evaluation board.**

Make sure the switch on the I<sup>2</sup>C serial programmer board is switched to "I2C" and not "NOM".

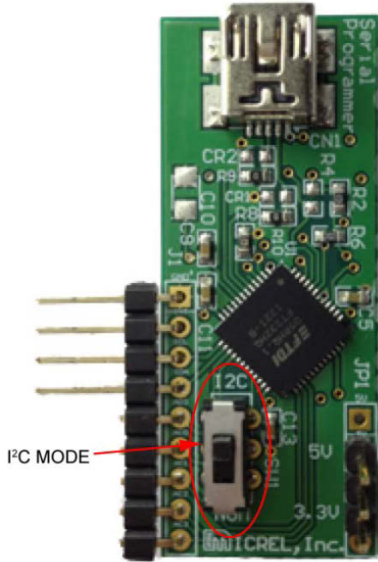

Plug the 9-pin connector of the I<sup>2</sup>C board to JP1 of the MIC23156 evaluation board. Take extra care when connecting the two boards together and make sure the GND pins are matched (GND of I<sup>2</sup>C board connects to GND of MIC23156). Then connect the I<sup>2</sup>C serial programmer board to a laptop or desktop using a USB to Mini-B USB type cable.

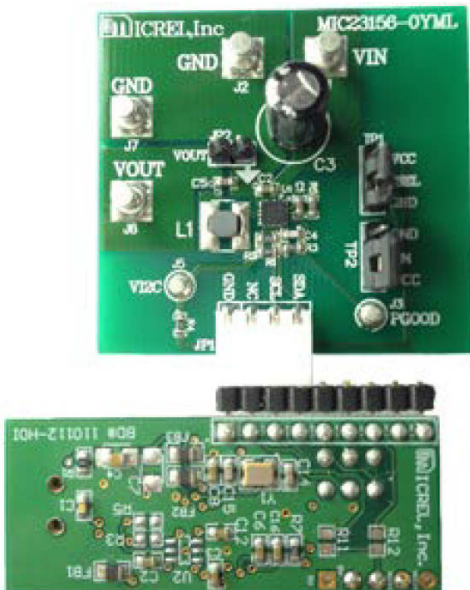

**7. Open and control the MIC23156 via the I<sup>2</sup>C serial programmer interface**

Download the software package/kit found on the [MIC23156 product page](#) on Micrel's website. Open the I<sup>2</sup>C interface and follow the steps below:

- a. Open the I<sup>2</sup>C serial programmer interface and click **Test**. The status bar at the bottom of the window should change from **value** to **Target OK**.

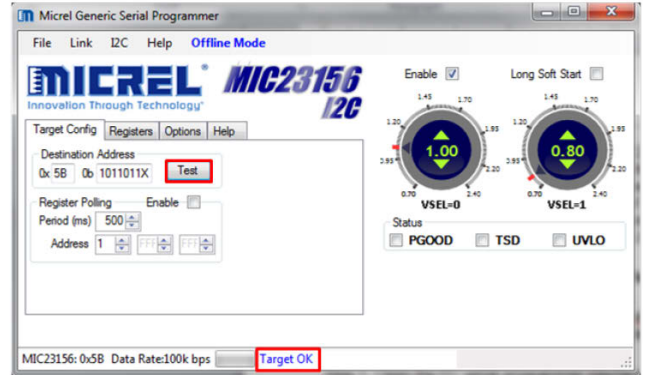

- b. Click the **Registers** tab and then click **Read**. The **PGOOD** status box will automatically be checked if the output voltage regulation is above the PGOOD fault threshold. If the **UVLO** box is checked, it means the input voltage is too low. If the **TSD** box is checked, it means the internal die temperature is too high and the device is now in thermal shutdown to prevent damage.

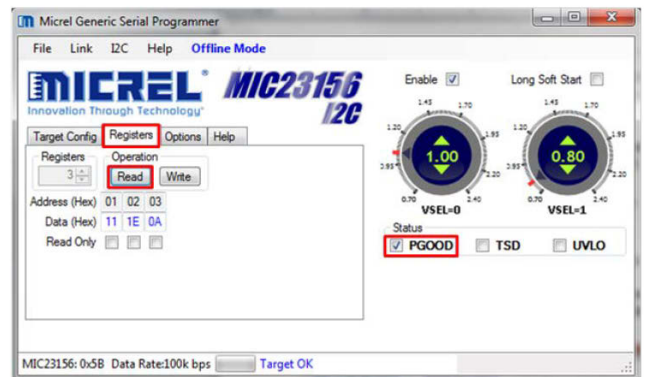

- c. Click **Offline Mode** once and it will toggle to **Direct Editing Mode**. In direct editing mode, any modifications made in the I<sup>2</sup>C interface, such as enabling/disabling the device, setting a long soft start, or changing the output voltage, will be recognized instantaneously at the VOUT terminal of the MIC23156 evaluation board.

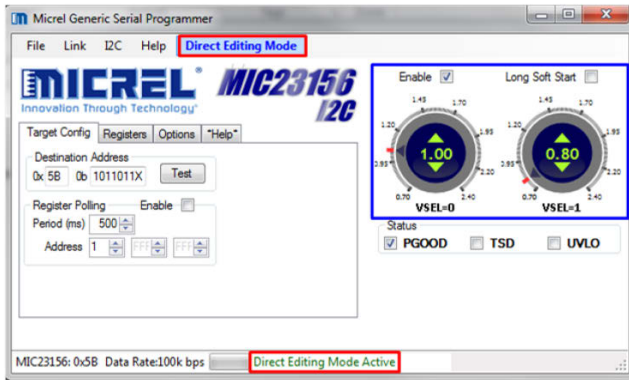

**Note:** As soon as the input supply or enable pin on the MIC23156 evaluation board is powered down and up, the output voltage automatically returns to its default values. In the case of MIC23156-0YML and MIC23156-0YCS, the default output voltages are 0.8V (VSEL is high) and 1.0V (VSEL is low).

## Evaluation Board

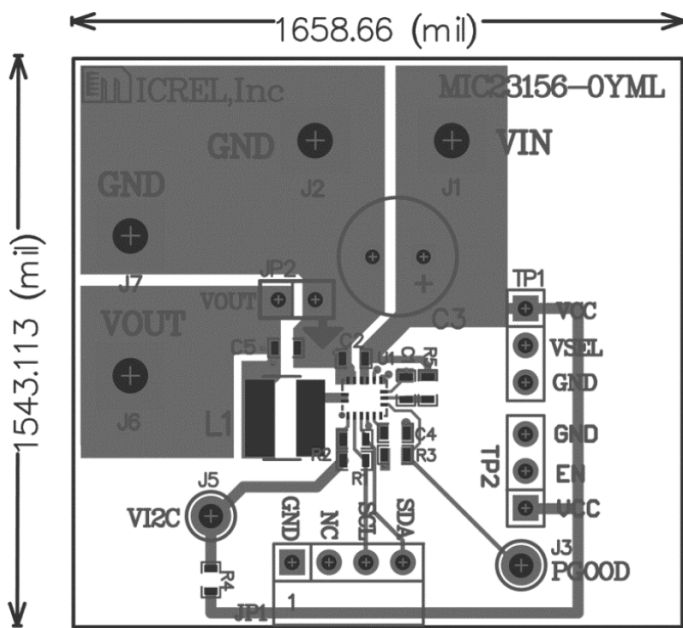

## Features

### Soft-Start Capacitor (C4)

The MIC23156 has a nominal 820kΩ resistor charging the capacitor on the SS pin. This enables the output to follow a controlled soft-start characteristic. Setting C4 to 120pF sets the startup time to approximately 230μs. The start-up time can be determined by Equation 1:

$$T_{SS} = 820 \times 10^3 \times \ln(10) \times C_{SS} \quad \text{Eq. 1}$$

The action of the soft-start capacitor is to control the rise time of the internal reference voltage between 0% and 100% of its nominal steady state value.

### Power Good (PGOOD)

The YML evaluation board has a test point provided for monitoring the power good (PGOOD) feature. This is an open-drain connection with an on-board pull-up resistor of 100kΩ to the output voltage. PGOOD is asserted high approximately 70μs after the output voltage passes 90% of the nominal set voltage.

The PGOOD signal will remain high as long as  $V_{OUT}$  regulates within 14% of its nominal output voltage. When  $V_{OUT}$  regulation drops below the threshold, the PGOOD signal will trip a fault condition and assert low.

### VSEL

Selectable output voltage is a good feature to have in a power saving system design.

The MIC23156 has the ability to switch from a high output to a low output voltage and vice versa in a matter of hundreds of microseconds. The default output voltage setting for  $V_{SEL} \leq (0.3 \times V_{I^2C})$  is 1.0V, and 0.8V for  $V_{SEL} \geq (0.7 \times V_{I^2C})$ . The programmable output voltage ranges from 0.7V to 2.4V and can be easily changed via I<sup>2</sup>C programming.

### HyperLight Load Mode

MIC23156 uses a minimum on and off time proprietary control loop (patented by Micrel). When the output voltage falls below the regulation threshold, the error comparator begins a switching cycle that turns the PMOS on and keeps it on for the duration of the minimum-on-time. This increases the output voltage. If the output voltage is over the regulation threshold, then the error comparator turns the PMOS off for a minimum-off-time until the output drops below the threshold. The NMOS acts as an ideal rectifier that conducts when the PMOS is off. Using an NMOS switch instead of a diode allows for lower voltage drop across the switching device when the NMOS is on. The synchronous switching combination between the PMOS and the NMOS allows the control loop to work in discontinuous mode for light load operations. In discontinuous mode, the MIC23156 works in pulse frequency modulation (PFM) to regulate the output. As the output current increases, the off-time decreases, thus providing more energy to the output. This switching scheme improves the efficiency of MIC23156 during light load currents by only switching when it is needed.

As the load current increases, the MIC23156 goes into continuous conduction mode (CCM) and switches at a frequency centered at 3MHz. The equation to calculate the load when the MIC23156 goes into continuous conduction mode is approximated by Equation 2:

$$I_{LOAD} > \left( \frac{(V_{IN} - V_{OUT}) \times D}{2L \times f} \right) \quad \text{Eq. 2}$$

As shown in Equation 2, the load at which MIC23156 transitions from HyperLight Load mode to PWM mode is a function of the input voltage ( $V_{IN}$ ), output voltage ( $V_{OUT}$ ), duty cycle (D), inductance (L) and frequency (f). The "Switching Frequency vs. Output Current" graph in the [Evaluation Board Performance](#) section shows an example of how, when the output current increases, the switching frequency also increases, until the MIC23156 goes from HyperLight Load mode to PWM mode at approximately 180mA. The MIC23156 switches at a relatively constant frequency around 3MHz after the output current is over 180mA.

# Evaluation Board Performance

**Efficiency ( $V_{OUT} = 2.4V$ ) vs. Output Current**

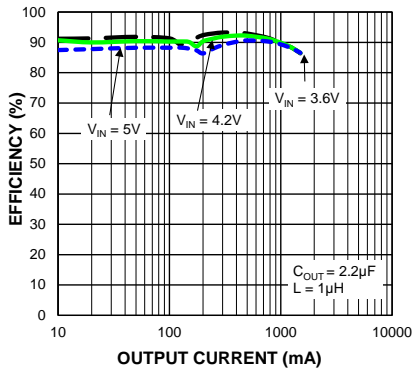

**Efficiency ( $V_{OUT} = 1.8V$ ) vs. Output Current**

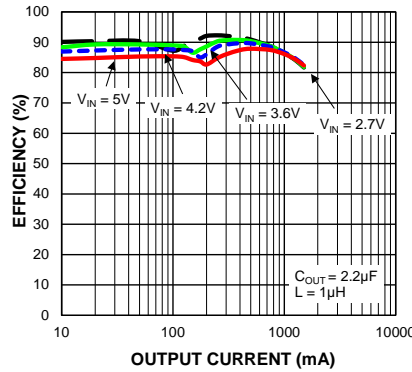

**Efficiency ( $V_{OUT} = 1.0V$ ) vs. Output Current**

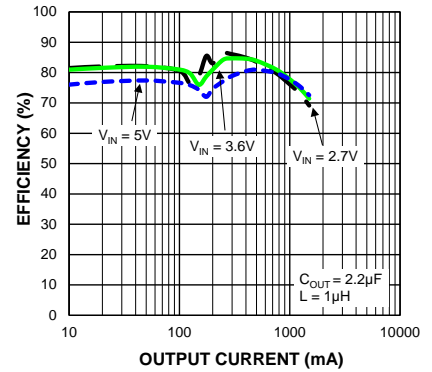

**Quiescent Current vs. Input Voltage**

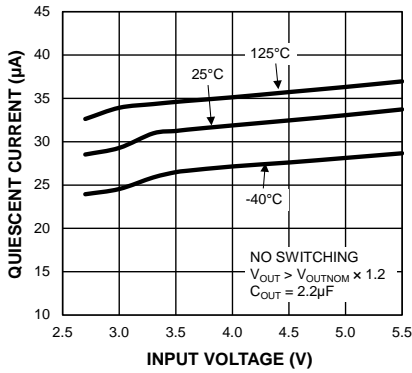

**Enable Threshold vs. Input Voltage**

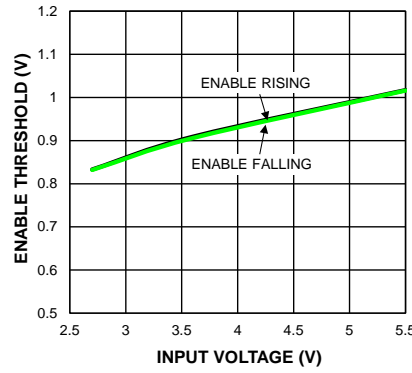

**Output Voltage vs. DAC Linearity**

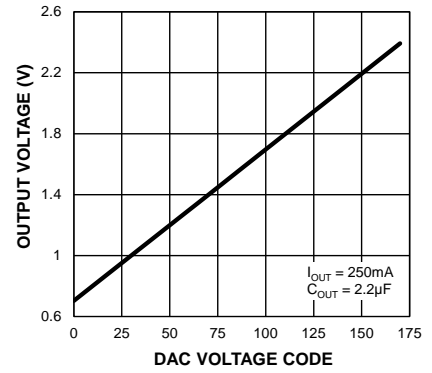

**$\Delta$  Output Voltage vs. DAC DNL**

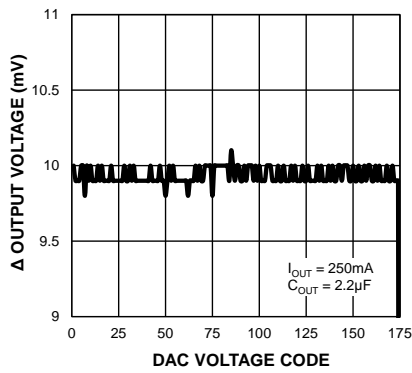

**$V_{OUT}$  Rise Time vs.  $C_{SS}$**

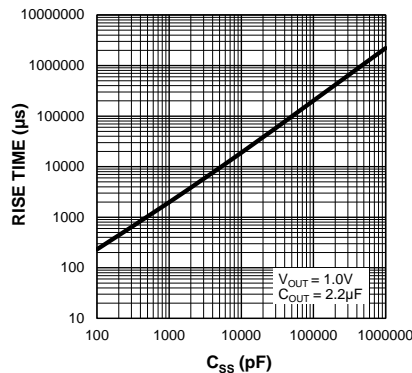

**Switching Frequency vs. Output Current**

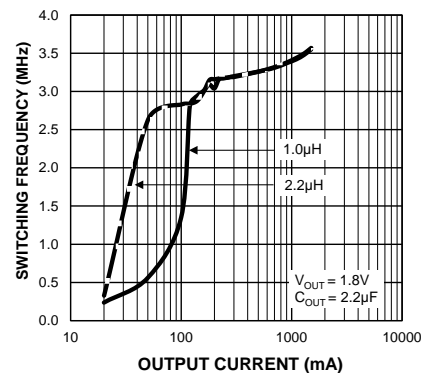

### Evaluation Board Schematic – MIC23156-0YML

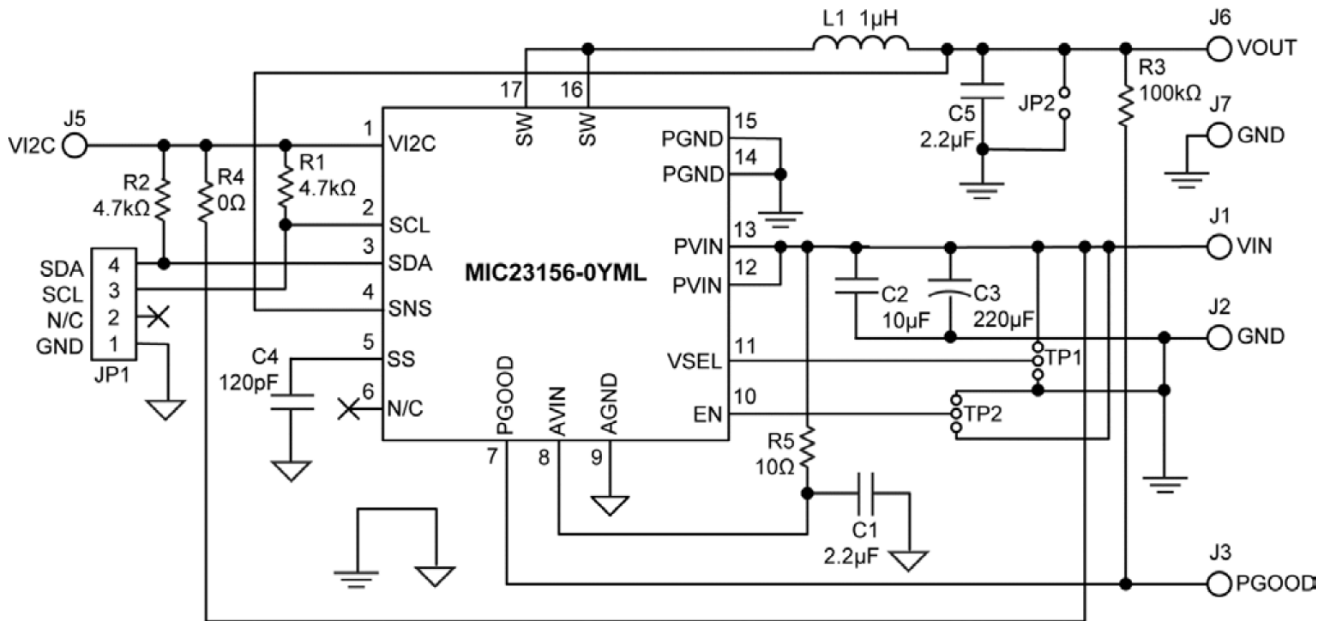

### Evaluation Board Schematic – MIC23156-0YCS

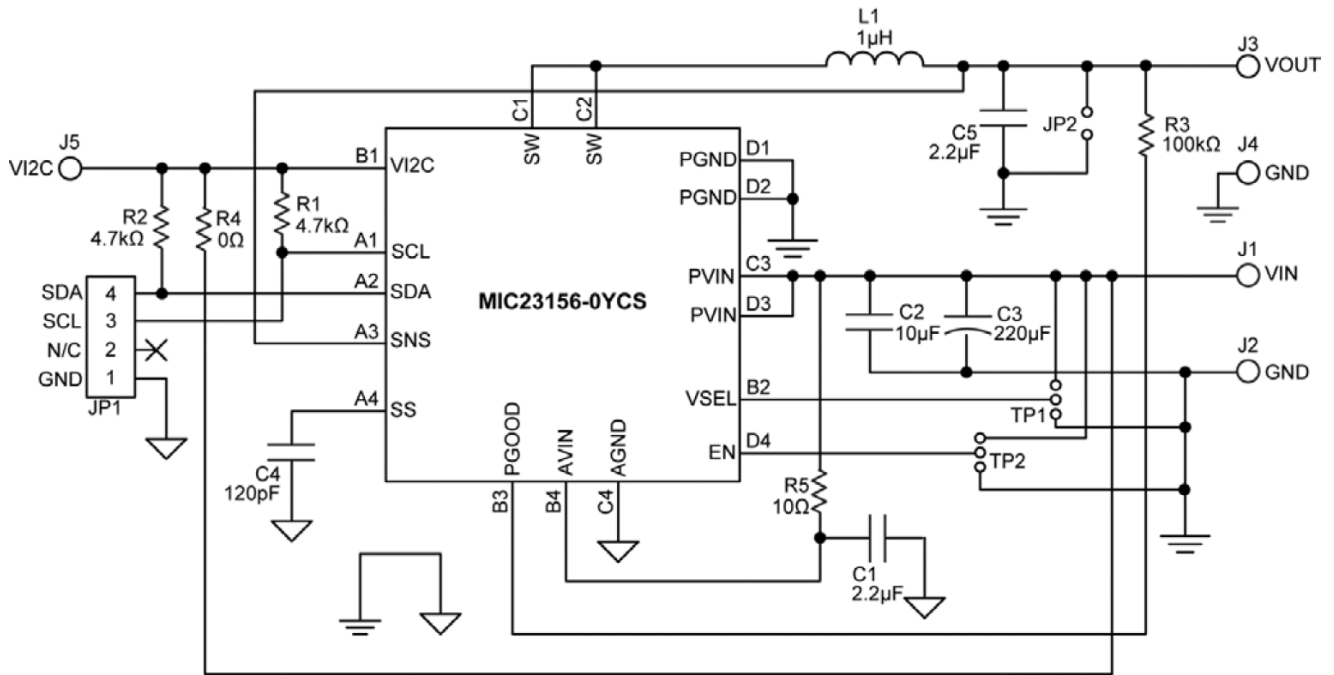

## Bill of Materials

Item	Part Name	Manufacturer	Description	Qty.
C1, C5	06036D225KAT2A	AVX <sup>(2)</sup>	2.2μF, 6.3V, X5R, 0603	2
	GRM188R60J225KE19D	Murata <sup>(3)</sup>		
	C1608X5R0J225KT	TDK <sup>(4)</sup>		
C2	06036D106MAT2A	AVX	10μF, 6.3V, X5R, 0603	1
	GRM188R60J106ME47D	Murata		
	C1608X5R0J106M	TDK		
C3	ECA-1AHG221	Panasonic <sup>(5)</sup>	Aluminum capacitor, 220μF, 10V, 20%, radial	1
C4	06035A121JAT2A	AVX	120pF, 50V, 0603	1
	GRM1885C1H121JA01D	Murata		
	C1608C0G1H121JT	TDK		
L1	CDRH4D28CLDNP-1R0P	Sumida <sup>(6)</sup>	1μH, 3.0A, 14mΩ, L5.1mm × W5.1mm × H3.0mm	1
	LQH44PN1R0NJ0	Murata	1μH, 2.0A, 48mΩ, L4.0mm × W4.0mm × H1.1mm	
R1, R2	CRCW06034K70FKEA	Vishay/Dale <sup>(7)</sup>	4.7kΩ, 1%, 1/10W, 0603	2
R3	CRCW06031003FKEA	Vishay/Dale	100kΩ, 1%, 1/10W, 0603	1
R4	CRCW06030000Z0EA	Vishay/Dale	0Ω, 1/10W, 0603	1
R5	CRCW060310R0FKEA	Vishay/Dale	10Ω, 1%, 1/10W, 0603	1
U1	MIC23156-0YML	Micrel, Inc. <sup>(8)</sup>	1.5A, 3MHz Synchronous Buck Regulator with HyperLight Load and I <sup>2</sup> C Control for Dynamic Voltage Scaling	1

### Notes:

2. AVX: [www.avx.com](http://www.avx.com).
3. Murata: [www.murata.com](http://www.murata.com).
4. TDK: [www.tdk.com](http://www.tdk.com).
5. Panasonic: [www.industrial.panasonic.com](http://www.industrial.panasonic.com).
6. Sumida: [www.sumida.com](http://www.sumida.com).
7. Vishay: [www.vishay.com](http://www.vishay.com).
8. Micrel, Inc.: [www.micrel.com](http://www.micrel.com).



### PCB Layout Recommendations (MLF Package)

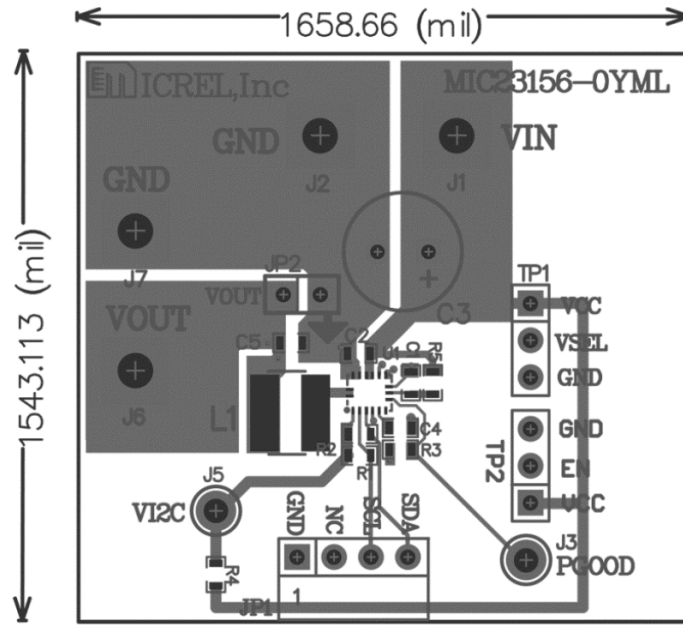

Top Layer

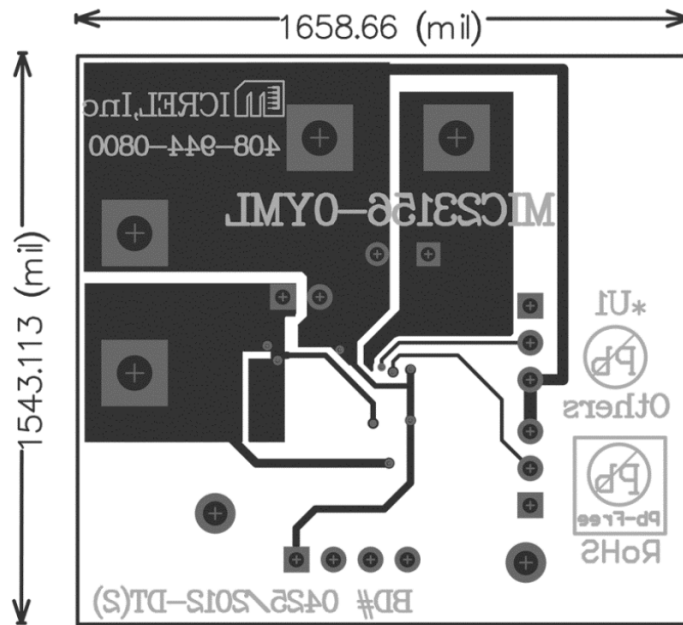

Bottom Layer

### PCB Layout Recommendations (YCS Package)

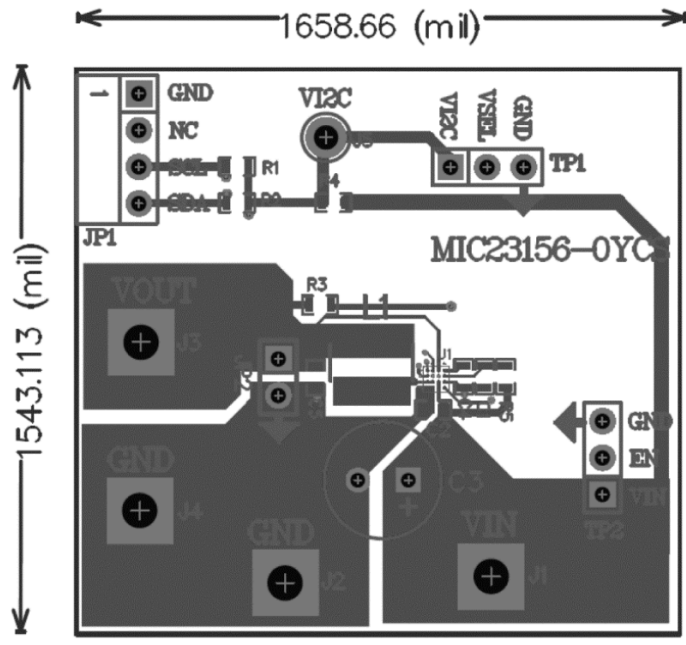

Top Layer

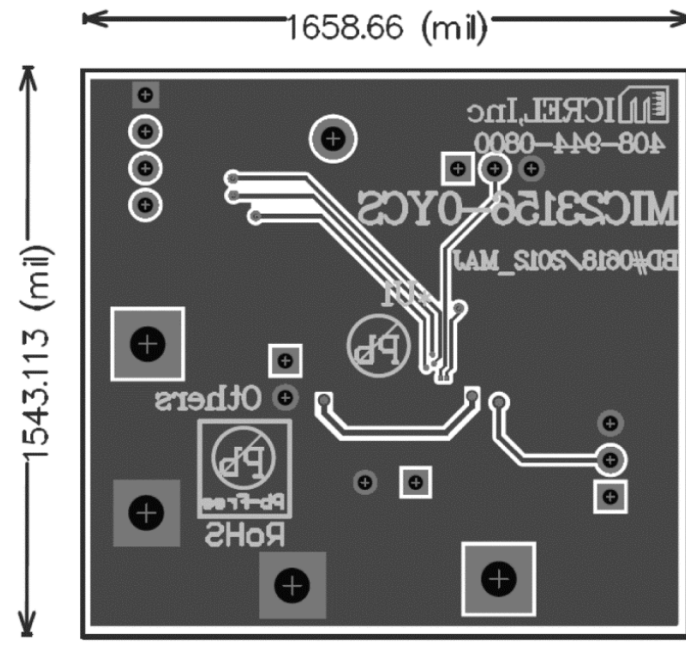

Bottom Layer

---

**MICREL, INC. 2180 FORTUNE DRIVE SAN JOSE, CA 95131 USA**  
TEL +1 (408) 944-0800 FAX +1 (408) 474-1000 WEB <http://www.micrel.com>

Micrel makes no representations or warranties with respect to the accuracy or completeness of the information furnished in this data sheet. This information is not intended as a warranty and Micrel does not assume responsibility for its use. Micrel reserves the right to change circuitry, specifications and descriptions at any time without notice. No license, whether express, implied, arising by estoppel or otherwise, to any intellectual property rights is granted by this document. Except as provided in Micrel's terms and conditions of sale for such products, Micrel assumes no liability whatsoever, and Micrel disclaims any express or implied warranty relating to the sale and/or use of Micrel products including liability or warranties relating to fitness for a particular purpose, merchantability, or infringement of any patent, copyright or other intellectual property right.

Micrel Products are not designed or authorized for use as components in life support appliances, devices or systems where malfunction of a product can reasonably be expected to result in personal injury. Life support devices or systems are devices or systems that (a) are intended for surgical implant into the body or (b) support or sustain life, and whose failure to perform can be reasonably expected to result in a significant injury to the user. A Purchaser's use or sale of Micrel Products for use in life support appliances, devices or systems is a Purchaser's own risk and Purchaser agrees to fully indemnify Micrel for any damages resulting from such use or sale.

© 2013 Micrel, Incorporated.