

SF2242B

40 MHz

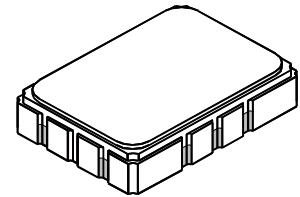

SMP-03

- **Compact 40 MHz SAW Filter Design**
- **Hermetic 5 x 7 mm Surface-mount Case**
- **Complies with Directive 2002/95/EC (RoHS)**
- **Moisture Sensitivity Level: 1**

Absolute Maximum Ratings

Rating	Value	Units
Maximum Incident Power in Passband	+10	dBm
DC Voltage on any Non-ground Terminal	5	VDC
Storage Temperature Range in Tape and Reel	-40 to +85	°C
Suitable for Lead-free Soldering - Maximum Soldering Profile	260 °C for 30 s	

Characteristic	Sym	Notes	Min	Typ	Max	Units
Center Frequency	f_C			40		MHz
Minimum insertion Loss	IL_{MIN}			9.5	12.0	dB
3 dB Bandwidth			3.5	5.0		MHz
Amplitude Ripple, ($f_C - 1.75$ MHz to $f_C + 1.75$ MHz)				1.4	2.0	dB _{P-P}
Group Delay Ripple, ($f_C - 1.75$ MHz to $f_C + 1.75$ MHz)				190	250	ns _{P-P}
Attenuation Relative to IL_{MIN} :						dB
$f_C - 5$ MHz, $f_C + 5$ MHz			20	26		
27.5 to 32.5 MHz			31	40		
47.5 to 52.5 MHz			31	46		
0 to 30.0 MHz			35	64		
50.0 to 70.0 MHz			35	40		
Operating Temperature Range	T_A		-40		+85	°C

Terminating Source Impedance (through matching network)		$Z_S = 50$ ohms
Terminating Source Impedance (through matching network)		$Z_L = 50$ ohms
Case Style		SMP-03 7 x 5 mm Nominal Footprint
Lid Symbolization (YY = year, WW = week, S = shift, ## = Sequence Code)		RFM, SF2242B, YYWWS##



CAUTION: Electrostatic Sensitive Device. Observe precautions for handling.

NOTES:

1. The design, manufacturing process, and specifications of this device are subject to change.
2. US or International patents may apply.
3. RoHS compliant from the first date of manufacture.

Filter Response Plots

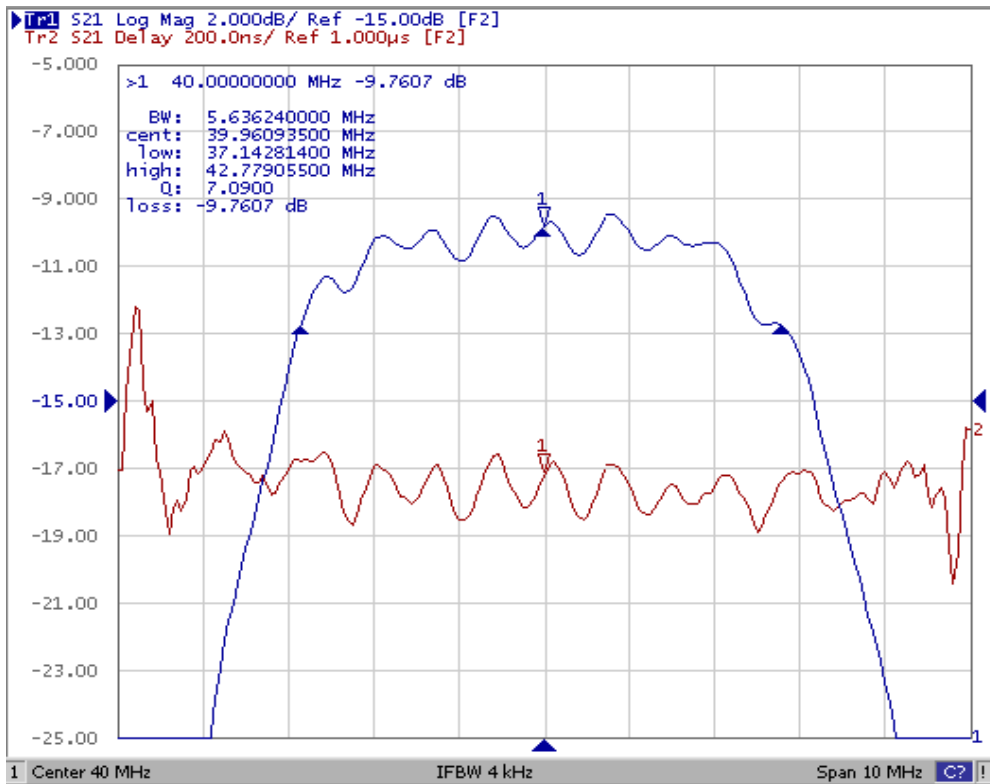
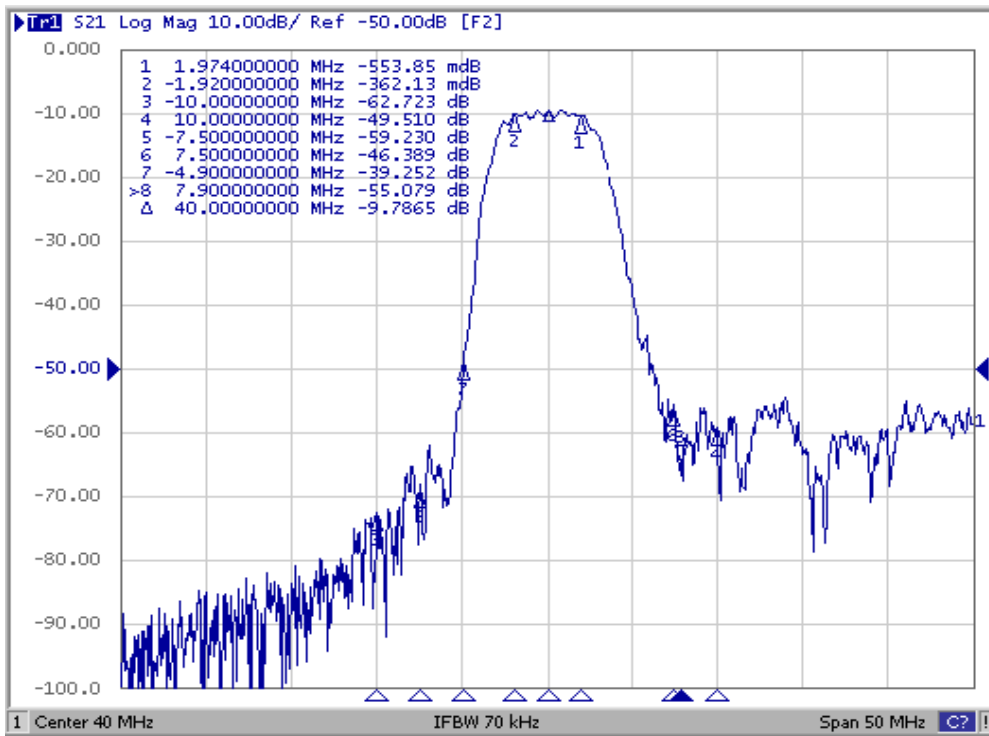

Filter Input/Output Impedance Plots

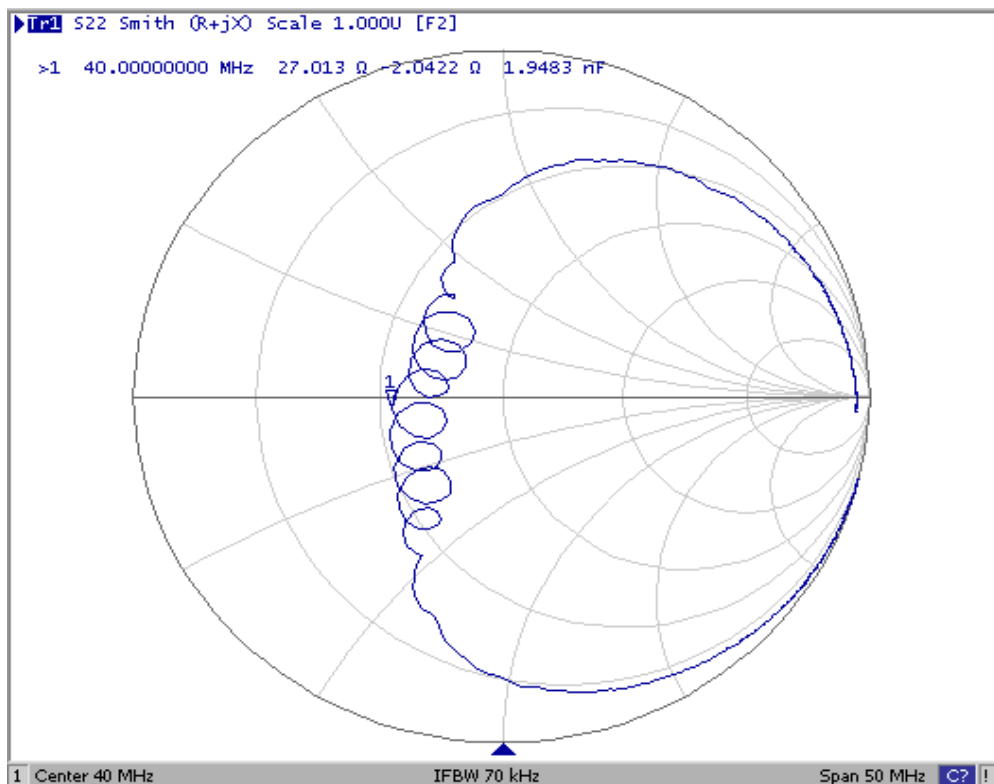
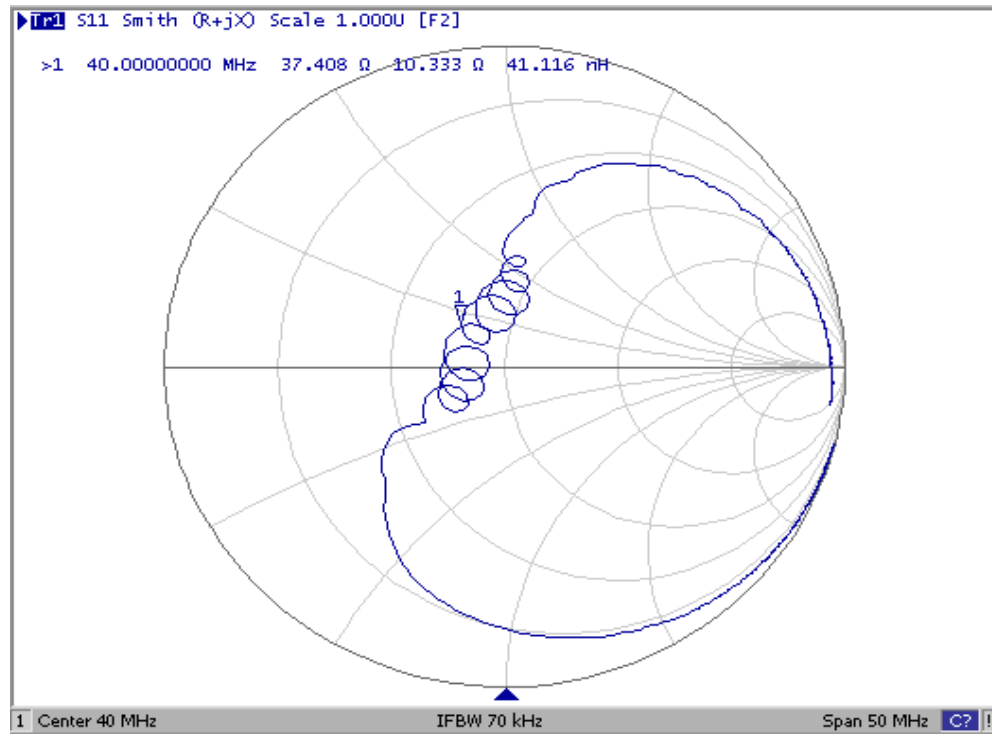

SMP-03 10-Terminal Ceramic Surface-mount Case

5 x 7 mm Nominal Footprint

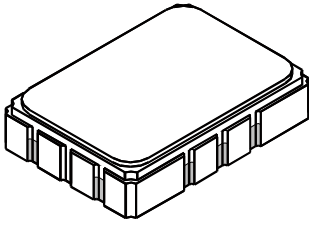

Recommended PCB Footprint

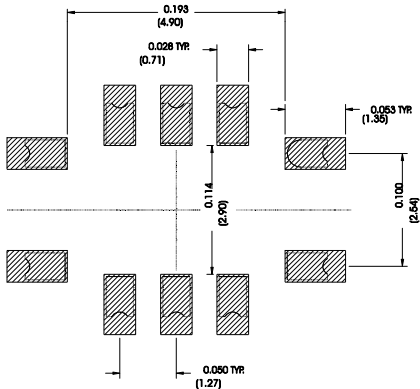

Matching Circuit

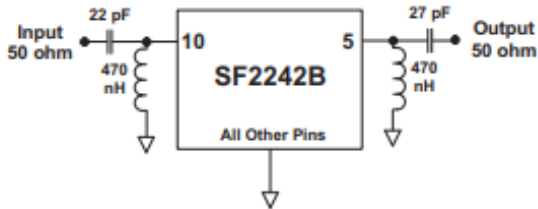

Case Dimensions						
Dimension	mm			Inches		
	Min	Nom	Max	Min	Nom	Max
A	6.80	7.00	7.20	0.268	0.276	0.283
B	4.80	5.00	5.20	0.189	0.197	0.205
C	-	1.65	2.00	-	0.065	0.079
D	0.47	0.60	0.73	0.019	0.024	0.029
E	2.41	2.54	2.67	0.095	0.100	0.105
H	0.87	1.0	1.13	0.034	0.039	0.044
J	4.87	5.00	5.13	0.192	0.197	0.202
K	2.87	3.00	3.13	0.113	0.118	0.123
P	1.14	1.27	1.40	0.045	0.050	0.055

Electrical Connections	
Single-Ended Connection	Terminals
Input	10
Output	5
Ground	All others
Differential Connection	Terminals
Input	10, 1
Output	5, 6
Ground	All others

Case Materials	
Solder Pad Plating	0.3 to 1.0 μm Gold over 1.27 to 8.89 μm Nickel
Lid Plating	2.0 to 3.0 μm Nickel
Body	Al_2O_3 Ceramic

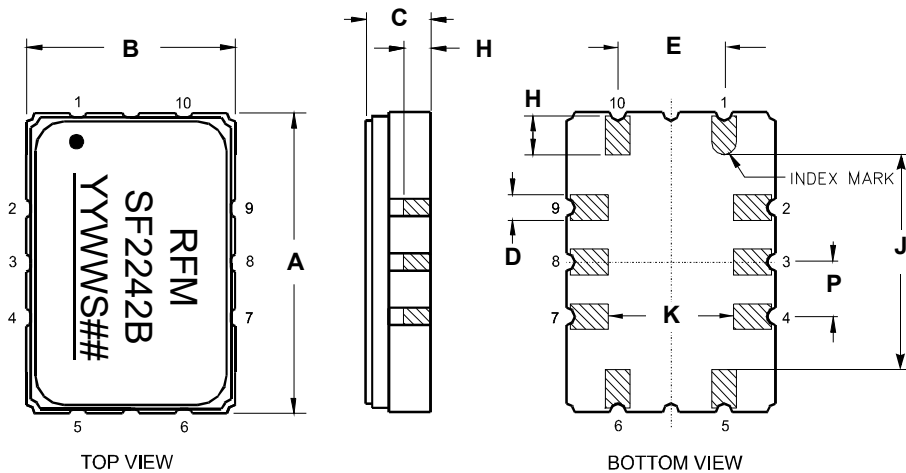

Tape and Reel Specifications

Tape and Reel Standard per ANSI/EIA481

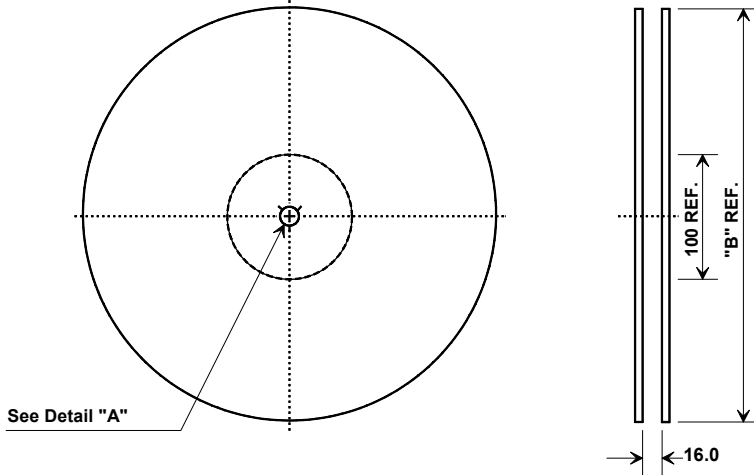

"B" Nominal Size		Quantity Per Reel
Inches	millimeters	
7	178	500
13	330	2000

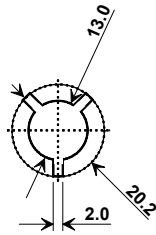

COMPONENT ORIENTATION and DIMENSIONS

Carrier Tape Dimensions	
Ao	5.6 mm
Bo	7.6 mm
Ko	2.0 mm
Pitch	8.0 mm
W	16.0 mm

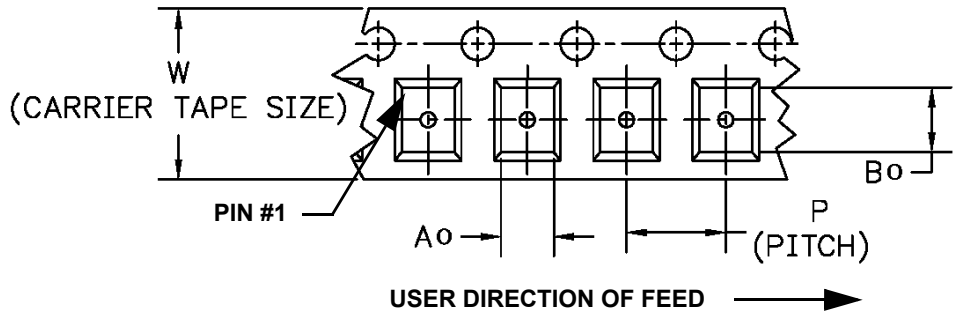
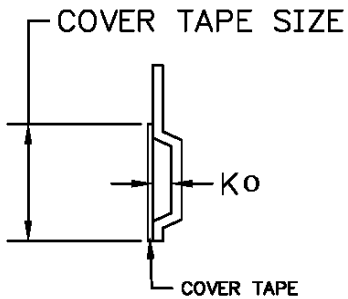

Recommended Reflow Profile

1. Preheating shall be fixed at 150~180° for 60~90 seconds.
2. Ascending time to preheating temperature 150° shall be 30 seconds min.
3. Heating shall be fixed at 220°C for 50~80 seconds and at 260°C peak (10 seconds.)
4. Time: 5 times maximum

