

Data sheet | Item number: 890-124

Socket; with strain relief housing; 4-pole; Cod. A; 1,50 mm²; white

www.wago.com/890-124



Color: ■

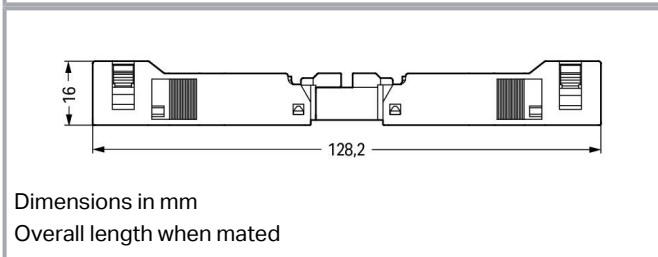
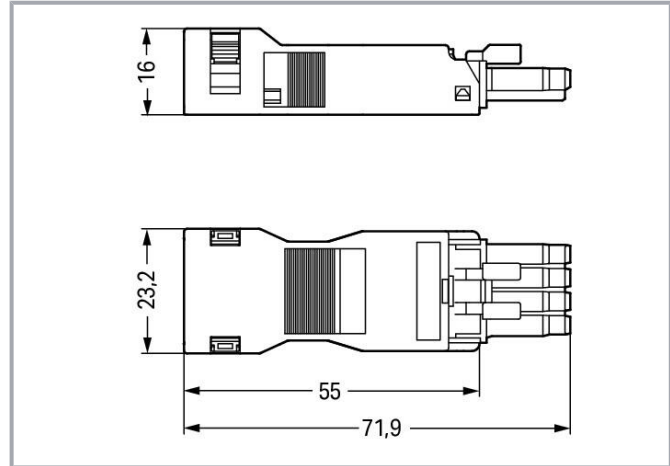

Dimensions in mm
Overall length when mated

Item description

Female connector/socket *WINSTA*® MINI with protection type IP40

The *WINSTA*® MINI female connector/socket 4-pole is the pluggable solution for your application in control cabinets, on PCBs or for lighting connections. On PCBs, in control cabinets or for connecting lights – pluggable installation connectors from WAGO allow you to make connections

Subject to changes. Please also observe the further product documentation!

WAGO GmbH & Co. KG
Hansastr. 27
32423 Minden
Phone: +49571 887-0 | Fax: +49571 887-169
Email: info.de@wago.com | Web: www.wago.com

Do you have any questions about our products?
We are always happy to take your call at +49 (571) 887-44222.



according to many different requirements in next to no time. The mechanical coding and color coding of the pluggable installation connector ensure error-free installation of the individual components – including protection against mismatching. The pluggable installation connector is protected in accordance with protection type IP40. Users' fingers and tools will never come into contact with live elements. Standard mains applications for almost any domain of use can be implemented with *WINSTA*® MINI pluggable installation connectors with A coding. If only limited space is available, our smallest pluggable connection system, *WINSTA*® MINI, consistently displays its advantageous properties. It saves space, and, thanks to Push-in CAGE CLAMP® spring pressure connection technology, it also saves time, since the installation is low-maintenance and requires no screw connections. A range up to 45 mm can be used for the strip length.

WINSTA® MINI solutions for your electrical installation – protected against mismatching and maintenance-free

The *WINSTA*® Pluggable Connection System allows pluggable electrical installation. This significantly reduces the need for servicing and lowers costs. Take advantage of the pluggable version of our maintenance-free spring pressure connection technology too! Plan your installation with *WINSTA*® MINI pluggable installation connectors with protection against mismatching from WAGO.

- pluggable installation connectors with protection against mismatching
- easy tool-free operation, a wide range of coding options
- suitable for any application
- custom-engineered solutions
- rapid, structured electrical installation

Data

Electrical data

Ratings per IEC/EN

| Ratings per | IEC/EN 60664-1 |
|-------------------------------|-----------------------------------------------------------|
| Nominal voltage (III/3) | 400 V |
| Rated impulse voltage (III/3) | 6 kV |
| Rated current | 16 A |
| Legend (ratings) | (III / 3) ≙ Overvoltage category III / Pollution degree 3 |

Ratings per UL 1977

| | |
|-------------------------|-----------------------------------------------------------------------------------------------------------------------------------------------------------------------------------------------------------------------------------------|
| Note for the US market | Some versions may also be used for current interruption in accordance with the UL certificate in select applications with currents below 5 A and voltages up to 600 V. For further information, please contact your local sales office. |
| Rated voltage (UL 1977) | 600 V |
| Rated current UL 1977 | 12 A |

Subject to changes. Please also observe the further product documentation!



General

| | |
|----------------------------|--------------------------------------------------------------------------------------|
| Note on contact resistance | approx. 1 mΩ of contact resistance approx. 0.25 mΩ contact transition plug/socket |
|----------------------------|--------------------------------------------------------------------------------------|

Connection data

| | |
|----------------------------|---|
| Connection points | 4 |
| Total number of potentials | 4 |

Connection 1

| | |
|------------------------------------------------------------|-----------------------------------------------|
| Connection technology | Push-in CAGE CLAMP® |
| Actuation type | Operating tool Push-in |
| Nominal cross-section | 1.5 mm ² / 16 AWG |
| Solid conductor | 0.25 ... 1.5 mm ² / 22 ... 16 AWG |
| Solid conductor; push-in termination | 0.75 ... 1.5 mm ² / 20 ... 16 AWG |
| Stranded conductor | 0.25 ... 1 mm ² / 22 ... 18 AWG |
| Fine-stranded conductor | 0.25 ... 1.5 mm ² / 22 ... 16 AWG |
| Fine-stranded conductor; with insulated ferrule | 0.25 ... 0.75 mm ² / 22 ... 20 AWG |
| Fine-stranded conductor; with uninsulated ferrule | 0.25 ... 0.75 mm ² / 22 ... 20 AWG |
| Fine-stranded conductor; with ferrule; push-in termination | 0.75 mm ² / 20 AWG |
| Strip length | 9 mm / 0.35 inches |
| Pole number | 4 |
| Conductor entry direction to mating direction | 0° |
| Strip length (outer insulation) | 45 mm |

Physical data

| | |
|-------------|------------------------|
| Pin spacing | 4.4 mm / 0.173 inches |
| Width | 23.2 mm / 0.913 inches |
| Height | 16 mm / 0.63 inches |
| Depth | 71.9 mm / 2.831 inches |

Mechanical Data

| | |
|-----------------|----------------------------|
| Application | General mains applications |
| Coding | A |
| Variable coding | No |
| Marking | |

Subject to changes. Please also observe the further product documentation!



| | |
|-----------------------------------------|----------------------------------------------------------|
| | N ∇ 2/L 1/L' |
| Potential marking | N ∇ 2/L 1/L' |
| Mating force of a plug-in connection | approx. 20 ... 70 N (depending on pole number) |
| Retention force of a plug-in connection | Locked: > 80 N |
| Unmating force of a plug-in connection | Unlocked: approx. 20 ... 70 N (depending on pole number) |
| Number of mating cycles | 200, without resistive load |
| Protection type | IP40 |

Plug-in connection

| | |
|------------------------------------|------------------------------------------------------------------------------------------------------------------------------------------------------------------------------------------------------------------------------------------------------------------------------------------------------------------|
| Contact type (pluggable connector) | Female connector/socket |
| Connector (connection type) | for conductor |
| Mismating protection | Yes |
| Note on mismating protection | All WINSTA [®] components are 100% protected against mismating when: a.) plugging different numbers of poles b.) plugging while rotated 180 c.) plugging while laterally staggered d.) plugging one pole |
| Locking lever | Can be retrofitted |
| Locking of plug-in connection | locking lever |
| Note on locking system | All connectors for mounted installations (snap-in versions for lighting fixtures or devices, all types of PCB and distribution connectors) are factory-equipped with locking levers to ensure plugs and sockets are securely locked. Additional locking levers are only required for flying leads (plug/socket). |
| Strain relief | strain relief housing |

Material Data

| | |
|-----------------------------|----------------------------------------------------------|
| Note (material data) | Information on material specifications can be found here |
| Color | white |
| Cover color | gray |
| Material group | I |
| Insulation material | Polyamide (PA66) |
| Flammability class per UL94 | V0 |
| Clamping spring material | Chrome-nickel spring steel (CrNi) |
| Contact material | Copper or copper alloy; surface-treated |
| Contact plating | Tin |

Subject to changes. Please also observe the further product documentation!

| | |
|-----------|---------|
| Fire load | 0.29 MJ |
| Weight | 10.6 g |

Environmental requirements

| | |
|------------------------------------------|--------------------------------------------|
| Processing temperature | -5 ... +40 °C |
| Continuous operating temperature | -35 ... +85 °C |
| Note on continuous operating temperature | Insulating parts for temperatures ≤ 105 °C |

Commercial data



| | |
|-----------------------|---------------|
| Product Group | 20 (Winsta) |
| eCl@ss 10.0 | 27-44-06-05 |
| eCl@ss 9.0 | 27-44-06-05 |
| ETIM 8.0 | EC002560 |
| ETIM 7.0 | EC002560 |
| PU (SPU) | 50 pcs |
| Packaging type | box |
| Country of origin | DE |
| GTIN | 4045454232979 |
| Customs tariff number | 85366990990 |

Environmental Product Compliance

| | |
|------------------------|-------------------------|
| RoHS Compliance Status | Compliant, No Exemption |
|------------------------|-------------------------|

Approvals / Certificates

General approvals



| Logo | Approval | Additional Approval Text | Certificate name |
|------------------------------------------------------------------------------------|-----------------------------------------|--------------------------|------------------|
|  | CCA DEKRA Certification B.V. | EN 61535 | 71- 123231 |
| | CCA DEKRA Certification B.V. | IEC 61535 | NL-85020 |
|  | cURus Underwriters Laboratories Inc. | UL 1977 | E45171 |

Declarations of conformity and manufacturer's declarations



Subject to changes. Please also observe the further product documentation!

WAGO GmbH & Co. KG
 Hansastr. 27
 32423 Minden
 Phone: +49571 887-0 | Fax: +49571 887-169
 Email: info.de@wago.com | Web: www.wago.com







Do you have any questions about our products?
 We are always happy to take your call at +49 (571) 887-44222.

| Logo | Approval | Additional Approval Text | Certificate name |
|----------------------------------------------------------------------------------|----------------------------------------------------|--------------------------|------------------|
|  | EU-Declaration of Conformity WAGO GmbH & Co. KG | - | - |
|  | UK-Declaration of Conformity WAGO GmbH & Co. KG | - | - |

Approvals for marine applications

| Logo | Approval | Additional Approval Text | Certificate name |
|-------------------------------------------------------------------------------------|--------------------------------------------------|--------------------------|--------------------------|
|  | ABS American Bureau of Shipping | Steel Vessel Rules | 19- HG1869855- PDA |
|  | DNV GL Det Norske Veritas, Germanischer Lloyd | - | TAE00001Z6 |
|  | LR Lloyds Register | EN 61535 | 08/20047 (E2) |

Counterpart

| | | |
|------------------------------------------------------------------------------------|-----------------------------------------------------------------------------------------------------------------------------------|----------------------------------------------------------------|
|  | Item no.890-134 Plug; with strain relief housing; 4-pole; 1,50 mm ² ; white | www.wago.com/890-134 |
|  | Item no.890-234 Plug; 4-pole; Cod. A; 1,50 mm ² ; white | www.wago.com/890-234 |
|  | Item no.890-676 T-distribution connector; 4-pole; Cod. A; 1 input; 2 outputs; 2 locking levers; white | www.wago.com/890-676 |
|  | Item no.890-677 T-distribution connector; 4-pole; Cod. A; 1 input; 2 outputs; 3 locking levers; for flying leads; white | www.wago.com/890-677 |
|  | Item no.890-734 Snap-in plug; 4-pole; Cod. A; 1,50 mm ² ; white | www.wago.com/890-734 |
|  | Item no.890-834 | |

Subject to changes. Please also observe the further product documentation!

Plug for PCBs; straight; 4-pole; Cod. A; white

www.wago.com/890-834



Item no.890-834/011-000

Plug for PCBs; angled; 4-pole; Cod. A; white

www.wago.com/890-834/011-000



Item no.890-995

h-distribution connector; 4-pole; Cod. A; 1 input; 2 outputs; outputs on one side; 3 locking levers; for flying leads; white

www.wago.com/890-995



Item no.890-994

h-distribution connector; 4-pole; Cod. A; 1 input; 2 outputs; outputs on one side; 2 locking levers; white

www.wago.com/890-994



Item no.891-8994/006-102

pre-assembled interconnecting cable; Eca; Socket/plug; 4-pole; Cod. A; H05VV-F 4G 1.5 mm²; 1 m; 1,50 mm²; white

www.wago.com/891-8994/006-102



Item no.891-8994/206-102

pre-assembled connecting cable; Eca; Plug/open-ended; 4-pole; Cod. A; H05VV-F 4G 1.5 mm²; 1 m; 1,50 mm²; white

www.wago.com/891-8994/206-102

Required accessories

Locking levers

Locking system



Item no.: 890-111

Locking lever; for flying leads; for tool operation; black

www.wago.com/890-111



Item no.: 890-101

Locking lever; for manual operation; black

www.wago.com/890-101



Item no.: 890-121

Locking lever; for manual operation; white

www.wago.com/890-121



Item no.: 890-131

Locking lever; for flying leads; for tool operation; white

www.wago.com/890-131

Optional accessories

Cover

Cover

Subject to changes. Please also observe the further product documentation!

WAGO GmbH & Co. KG

Hansastr. 27

32423 Minden

Phone: +49571 887-0 | Fax: +49571 887-169

Email: info.de@wago.com | Web: www.wago.com

Do you have any questions about our products?

We are always happy to take your call at +49 (571) 887-44222.



Item no.: 897-2003
Protective cap; Type2; for sockets and plugs; PVC; red

www.wago.com/897-2003

Tool

Operating tool



Item no.: 210-719
Operating tool; Blade: 2.5 x 0.4 mm; with a partially insulated shaft

www.wago.com/210-719



Item no.: 890-384
Operating tool; 4-way; green

www.wago.com/890-384

Mounting

Mounting accessories



Item no.: 890-310
Mounting carrier; 2- to 5-pole; for flying leads; black

www.wago.com/890-310



Item no.: 890-311
Mounting carrier; 2- to 5-pole; for flying leads; white

www.wago.com/890-311

Shield termination

Shield termination



Item no.: 890-524
Shield connecting plate; 4-pole; for sockets

www.wago.com/890-524

Downloads

Documentation

Bid Text

| | | | |
|------------------------|-------------|----------------|----------|
| 890-124 X81 - Datei | 2019 Feb 19 | xml 3.1 kB | Download |
| 890-124 doc - Datei | 2015 Jun 8 | doc 23.6 kB | Download |

CAD/CAE-Data

CAD data

| | | |
|----------------------|-----|----------|
| 2D/3D Models 890-124 | URL | Download |
|----------------------|-----|----------|

Subject to changes. Please also observe the further product documentation!

CAE data

| | URL | Download |
|------------------------|---------------------|--------------------------|
| WSCAD Universe 890-124 | | |
| ZUKEN Portal 890-124 | URL | Download |

Environmental Product Compliance

Compliance Search

| | URL | Download |
|----------------------------------------------------------------------------------|---------------------|--------------------------|
| Environmental Product Compliance 890-124 | | |
| Socket; with strain relief housing; 4-pole; Cod. A; 1,50 mm ² ; white | URL | Download |

Installation Notes

Conductor termination

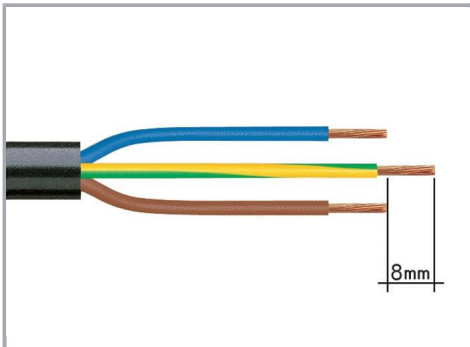

1. Strip length, outer insulation = 30 mm (2-pole), 37 mm (3-pole), 45 mm (4- and 5-pole)
2. Strip length = 9 mm
3. Extended ground conductor = 8 mm

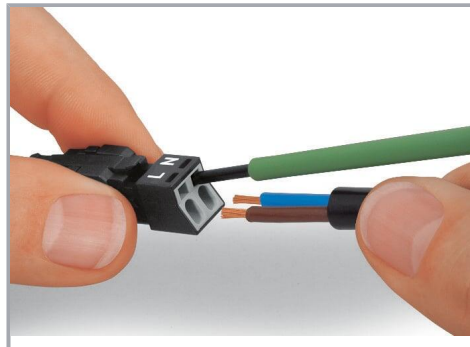

To terminate fine-stranded conductors, open the clamping unit via screwdriver – 2.5 mm blade width – and insert a stripped conductor until it hits the backstop. Terminate solid conductors by simply pushing them in.

Subject to changes. Please also observe the further product documentation!

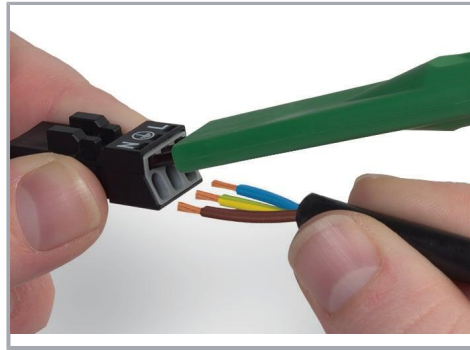
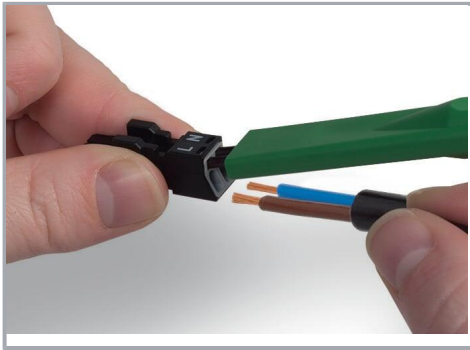

To terminate fine-stranded conductors, open clamping units via operating tool (890-382) and insert stripped conductors until they hit backstop.

To terminate fine-stranded conductors, open clamping units via operating tool (890-383) and insert stripped conductors until they hit backstop.

Terminate solid conductors by simply pushing them in.

Terminate solid conductors by simply pushing them in.

Installation

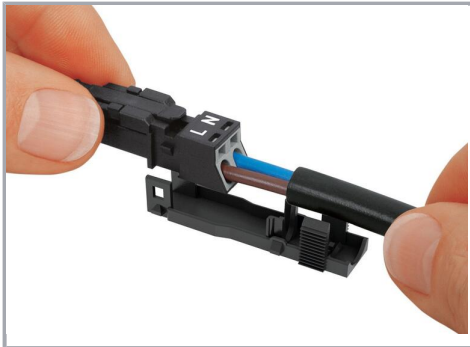

Latch the wired connector into the base of the strain relief housing.

Push down strain relief clamp by hand.

Subject to changes. Please also observe the further product documentation!



Push down strain relief clamp with 2.5 mm screwdriver alternately on both sides.

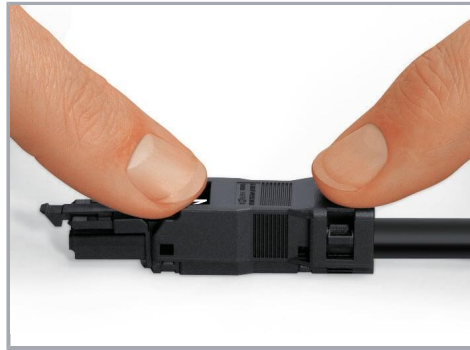

Latch the top of the strain relief housing.



The printed marking of the connector is clearly visible in the openings of the strain relief housing.

Shield termination



Connector with shield termination

Subject to changes. Please also observe the further product documentation!



Apply the shield to the sheathed cable.

Strip length, outer insulation = 30 mm

Shield length = 8 mm



Push the shield connecting plate into the connector until fully inserted.

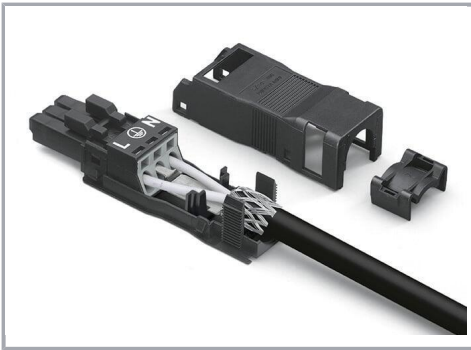

First insert the wired connector into strain relief housing, then snap clamp and cover.

Product family

WINSTA® MINI

[Show all products from the family](#)

Subject to changes. Please also observe the further product documentation!