

# LSY T676

## Multi TOPLED®

Two chip LEDs for indicators that allow to display red, green and yellow by color mixing



## Applications

- Electronic Equipment

## Features:

- Package: white PLCC-4 package, colorless clear resin
- Chip technology: InGaAlP
- Typ. Radiation: 120° (Lambertian emitter)
- Color:  $\lambda_{\text{dom}} = 633 \text{ nm}$  (● super red);  $\lambda_{\text{dom}} = 587 \text{ nm}$  (● yellow)
- Optical efficacy: 7 lm/W; 11 lm/W
- Corrosion Robustness Class: 3B
- Qualifications: The product qualification test plan is based on the guidelines of AEC-Q101-REV-C, Stress Test Qualification for Automotive Grade Discrete Semiconductors.
- ESD: 2 kV acc. to ANSI/ESDA/JEDEC JS-001 (HBM, Class 2)

---

## Ordering Information

Type	Brightness <sup>1)</sup>	Ordering Code
LSY T676-P2R1-1-0+Q2S1-35		Q65110A2446
• super red	• $I_v = 56 \dots 140 \text{ mcd}$ ( $I_F = 20 \text{ mA}$ )	
• yellow	• $I_v = 90 \dots 224 \text{ mcd}$ ( $I_F = 20 \text{ mA}$ )	

---

## Maximum Ratings

Parameter	Symbol		Values	Values
			● super red	● yellow
Operating Temperature	$T_{op}$	min.	-40 °C	-40 °C
		max.	100 °C	100 °C
Storage Temperature	$T_{stg}$	min.	-40 °C	-40 °C
		max.	100 °C	100 °C
Junction Temperature	$T_j$	max.	125 °C	125 °C
Forward Current $T_A = 25\text{ °C}$	$I_F$	max.	30 mA	30 mA
Surge Current $t \leq 10\ \mu\text{s}$ ; $D = 0.005$ ; $T_A = 25\text{ °C}$	$I_{FS}$	max.	1 A	0.2 A
Reverse voltage <sup>2)</sup> $T_A = 25\text{ °C}$	$V_R$	max.	12 V	12 V
ESD withstand voltage acc. to ANSI/ESDA/JEDEC JS-001 (HBM, Class 2)	$V_{ESD}$		2 kV	2 kV

## Characteristics

$I_F = 20 \text{ mA}$ ;  $T_A = 25 \text{ °C}$

Parameter	Symbol		Values	Values
			● super red	● yellow
Peak Wavelength	$\lambda_{\text{peak}}$	typ.	645 nm	591 nm
Dominant Wavelength <sup>3)</sup>	$\lambda_{\text{dom}}$	min.	627 nm	583 nm
		typ.	633 nm	587 nm
		max.	639 nm	592 nm
Spectral bandwidth at 50% $I_{\text{rel,max}}$	$\Delta\lambda$	typ.	16 nm	15 nm
Viewing angle at 50% $I_V$	$2\varphi$	typ.	120 °	120 °
Forward Voltage <sup>4)</sup> $I_F = 20 \text{ mA}$	$V_F$	min.	1.80 V	1.90 V
		typ.	2.00 V	2.00 V
		max.	2.30 V	2.40 V
Reverse current <sup>2)</sup> $V_R = 12 \text{ V}$	$I_R$	max.	10 $\mu\text{A}$	10 $\mu\text{A}$
Temperature Coefficient of Peak Wavelength	$\text{TC}_{\lambda_{\text{peak}}}$	typ.	0.14 nm / K	0.13 nm / K
Temperature Coefficient of Dominant Wavelength	$\text{TC}_{\lambda_{\text{dom}}}$	typ.	0.05 nm / K	0.1 nm / K
Temperature Coefficient of Forward Voltage	$\text{TC}_{V_F}$	typ.	-2 mV / K	-2.5 mV / K
Real thermal resistance junction/solderpoint <sup>5)</sup> 1 chip on	$R_{\text{thJS real}}$	max.	340 K / W	340 K / W

## Brightness Groups

Color of emission	Group	Luminous Intensity <sup>1)</sup> I <sub>F</sub> = 20 mA min. I <sub>v</sub>	Luminous Intensity <sup>1)</sup> I <sub>F</sub> = 20 mA max. I <sub>v</sub>	Luminous Flux <sup>6)</sup> I <sub>F</sub> = 20 mA typ. Φ <sub>v</sub>
● super red	P2	56 mcd	71 mcd	190 mlm
● super red	Q1	71 mcd	90 mcd	240 mlm
● super red	Q2	90 mcd	112 mcd	300 mlm
● super red	R1	112 mcd	140 mcd	380 mlm
● yellow	Q2	90 mcd	112 mcd	300 mlm
● yellow	R1	112 mcd	140 mcd	380 mlm
● yellow	R2	140 mcd	180 mcd	480 mlm
● yellow	S1	180 mcd	224 mcd	610 mlm

## Wavelength Groups

- super red

Group	Dominant Wavelength <sup>3)</sup> min. λ <sub>dom</sub>	Dominant Wavelength <sup>3)</sup> max. λ <sub>dom</sub>
1	627 nm	639 nm

## Wavelength Groups

- yellow

Group	Dominant Wavelength <sup>3)</sup> min. λ <sub>dom</sub>	Dominant Wavelength <sup>3)</sup> max. λ <sub>dom</sub>
3	583 nm	586 nm
4	586 nm	589 nm
5	589 nm	592 nm

---

## Group Name on Label

Example: P2-1+Q2-3

Color	Brightness	Wavelength
● super red	P2	1
● yellow	Q2	3

### Relative Spectral Emission <sup>6)</sup>

$I_{rel} = f(\lambda); I_F = 20 \text{ mA}; T_A = 25 \text{ }^\circ\text{C}$

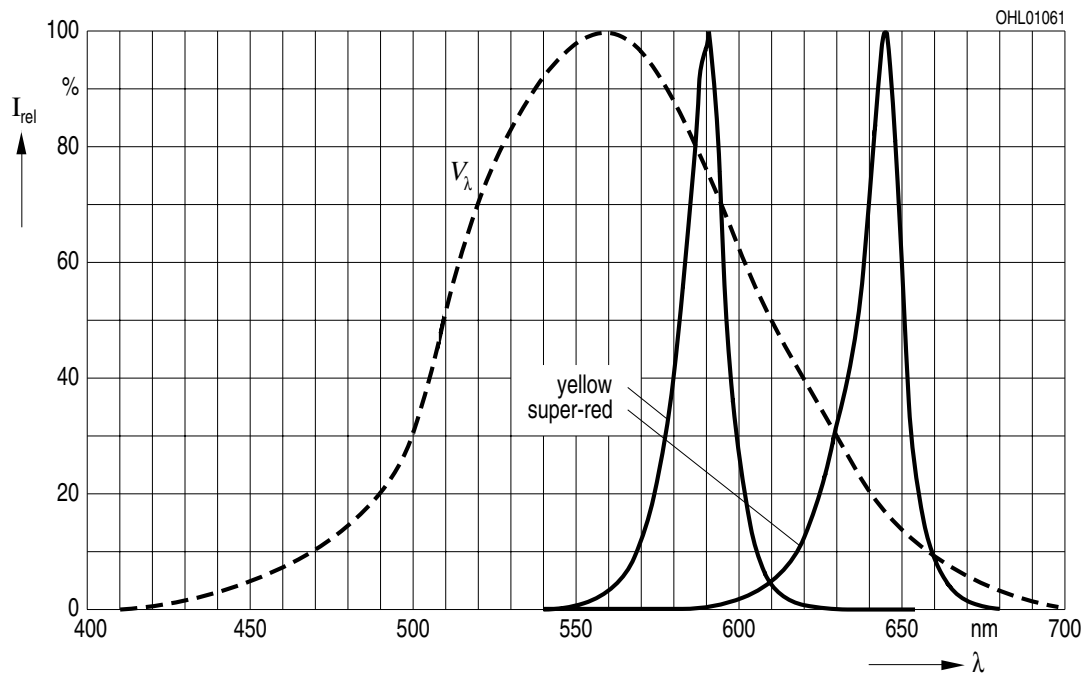

### Radiation Characteristics <sup>6)</sup>

$I_{rel} = f(\phi); T_A = 25 \text{ }^\circ\text{C}$

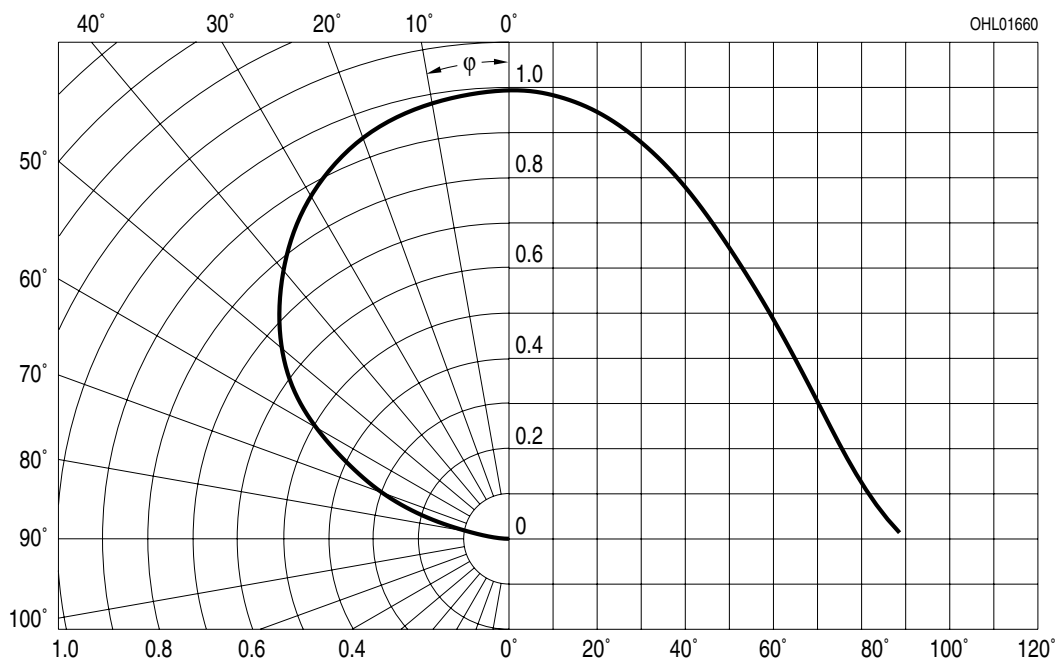

**Forward current** <sup>6)</sup>

$I_F = f(V_F); T_A = 25\text{ °C}$

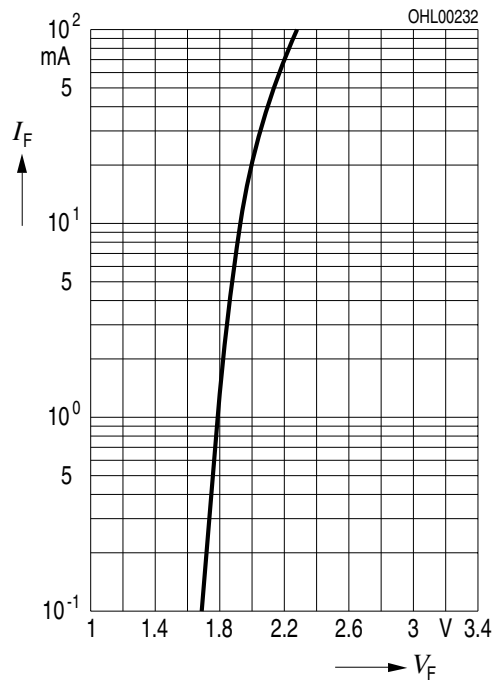

**Relative Luminous Intensity** <sup>6), 7)</sup>

$I_V/I_{V(20\text{ mA})} = f(I_F); T_A = 25\text{ °C}$

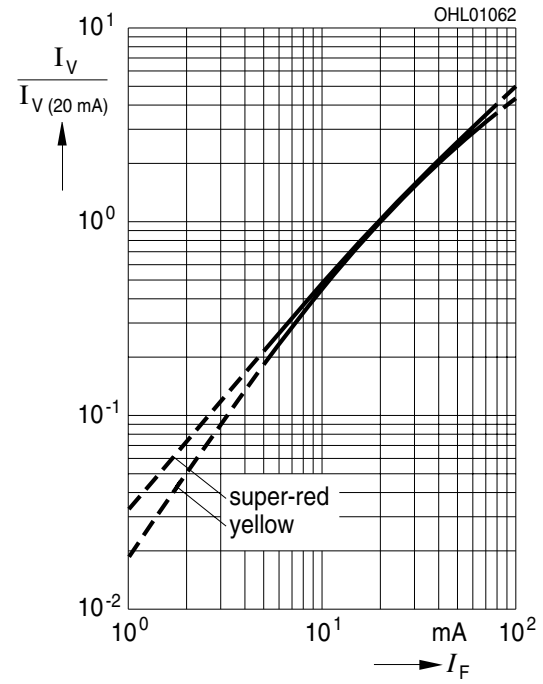



## Relative Luminous Intensity <sup>6)</sup>

- super red:  $I_{v,rel} = f(T_A)$ ; 1 chip on ;  $I_F = 20$

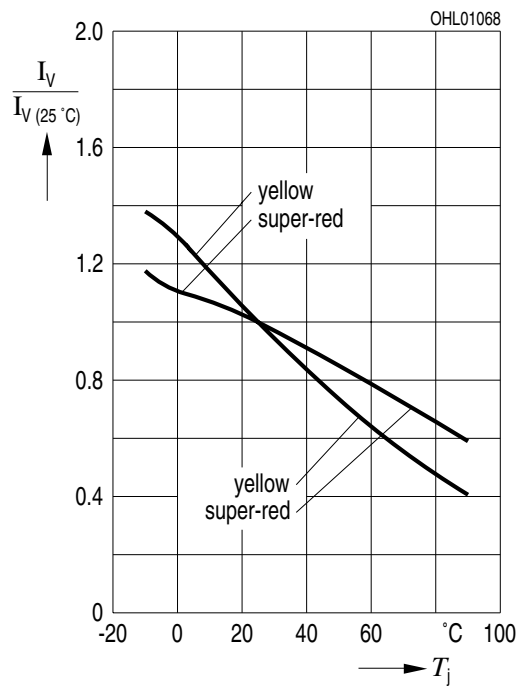

### Max. Permissible Forward Current

$I_F = f(T)$ ; • super red

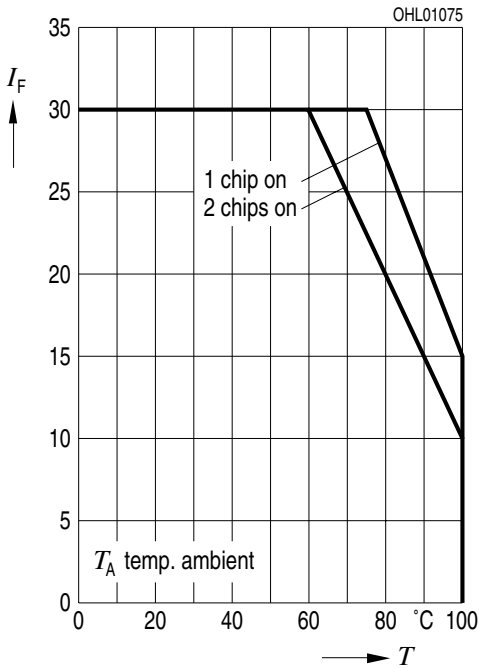

### Max. Permissible Forward Current

$I_F = f(T)$ ; • super red

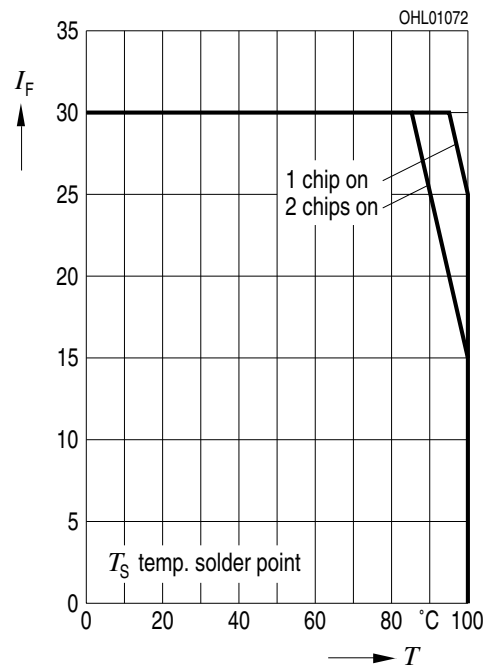

### Permissible Pulse Handling Capability

$I_F = f(t_p)$ ; D: Duty cycle;  $T_A = 25$  °C (Yellow)

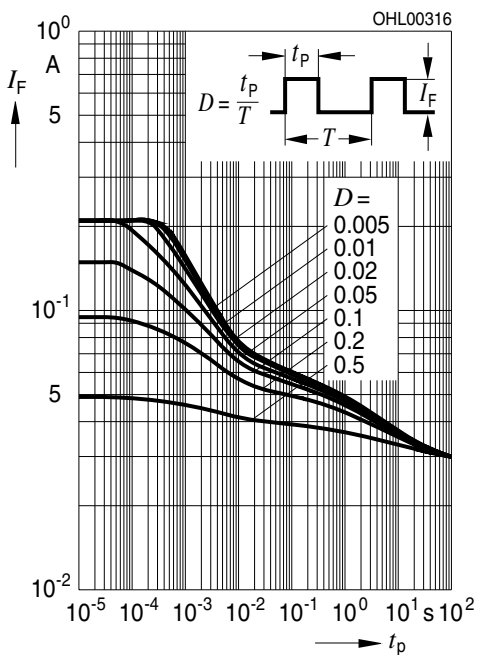

### Permissible Pulse Handling Capability

$I_F = f(t_p)$ ; D: Duty cycle;  $T_A = 25$  °C (Super red)

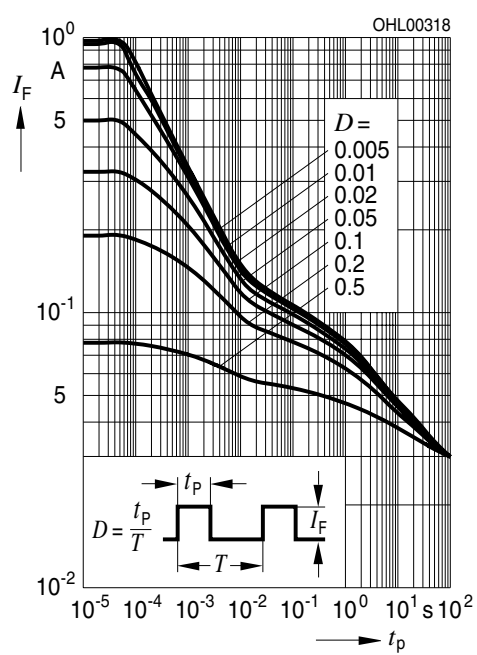

### Permissible Pulse Handling Capability

$I_F = f(t_p)$ ; D: Duty cycle;  $T_A = 85\text{ °C}$  (Super red)

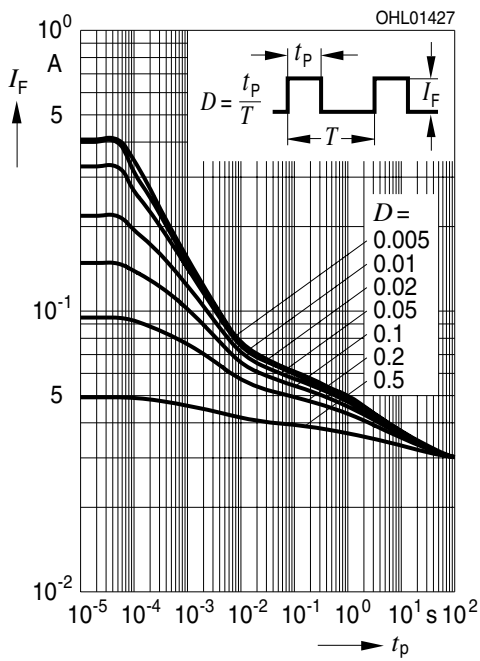

### Permissible Pulse Handling Capability

$I_F = f(t_p)$ ; D: Duty cycle;  $T_A = 85\text{ °C}$  (Yellow)

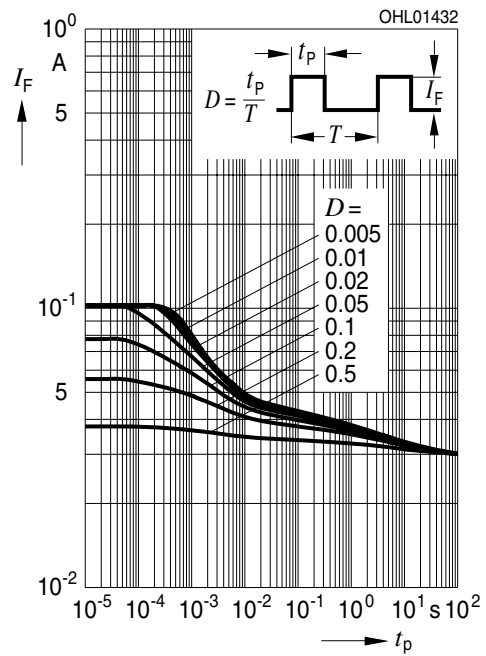

## Dimensional Drawing <sup>8)</sup>

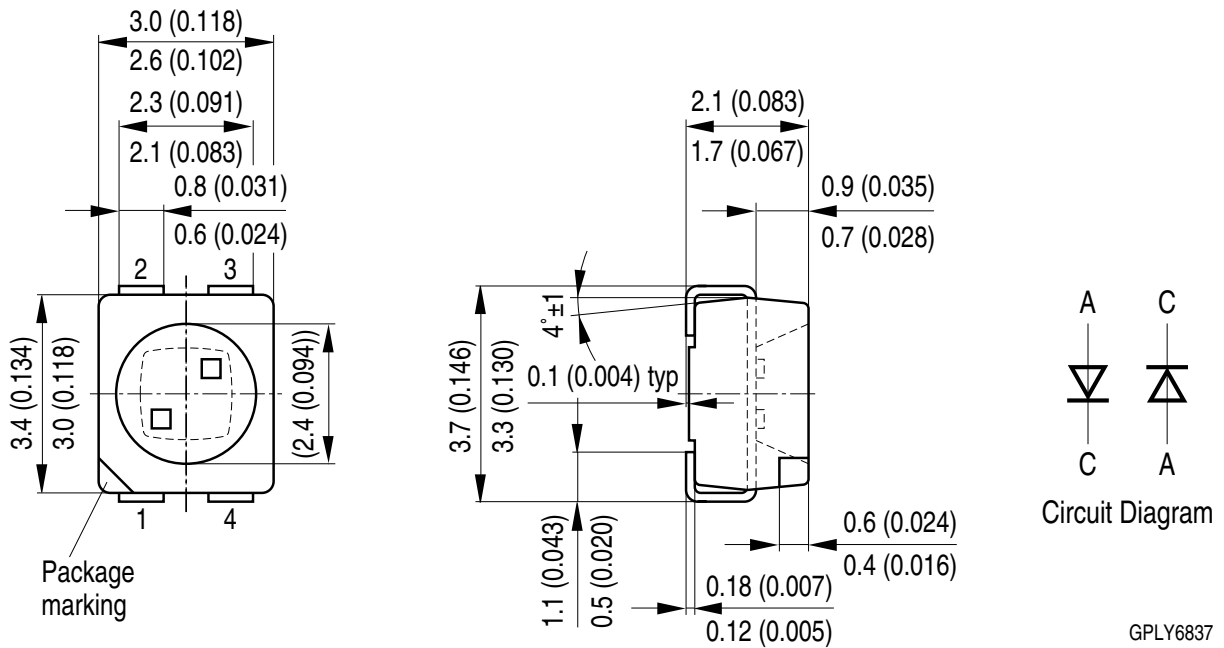

GPLY6837

## Further Information:

**Approximate Weight:** 31.0 mg

**Corrosion test:** Class: 3B  
 Test condition: 40°C / 90 % RH / 15 ppm H<sub>2</sub>S / 14 days (stricter than IEC 60068-2-43)

Pin	Description
Pin 1	Cathode Super Red
Pin 2	Anode Super Red
Pin 3	Cathode Yellow
Pin 4	Anode Yellow

**Recommended Solder Pad** <sup>8)</sup>

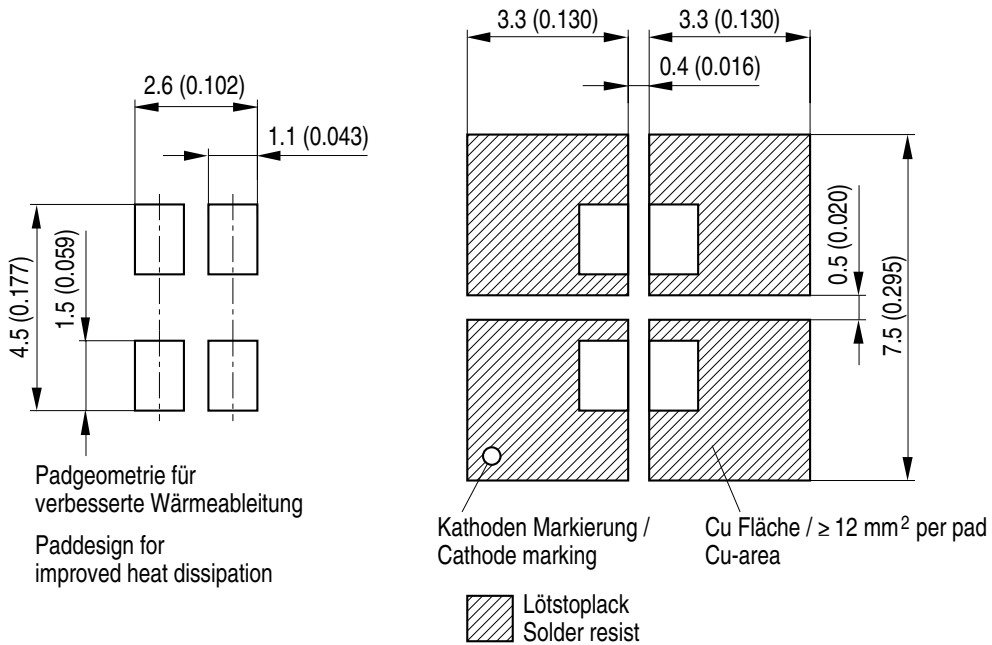

OHLPY439

For superior solder joint connectivity results we recommend soldering under standard nitrogen atmosphere. Package not suitable for ultra sonic cleaning.

## Reflow Soldering Profile

Product complies to MSL Level 2 acc. to JEDEC J-STD-020E



Profile Feature	Symbol	Pb-Free (SnAgCu) Assembly			Unit
		Minimum	Recommendation	Maximum	
Ramp-up rate to preheat <sup>*)</sup> 25 °C to 150 °C			2	3	K/s
Time $t_s$ $T_{Smin}$ to $T_{Smax}$	$t_s$	60	100	120	s
Ramp-up rate to peak <sup>*)</sup> $T_{Smax}$ to $T_p$			2	3	K/s
Liquidus temperature	$T_L$		217		°C
Time above liquidus temperature	$t_L$		80	100	s
Peak temperature	$T_p$		245	260	°C
Time within 5 °C of the specified peak temperature $T_p - 5$ K	$t_p$	10	20	30	s
Ramp-down rate* $T_p$ to 100 °C			3	6	K/s
Time 25 °C to $T_p$				480	s

All temperatures refer to the center of the package, measured on the top of the component

\* slope calculation  $DT/Dt$ :  $Dt$  max. 5 s; fulfillment for the whole T-range

Taping <sup>8)</sup>

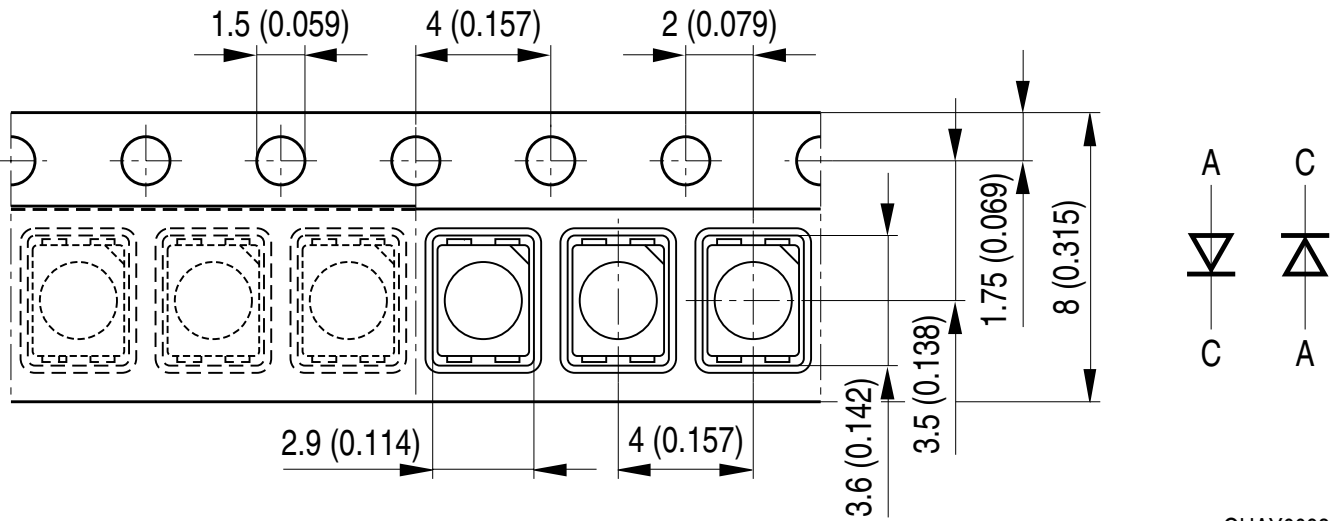

**Tape and Reel** <sup>9)</sup>



**Reel Dimensions**

A	W	$N_{\min}$	$W_1$	$W_{2\max}$	Pieces per PU
180 mm	8 + 0.3 / - 0.1 mm	60 mm	8.4 + 2 mm	14.4 mm	2000
330 mm	8 + 0.3 / - 0.1 mm	60 mm	8.4 + 2 mm	14.4 mm	8000



### Barcode-Product-Label (BPL)

**OSRAM Opto Semiconductors** LX XXXX BIN1: XX-XX-X-XXX-X

RoHS Compliant

(6P) BATCH NO: 1234567890 ML Temp ST  
X XXX °C X

(1T) LOT NO: 1234567890 (9D) D/C: 1234 Pack: RXX  
DEMY XXX  
X\_X123\_1234.1234 X

(X) PROD NO: 123456789(Q)QTY: 9999 (G) GROUP: XX-XX-X-X

The diagram shows a rectangular label with rounded corners. It contains the OSRAM logo and name, a part number 'LX XXXX', and a bin number 'BIN1: XX-XX-X-XXX-X'. It features three barcode types: a standard 1D barcode for batch number, a 1D barcode for lot number, and a 1D barcode for product number. A QR code is located on the right side. A 'No Moisture' symbol (a circle with a diagonal line and three drops) is placed above the QR code. Text fields include 'RoHS Compliant', 'ML Temp ST X XXX °C X', 'Pack: RXX', 'DEMY XXX', 'X\_X123\_1234.1234 X', and '(9D) D/C: 1234'. A large 'EXAMPLE' watermark is overlaid diagonally across the label.

OHA04563

### Dry Packing Process and Materials <sup>8)</sup>



OHA00539

Moisture-sensitive product is packed in a dry bag containing desiccant and a humidity card according JEDEC-STD-033.

## Type Designation System

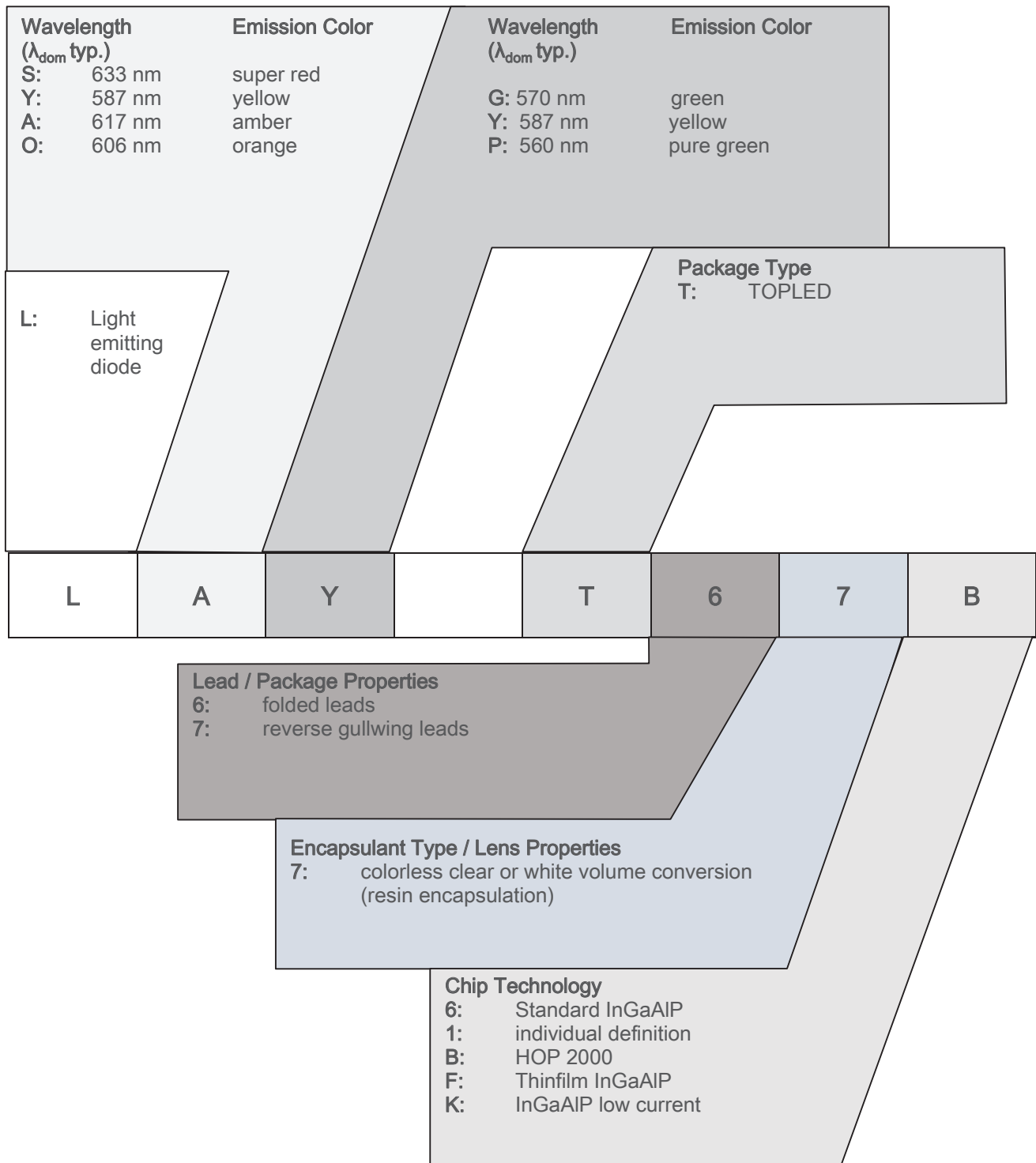

## Notes

The evaluation of eye safety occurs according to the standard IEC 62471:2006 (photo biological safety of lamps and lamp systems). Within the risk grouping system of this IEC standard, the device specified in this data sheet falls into the class **exempt group (exposure time 10000 s)**. Under real circumstances (for exposure time, conditions of the eye pupils, observation distance), it is assumed that no endangerment to the eye exists from these devices. As a matter of principle, however, it should be mentioned that intense light sources have a high secondary exposure potential due to their blinding effect. When looking at bright light sources (e.g. headlights), temporary reduction in visual acuity and afterimages can occur, leading to irritation, annoyance, visual impairment, and even accidents, depending on the situation.

Subcomponents of this device contain, in addition to other substances, metal filled materials including silver. Metal filled materials can be affected by environments that contain traces of aggressive substances. Therefore, we recommend that customers minimize device exposure to aggressive substances during storage, production, and use. Devices that showed visible discoloration when tested using the described tests above did show no performance deviations within failure limits during the stated test duration. Respective failure limits are described in the IEC60810.

For further application related information please visit [www.osram-os.com/appnotes](http://www.osram-os.com/appnotes)

## Disclaimer

### **Attention please!**

The information describes the type of component and shall not be considered as assured characteristics. Terms of delivery and rights to change design reserved. Due to technical requirements components may contain dangerous substances.

For information on the types in question please contact our Sales Organization.

If printed or downloaded, please find the latest version on the OSRAM OS website.

### **Packing**

Please use the recycling operators known to you. We can also help you – get in touch with your nearest sales office. By agreement we will take packing material back, if it is sorted. You must bear the costs of transport. For packing material that is returned to us unsorted or which we are not obliged to accept, we shall have to invoice you for any costs incurred.

### **Product and functional safety devices/applications or medical devices/applications**

OSRAM OS components are not developed, constructed or tested for the application as safety relevant component or for the application in medical devices.

OSRAM OS products are not qualified at module and system level for such application.

In case buyer – or customer supplied by buyer – considers using OSRAM OS components in product safety devices/applications or medical devices/applications, buyer and/or customer has to inform the local sales partner of OSRAM OS immediately and OSRAM OS and buyer and /or customer will analyze and coordinate the customer-specific request between OSRAM OS and buyer and/or customer.

---

## Glossary

- 1) **Brightness:** Brightness groups are tested at a current pulse duration of 25 ms and a tolerance of  $\pm 11\%$ .
- 2) **Reverse Operation:** This product is intended to be operated applying a forward current within the specified range. Applying any continuous reverse bias or forward bias below the voltage range of light emission shall be avoided because it may cause migration which can change the electro-optical characteristics or damage the LED.
- 3) **Wavelength:** Wavelengths are tested at a current pulse duration of 25 ms and a tolerance of  $\pm 1$  nm.
- 4) **Forward Voltage:** Forward voltages are tested at a current pulse duration of 1 ms and a tolerance of  $\pm 0.1$  V.
- 5) **Thermal Resistance:**  $R_{th\ max}$  is based on statistic values ( $6\sigma$ ).
- 6) **Typical Values:** Due to the special conditions of the manufacturing processes of semiconductor devices, the typical data or calculated correlations of technical parameters can only reflect statistical figures. These do not necessarily correspond to the actual parameters of each single product, which could differ from the typical data and calculated correlations or the typical characteristic line. If requested, e.g. because of technical improvements, these typ. data will be changed without any further notice.
- 7) **Characteristic curve:** In the range where the line of the graph is broken, you must expect higher differences between single devices within one packing unit.
- 8) **Tolerance of Measure:** Unless otherwise noted in drawing, tolerances are specified with  $\pm 0.1$  and dimensions are specified in mm.
- 9) **Tape and Reel:** All dimensions and tolerances are specified acc. IEC 60286-3 and specified in mm.

## Revision History

Version	Date	Change
1.1	2021-01-15	Features

---

Published by OSRAM Opto Semiconductors GmbH EU RoHS and China RoHS compliant product  
Leibnizstraße 4, D-93055 Regensburg  
www.osram-os.com © All Rights Reserved.



此产品符合欧盟 RoHS 指令的要求；  
按照中国的相关法规和标准，不含有毒有害物质或元素。