

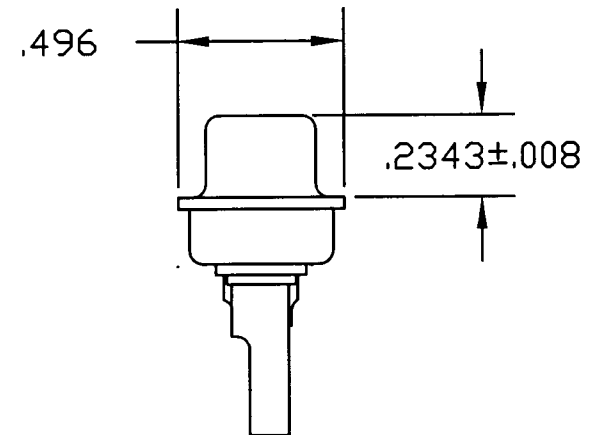
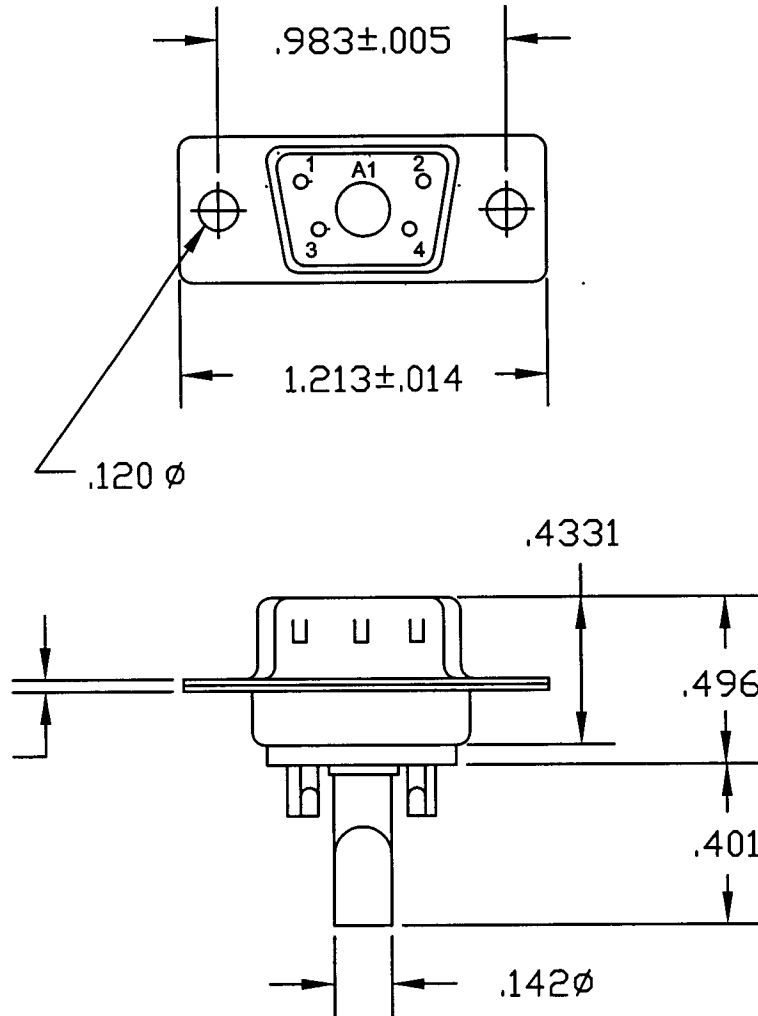

DESCRIPTION: 5W1 Male Connector - 20 Amp Contact

Specification:

Shell: Steel, Tin Plated
 Insulator: PBT +30% Fibre-Glass,
 Black, UL 94V-0
 Contacts: Brass - Gold Flash
 Over Nickel

Current Rating: Signal - 5 Amps
 Current Rating: Power - 20 Amps
 Contact Resistance: 15mΩHMS MAX.
 Insulator Resistance: 1000 MΩHMS MIN.
 Voltage: 500V AC for 1 minute
 Temperature: -50° C to +100°C



	THESE DRAWINGS AND SPECIFICATIONS ARE THE PROPERTY OF NorComp AND SHALL NOT BE REPRODUCED, COPIED OR USED AS THE BASIS FOR THE MANUFACTURE OF SALE OF APPARATUS WITHOUT WRITTEN PERMISSION.		DRAWN: PAM JENKINS	DATE: 3-30-01
			CHECKED:	DATE:
NorComp		SCALE:	SHEET 1 OF 1	REV 1
		DWG NO. 680-5W1-102-201		