

SERIES: SMM12 | **DESCRIPTION:** AC-DC POWER SUPPLY

FEATURES

- up to 12W continuous power
- universal input (90~264 Vac)
- interchangeable blades
- IEC 60601 certified
- MOPP
- black and white case options



MODEL	output voltage	output current max	output power max	ripple and noise ¹ max	efficiency level
	(Vdc)	(A)	(W)	(mVp-p)	
SMM12-5	5	2.4	12	100	VI
SMM12-9	9	1.33	12	135	VI
SMM12-12	12	1.0	12	180	VI
SMM12-15	15	0.8	12	225	VI
SMM12-18	18	0.66	12	270	VI
SMM12-24	24	0.5	12	240	VI

Notes: 1. At full load, 100~240 Vac input, 20 MHz bandwidth oscilloscope, output terminated with a 0.1 μF ceramic and a 47 μF electrolytic capacitor.

PART NUMBER KEY

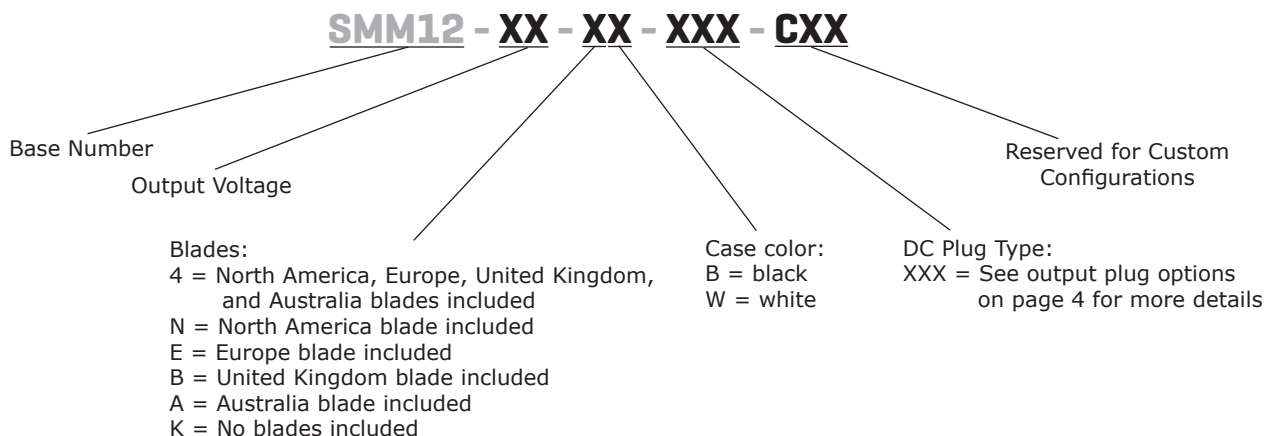

INPUT

parameter	conditions/description	min	typ	max	units
voltage		90		264	Vac
frequency		47		63	Hz
current	at 115 Vac, full load at 230 Vac, full load			1.0 0.5	A A
inrush current	at 115 Vac, cold start, full load at 230 Vac, cold start, full load			30 60	A A
leakage current	at 240 Vac, 50 Hz			0.1	mA
no load power consumption	at 115/230 Vac, 60/50 Hz			0.1	W

OUTPUT

parameter	conditions/description	min	typ	max	units
line regulation	at full load		±1		%
load regulation			±5		%
start-up time	at 100 Vac, output voltage rise to 90% of rated output voltage			3	s
rise time	at rated input, full load, from 10% to 90% of rated output voltage			50	ms
hold-up time	at nominal input, full load	8.3			ms

PROTECTIONS

parameter	conditions/description	min	typ	max	units
over voltage protection	output clamped with zener diode			150	%
over current protection	auto recovery			200	%
short circuit protection	continuous, auto recovery				

SAFETY & COMPLIANCE

parameter	conditions/description	min	typ	max	units
isolation voltage	input to output at 5 mA for 2 seconds		4,000		Vac
insulation resistance	input to output at 500 Vdc for 3 seconds	50			MΩ
safety approvals	60601: UL/cUL, TUV 60950: J				
EMI/EMC	FCC Part 15, Subpart B ICES-003 EN 55011 J5502				
MTBF	as per MIL-HDBK-217F at 25°C	100,000			hours
RoHS	yes				

ENVIRONMENTAL

parameter	conditions/description	min	typ	max	units
operating temperature		0		40	°C
storage temperature		-20		85	°C
operating humidity	non-condensing	10		90	%
storage humidity	non-condensing	5		90	%
altitude				5,000	m

MECHANICAL

parameter	conditions/description	min	typ	max	units
dimensions	57 (L) x 39 (W) x 34 (H)				mm
inlet plug	interchangeable blades (North America, Europe, UK, Australia)				
weight			70		g

MECHANICAL DRAWING

units: mm
tolerance: ±1 mm

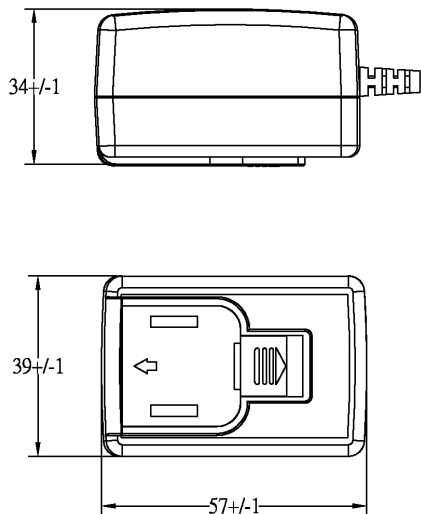

INTERCHANGEABLE BLADES				
BLADE DESIGNATOR	N	E	B	A
REGION	North America	Europe	UK	Australia
BLADE ACCESSORY BLACK CASE	SMI-US-5	SMI-EU-5	SMI-UK-5	SMI-AU-5
BLADE ACCESSORY WHITE CASE	SMI-US-5W	SMI-EU-5W	SMI-UK-5W	SMI-AU-5W
BLADE				

DC CORD

units: mm

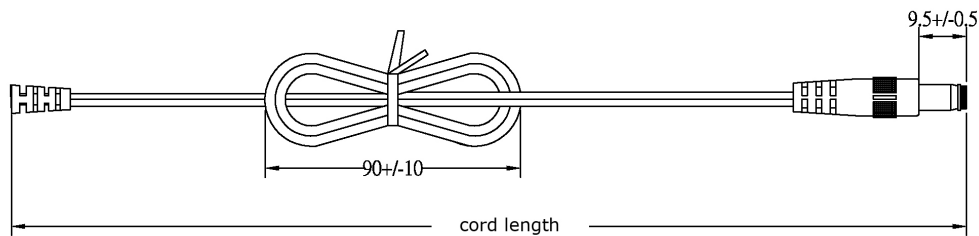
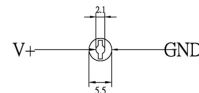

Table 1



MODEL NO.	CABLE	CORD LENGTH
SMM12-5	UL2468, 20 AWG	1,500 mm ±50
SMM12-9	UL2468, 20 AWG	1,500 mm ±50
SMM12-12	UL2468, 22 AWG	1,500 mm ±50
SMM12-15	UL2468, 22 AWG	1,500 mm ±50
SMM12-18	UL2468, 24 AWG	1,500 mm ±50
SMM12-24	UL2468, 24 AWG	1,500 mm ±50

DC PLUG TYPE PART NUMBER KEY

XXX

Plug Polarity:
P = Center Positive
N = Center Negative

Plug Code:
X = Choose a code from the options below

Plug Angle:
"blank" = Straight
R = Right Angle

Plug Polarity		Code		Dimensions (mm)			Plug Angle	
Center Pos.	Center Neg.	Option	Type	A	B	C	Straight	Right
•	•	5	Standard	5.5	2.1	9.5	•	•
•	•	6	Standard	5.5	2.5	9.5	•	•
•	•	7	Standard	3.5	1.35	9.5	•	•
•	•	10	Locking	5.5	2.1	9.5	•	N/A
•	•	11	Locking	5.5	2.5	9.5	•	N/A
•	•	12	EIAJ-1	2.35	0.7	9.5	•	•
•	•	13	EIAJ-2	4.0	1.7	9.5	•	•
•	•	14	EIAJ-3	4.75	1.7	9.5	•	•
N/A	N/A	CUB	USB	USB Type C			•	N/A
N/A	N/A	MUB	USB	Micro USB Type B			•	N/A

Note: 1. Contact CUI for additional plug options

Standard

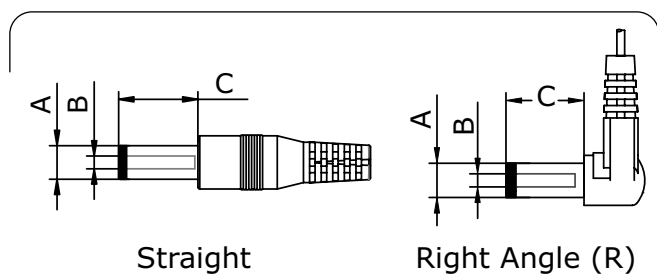

EIAJ

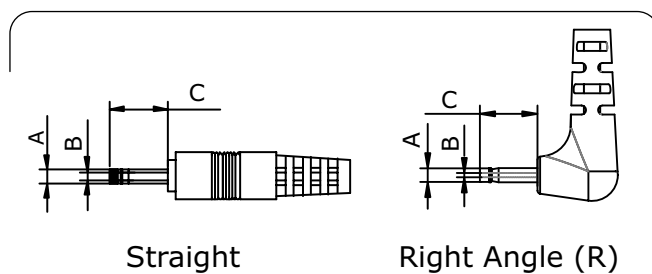

Locking

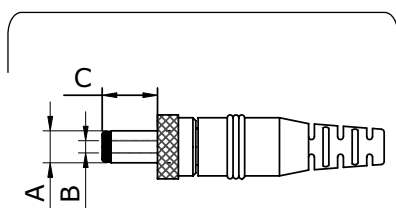

USB

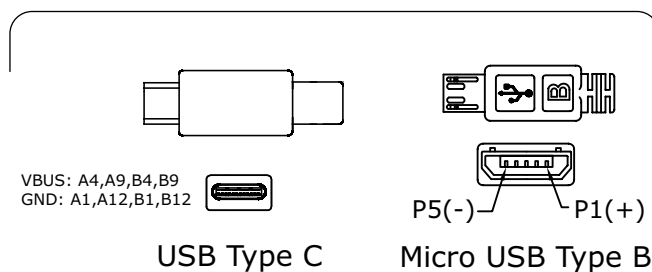

REVISION HISTORY

rev.	description	date
1.0	initial release	01/21/2021

The revision history provided is for informational purposes only and is believed to be accurate.



CUI INC

a bel group

Headquarters
20050 SW 112th Ave.
Tualatin, OR 97062
800.275.4899

Fax 503.612.2383
cui.com
techsupport@cui.com

This device complies with part 15 of the FCC Rules. Operation is subject to the following two conditions:

- (1) This device may not cause harmful interference, and
- (2) this device must accept any interference received, including interference that may cause undesired operation.

CUI offers a one (1) year limited warranty. Complete warranty information is listed on our website.

CUI reserves the right to make changes to the product at any time without notice. Information provided by CUI is believed to be accurate and reliable. However, no responsibility is assumed by CUI for its use, nor for any infringements of patents or other rights of third parties which may result from its use.

CUI products are not authorized or warranted for use as critical components in equipment that requires an extremely high level of reliability. A critical component is any component of a life support device or system whose failure to perform can be reasonably expected to cause the failure of the life support device or system, or to affect its safety or effectiveness.