

Tantalum Surface Mount Capacitors – High Reliability
T497 High Reliability Series (HRA)
MnO₂ (CWR09/19/29 Style)



Overview

The KEMET T497 is designed for the High Reliability Series (HRA) requirements of military, medical, and aerospace applications. This product is a HRA version of CWR09,19, and 29 products. The T497 Series is a surface mount product offering various lead-frame plating options, Weibull grading options, X-ray inspection, surge current testing, F-Tech (an improved anode manufacturing process) and Simulated Breakdown Voltage (SBDV) screening options to improve long term reliability.

KEMET's F-Tech eliminates hidden defects in the dielectric, which continue to grow in the field, causing capacitor failures. Based on the fundamental understanding of degradation mechanisms in tantalum and niobium capacitors, F-Tech incorporates multiple process methodologies. Some minimize the oxygen and carbon content in the anodes, which become contaminants and can lead to the crystallization of the anodic oxide dielectric. This process methodology reduces the contaminants, improving quality of the dielectric. An additional technology provides a stronger mechanical connection point between the tantalum lead wire and tantalum anode, enhancing robustness and product reliability. The benefit of F-Tech is illustrated by a 2,000 hour, 85°C, 1.32 X rated voltage accelerated life test. The F-Tech parts see no degradation while standard tantalums have 1.5 orders of magnitude degradation in leakage current. F-Tech is currently available for T493 (select D and X case capacitance values in 25 V and higher rated voltage), and T497 (select H case capacitance values in 25 V and higher rated voltage). Please contact KEMET for details on ordering other part types with these capabilities.

KEMET's patented Simulated Breakdown Screening (SBDS) is a nondestructive testing technique that simulates the breakdown voltage (BDV) of a capacitor without damage to its dielectric or to the general population of capacitors. This screening identifies hidden defects in the dielectric, providing the highest level of dielectric testing. SBDS is based on the simulation of breakdown voltage (BDV), the ultimate test of the dielectric in a capacitor.

Low BDV indicates defects in the dielectric, and therefore, a higher probability of failure in the field. High BDV indicates a stronger dielectric and high-reliability performance in the field. This new screening method allows KEMET to identify the breakdown voltage of each individual capacitor and provides only the strongest capacitors from each lot.

SBDS is currently available on select part types in the T493 and T497 series. Please contact KEMET for details on ordering other part types with these capabilities.

KEMET offers these technologies per the following options:

- F-Tech only
- SBDS only
- Combination of both F-Tech and SBDS for the ultimate protection



Benefits

- F-Tech and Simulated Breakdown Voltage (SBDS) screening options available
- Tape & Reel standard packaging per EIA 481
- Symmetrical, compliant terminations
- Laser-marked case
- 100% surge current test available on all case sizes
- Termination options B, H, and T
- Weibull failure options B and C
- 100% thermal shock

Applications

Typical applications include decoupling and filtering in military, medical, and aerospace applications.

Environmental Compliance

RoHS compliant when ordered with 100% Sn solder.

- Halogen-free
- Epoxy compliant with UL94 V-0
- Molded Epoxy complies for outgassing testing under ASTM E 595.

K-SIM

For a detailed analysis of specific part numbers, please visit ksim.kemet.com to access KEMET's K-SIM software. KEMET K-SIM is designed to simulate behavior of components with respect to frequency, ambient temperature, and DC bias levels.

Ordering Information

T	497	G	226	K	020	A	H	61	10	
Capacitor Class	Series	Case Size	Capacitance Code (pF)	Capacitance Tolerance	Rated Voltage (VDC)	Failure Rate/Design	Termination Finish	Surge	X-ray	Packaging (C-Spec)
T = Tantalum	High Grade	A B C D E F G H X	First two digits represent significant figures. Third digit specifies number of zeros.	K = ±10% M = ±20%	004 = 4 006 = 6.3 010 = 10 016 = 16 020 = 20 025 = 25 035 = 35 050 = 50	A = N/A B = 0.1%/1,000 hours C = 0.01%/1,000 hours	T = 100% Matte Tin (Sn)-plated H = Standard solder-coated (SnPb 5% Pb minimum) B = Gold-plated C = Hot solder dipped K = Solder fused	61 = Standard (in-process) 62 = 10 Cycles after Weibull, 25°C 63 = 10 Cycles after Weibull, -55° and 85°C 64 = 10 Cycles before Weibull, -55° and 85°C	10 = None 15 = 100%	Blank = 7" Reel 7280 = 13" Reel 7610 = Bulk bag 7640 = Bulk plastic box WAF = Waffle pack

Ordering Information – F-Tech & Simulated Breakdown Screening (SBDS)

T	497	H	226	K	020	A	H	61	10
Capacitor Class	Series	Case Size	Capacitance Code (pF)	Capacitance Tolerance	Rated Voltage (VDC)	Failure Rate/Design	Termination Finish	Surge	Design/Screening
T = Tantalum	High Grade	H	First two digits represent significant figures. Third digit specifies number of zeros.	K = ±10% M = ±20%	025 = 25 035 = 35 050 = 50	A = N/A B = 0.1%/1,000 hours C = 0.01%/1,000 hours	T = 100% Matte Tin (Sn)-plated H = Standard solder-coated (SnPb 5% Pb minimum) B = Gold-plated C = Hot solder dipped K = Solder fused	61 = Standard (in-process) 62 = 10 Cycles after Weibull, 25°C 63 = 10 Cycles after Weibull, -55° and 85°C 64 = 10 Cycles before Weibull, -55° and 85°C	10 = Standard 11 = F-Tech & SBDS 12 = SBDS 13 = F-Tech 15 = 100% X-ray 16 = F-Tech & SBDS & 100% X-ray 17 = SBDS & 100% X-ray 18 = F-Tech & 100% X-ray

Performance Characteristics

Item	Performance Characteristics
Operating Temperature	-55°C to 125°C
Rated Capacitance Range	0.1 – 150 µF at 120 Hz/25°C
Capacitance Tolerance	K Tolerance (10%), M Tolerance (20%)
Rated Voltage Range	4 – 50 V
DF (120 Hz)	Refer to Part Number Electrical Specification Table
ESR (100 kHz)	Refer to Part Number Electrical Specification Table
Leakage Current	≤ 0.01 CV (µA) at rated voltage after 5 minutes

Qualification

Test	Condition	Characteristics				
Endurance	105°C at rated voltage, 2,000 hours 125°C at 2/3 rated voltage, 2,000 hours	Δ C/C	Within -20%/+10% of initial value			
		DF	≤ Initial Limit			
		DCL	2 x IL at 125°C			
		ESR	2 x Initial Limit			
Storage Life	125°C at 0 volts, 2,000 hours	Δ C/C	Within -20%/+10% of initial value			
		DF	Within initial limits			
		DCL	Within 2.0 x initial limit			
		ESR	Within 2.0 x initial limit			
Humidity	85°C, 85% RH, 1,000 hours No Load	Δ C/C	Within -5%/+35% of initial value			
		DF	≤ Initial Limit			
		DCL	Within 3.0 x initial limit			
Temperature Stability	Extreme temperature exposure at a succession of continuous steps at +25°C, -55°C, +25°C, +85°C, +125°C, +25°C	+25°C	-55°C	+85°C	+125°C	
		Δ C/C	IL*	±20%	±20%	±30%
		DF	IL	IL	1.2 x IL	1.5 x IL
Surge Voltage	105°C, 1.32 x rated voltage 1,000 cycles	DCL	IL			
		ESR	n/a			
		10 x IL	10 x IL		10 x IL	
		10 x IL	10 x IL		10 x IL	
Mechanical Shock/ Vibration	MIL-STD-202, Method 213, Condition I, 100 G peak MIL-STD-202, Method 204, Condition D, 10 Hz to 2,000 Hz, 20 G peak	Δ C/C	Within ±10% of initial value			
		DF	Within initial limits			
		DCL	Within initial limits			

*IL = Initial limit

Electrical Characteristics

ESR vs. Frequency

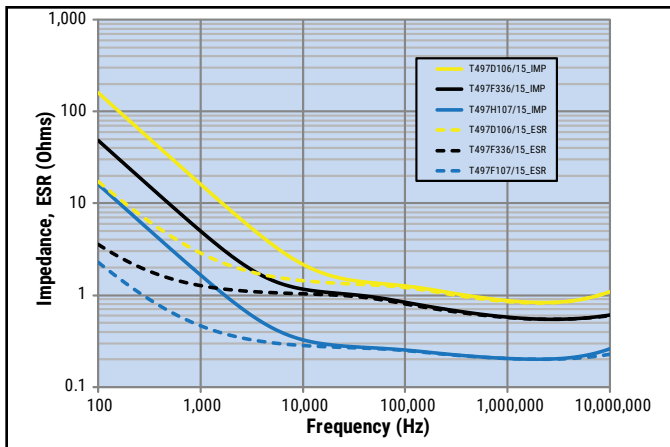

Capacitance vs. Frequency

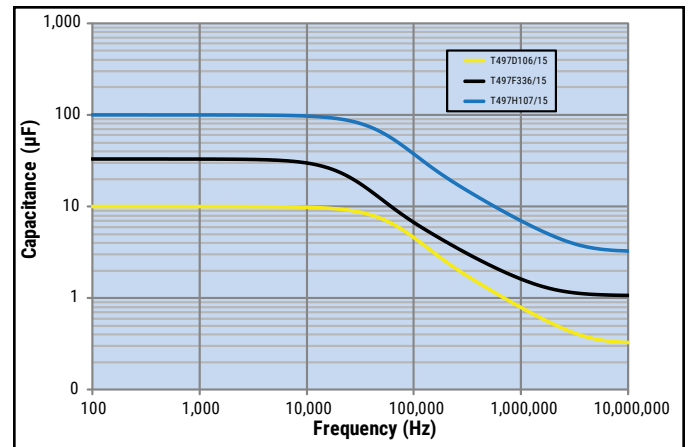

Dimensions – Millimeters (Inches)

Metric will govern

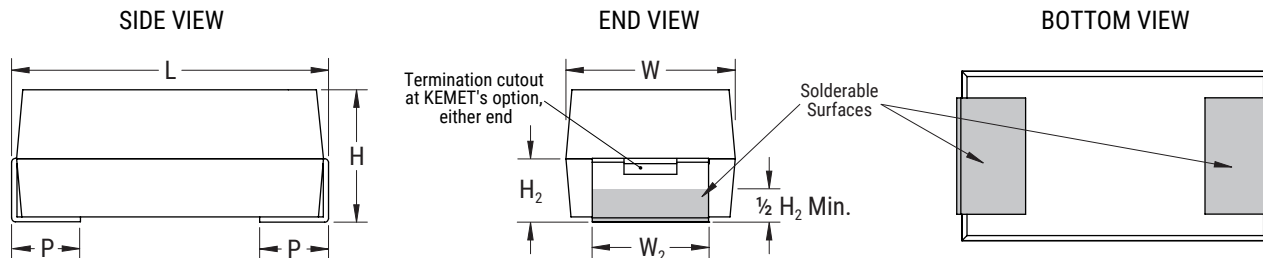

Case Size	Component						Typical Weight
KEMET	L ±0.38 (0.015)	W ±0.38 (0.015)	H ±0.38 (0.015)	P +0.25 (0.010), -0.13 (0.005)	W ₂	H ₂ Minimum	(mg)
A	2.54 (0.100)	1.27 (0.050)	1.27 (0.050)	0.76 (0.030)	1.27±0.13 (0.050±0.005)	0.76 (0.030)	39.91
B	3.81 (0.150)	1.27 (0.050)	1.27 (0.050)	0.76 (0.030)	1.27±0.13 (0.050±0.005)	0.76 (0.030)	68.73
C	5.08 (0.200)	1.27 (0.050)	1.27 (0.050)	0.76 (0.030)	1.27±0.13 (0.050±0.005)	0.76 (0.030)	146.5
D	3.81 (0.150)	2.54 (0.100)	1.27 (0.050)	0.76 (0.030)	2.41+0.13,-0.25 (0.095+0.005,-0.010)	0.76 (0.030)	264.12
E	5.08 (0.200)	2.54 (0.100)	1.27 (0.050)	0.76 (0.030)	2.41+0.13,-0.25 (0.095+0.005,-0.010)	0.76 (0.030)	421.63
F	5.59 (0.220)	3.43 (0.135)	1.78 (0.070)	0.76 (0.030)	3.30±0.13 (0.130±0.005)	1.02 (0.040)	173.63
G	6.73 (0.265)	2.79 (0.110)	2.79 (0.110)	1.27 (0.050)	2.67±0.13 (0.105±0.005)	1.52 (0.060)	266.42
H	7.24 (0.285)	3.81 (0.150)	2.79 (0.110)	1.27 (0.050)	3.68+0.013,-0.51 (0.145+0.005,-0.020)	1.52 (0.060)	349.01
X	6.93 (0.273)	5.41 (0.213)	2.74 (0.108)	1.19 (0.047)	3.05±0.13 (0.120±0.005)	1.22 (0.048)	590.44

Note: When solder coated terminations are required, add an additional 0.38 mm (0.015 inch) to the above tolerances for "L", "W", "H", "P", "W₂" and "H₂". These weights are provided as reference. If exact weights are needed, please contact your KEMET Sales Representative

Table 1 – Ratings & Part Number Reference

Rated Voltage	Rated Cap	Case Code/ Case Size	KEMET Part Number	DC Leakage	DF	ESR	Ripple Current (mArms)	Maximum Operating Temp	MSL
VDC at 85°C	µF	KEMET/EIA	(See below for part options)	µA at +25°C Maximum/5 Min.	% at 25°C 120 Hz Maximum	Ω at +25°C 100 kHz Maximum	100kHz, 25 °C	°C	Reflow Temp. ≤ 260°C
4	4.7	A/1005	T497A475(1)004(2)(3)(4)(5)	0.2	6.0	12.0	65	125	1.0
4	4.7	B/1505	T497B475(1)004(2)(3)(4)(5)	0.2	6.0	8.0	94	125	1.0
4	15	B/1505	T497B156(1)004(2)(3)(4)(5)	0.6	8.0	8.0	94	125	1.0
4	33	D/1510	T497D336(1)004(2)(3)(4)(5)	1.3	8.0	4.0	141	125	1.0
4	33	F/2214	T497F336(1)004(2)(3)(4)(5)	1.3	8.0	2.2	213	125	1.0
4	68	E/2010	T497E686(1)004(2)(3)(4)(5)	2.7	8.0	3.0	173	125	1.0
4	68	F/2214	T497F686(1)004(2)(3)(4)(5)	2.7	6.0	2.0	224	125	1.0
4	68	G/2711	T497G686(1)004(2)(3)(4)(5)	2.7	10.0	1.1	337	125	1.0
4	100	H/2915	T497H107(1)004(2)(3)(4)(5)	4.0	10.0	0.9	408	125	1.0
6.3	1.5	A/1005	T497A155(1)006(2)(3)(4)(5)	0.1	6.0	8.0	79	125	1.0
6.3	2.2	A/1005	T497A225(1)006(2)(3)(4)(5)	0.1	6.0	10.0	71	125	1.0
6.3	3.3	A/1005	T497A335(1)006(2)(3)(4)(5)	0.2	6.0	12.0	65	125	1.0
6.3	3.3	B/1505	T497B335(1)006(2)(3)(4)(5)	0.2	6.0	8.0	94	125	1.0
6.3	4.7	A/1005	T497A475(1)006(2)(3)(4)(5)	0.3	6.0	12.0	65	125	1.0
6.3	4.7	D/1510	T497D475(1)006(2)(3)(4)(5)	0.3	6.0	5.5	121	125	1.0
6.3	6.8	B/1505	T497B685(1)006(2)(3)(4)(5)	0.4	6.0	8.0	94	125	1.0
6.3	6.8	D/1510	T497D685(1)006(2)(3)(4)(5)	0.4	6.0	4.5	133	125	1.0
6.3	10	B/1505	T497B106(1)006(2)(3)(4)(5)	0.6	6.0	8.0	94	125	1.0
6.3	10	E/2010	T497E106(1)006(2)(3)(4)(5)	0.6	8.0	3.5	160	125	1.0
6.3	15	B/1505	T497B156(1)006(2)(3)(4)(5)	0.9	8.0	8.0	94	125	1.0
6.3	15	D/1510	T497D156(1)006(2)(3)(4)(5)	0.9	8.0	5.0	126	125	1.0
6.3	22	D/1510	T497D226(1)006(2)(3)(4)(5)	1.4	6.0	5.0	126	125	1.0
6.3	22	E/2010	T497E226(1)006(2)(3)(4)(5)	1.4	8.0	3.5	160	125	1.0
6.3	22	F/2214	T497F226(1)006(2)(3)(4)(5)	1.4	8.0	2.2	213	125	1.0
6.3	33	E/2010	T497E336(1)006(2)(3)(4)(5)	2.1	6.0	3.5	160	125	1.0
6.3	47	F/2214	T497F476(1)006(2)(3)(4)(5)	3.0	8.0	3.5	169	125	1.0
6.3	47	G/2711	T497G476(1)006(2)(3)(4)(5)	3.0	10.0	1.1	337	125	1.0
6.3	68	F/2214	T497F686(1)006(2)(3)(4)(5)	4.3	10.0	1.5	258	125	1.0
6.3	68	H/2915	T497H686(1)006(2)(3)(4)(5)	4.3	10.0	0.9	408	125	1.0
6.3	100	G/2711	T497G107(1)006(2)(3)(4)(5)	6.3	10.0	1.1	337	125	1.0
6.3	150	G/2711	T497G157(1)006(2)(3)(4)(5)	9.5	10.0	1.1	337	125	1.0
6.3	150	H/2915	T497H157(1)006(2)(3)(4)(5)	9.5	10.0	0.9	408	125	1.0
10	0.47	A/1005	T497A474(1)010(2)(3)(4)(5)	0.0	6.0	10.0	71	125	1.0
10	1	A/1005	T497A105(1)010(2)(3)(4)(5)	0.1	6.0	10.0	71	125	1.0
10	1.5	A/1005	T497A155(1)010(2)(3)(4)(5)	0.2	6.0	10.0	71	125	1.0
10	2.2	A/1005	T497A225(1)010(2)(3)(4)(5)	0.2	6.0	12.0	65	125	1.0
10	2.2	B/1505	T497B225(1)010(2)(3)(4)(5)	0.2	6.0	8.0	94	125	1.0
10	3.3	A/1005	T497A335(1)010(2)(3)(4)(5)	0.3	6.0	12.0	65	125	1.0
VDC at 85°C	µF	KEMET/EIA	(See below for part options)	µA at +25°C Maximum/5 Min.	% at 25°C 120 Hz Maximum	Ω at +25°C 100 kHz Maximum	100kHz, 25 °C	°C	Reflow Temp. ≤ 260°C
Rated Voltage	Rated Cap	Case Code/ Case Size	KEMET Part Number	DC Leakage	DF	ESR	Ripple Current (mArms)	Maximum Operating Temp	MSL

- (1) To complete KEMET part number, insert M for ±20% or K for ±10%. Designates Capacitance tolerance.
 (2) To complete KEMET part number, insert B (0.1%/1,000 hours), C (0.01%/1,000 hours) or A = N/A. Designates Reliability Level.
 (3) To complete KEMET part number, insert T = 100% Matte Tin (Sn)-plated, B = Gold-plated, H = Standard Solder coated (SnPb 5% Pb minimum), C = Hot Solder Dipped, K = Solder Fused. Designates Termination Finish.
 (4) To complete KEMET part number, insert 61 = Standard (in-process), 62 = 10 Cycles after Weibull, +25°C, 63 = 10 Cycles after Weibull, -55° and +85°C or 64 = 10 cycles before Weibull, -55°C and +85°C.
 (5) To complete KEMET part number, insert 10 = None or 15 = 100%. Designates X-ray inspection.
 (6) To complete KEMET part number, insert 10 = Standard, 11 = F-Tech & SBDS, 12 = SBDS, 13 = F-Tech, 15 = 100% X-ray, 16 = F-Tech & SBDS, & 100% X-ray, 17 = SBDS & 100%, X-ray, 18 = F-Tech & 100%X-ray. Designates screening.
 Designates Termination Finish.
 Refer to Ordering Information for additional detail.
 Higher voltage ratings and tighter tolerance product including ESR may be substituted within the same size at KEMET's option. Voltage substitution will be marked with the higher voltage rating. Substitutions can include better than series.

Table 1 – Ratings & Part Number Reference cont.

Rated Voltage	Rated Cap	Case Code/ Case Size	KEMET Part Number	DC Leakage	DF	ESR	Ripple Current (mArms)	Maximum Operating Temp	MSL
VDC at 85°C	µF	KEMET/EIA	(See below for part options)	µA at +25°C Maximum/5 Min.	% at 25°C 120 Hz Maximum	Ω at +25°C 100 kHz Maximum	100kHz, 25 °C	°C	Reflow Temp. ≤ 260°C
10	3.3	B/1505	T497B335(1)010(2)(3)(4)(5)	0.3	6.0	10.0	71	125	1.0
10	4.7	B/1505	T497B475(1)010(2)(3)(4)(5)	0.5	6.0	8.0	94	125	1.0
10	4.7	D/1510	T497D475(1)010(2)(3)(4)(5)	0.5	6.0	4.5	133	125	1.0
10	6.8	B/1505	T497B685(1)010(2)(3)(4)(5)	0.7	6.0	8.0	94	125	1.0
10	6.8	F/2214	T497F685(1)010(2)(3)(4)(5)	0.7	6.0	5.0	141	125	1.0
10	6.8	E/2010	T497E685(1)010(2)(3)(4)(5)	0.7	6.0	3.5	160	125	1.0
10	10	B/1505	T497B106(1)010(2)(3)(4)(5)	1.0	8.0	8.0	94	125	1.0
10	10	D/1510	T497D106(1)010(2)(3)(4)(5)	1.0	6.0	4.0	141	125	1.0
10	10	E/2010	T497E106(1)010(2)(3)(4)(5)	1.0	6.0	3.5	160	125	1.0
10	15	D/1510	T497D156(1)010(2)(3)(4)(5)	1.5	6.0	5.0	126	125	1.0
10	15	E/2010	T497E156(1)010(2)(3)(4)(5)	1.5	8.0	3.0	173	125	1.0
10	15	F/2214	T497F156(1)010(2)(3)(4)(5)	1.5	8.0	2.5	200	125	1.0
10	22	D/1510	T497D226(1)010(2)(3)(4)(5)	2.2	6.0	4.0	141	125	1.0
10	22	E/2010	T497E226(1)010(2)(3)(4)(5)	2.2	8.0	2.0	212	125	1.0
10	22	F/2214	T497F226(1)010(2)(3)(4)(5)	2.2	8.0	1.5	258	125	1.0
10	22	G/2711	T497G226(1)010(2)(3)(4)(5)	2.2	8.0	1.5	289	125	1.0
10	33	F/2214	T497F336(1)010(2)(3)(4)(5)	3.3	8.0	1.5	258	125	1.0
10	33	G/2711	T497G336(1)010(2)(3)(4)(5)	3.3	10.0	1.5	289	125	1.0
10	47	F/2214	T497F476(1)010(2)(3)(4)(5)	4.7	10.0	1.5	258	125	1.0
10	47	G/2711	T497G476(1)010(2)(3)(4)(5)	4.7	10.0	1.0	354	125	1.0
10	47	H/2915	T497H476(1)010(2)(3)(4)(5)	4.7	10.0	0.9	408	125	1.0
10	68	G/2711	T497G686(1)010(2)(3)(4)(5)	6.8	10.0	1.1	337	125	1.0
10	100	G/2711	T497G107(1)010(2)(3)(4)(5)	10.0	10.0	1.1	337	125	1.0
10	100	H/2915	T497H107(1)010(2)(3)(4)(5)	10.0	10.0	0.9	408	125	1.0
10	150	H/2915	T497H157(1)010(2)(3)(4)(5)	15.0	10.0	0.9	408	125	1.0
15	0.1	A/1005	T497A104(1)015(2)(3)(4)(5)	0.0	6.0	15.0	58	125	1.0
15	0.22	A/1005	T497A224(1)015(2)(3)(4)(5)	0.0	6.0	15.0	58	125	1.0
15	0.33	A/1005	T497A334(1)015(2)(3)(4)(5)	0.0	6.0	15.0	58	125	1.0
15	0.68	A/1005	T497A684(1)015(2)(3)(4)(5)	0.1	6.0	20.0	50	125	1.0
15	1	A/1005	T497A105(1)015(2)(3)(4)(5)	0.2	6.0	15.0	58	125	1.0
15	1.5	A/1005	T497A155(1)015(2)(3)(4)(5)	0.2	6.0	15.0	58	125	1.0
15	1.5	B/1505	T497B155(1)015(2)(3)(4)(5)	0.2	6.0	8.0	94	125	1.0
15	2.2	A/1005	T497A225(1)015(2)(3)(4)(5)	0.3	6.0	15.0	58	125	1.0
15	3.3	B/1505	T497B335(1)015(2)(3)(4)(5)	0.5	6.0	9.0	75	125	1.0
15	3.3	D/1510	T497D335(1)015(2)(3)(4)(5)	0.5	6.0	5.0	126	125	1.0
15	4.7	B/1505	T497B475(1)015(2)(3)(4)(5)	0.7	6.0	5.0	100	125	1.0
15	4.7	D/1510	T497D475(1)015(2)(3)(4)(5)	0.7	6.0	6.0	115	125	1.0
15	4.7	E/2010	T497E475(1)015(2)(3)(4)(5)	0.7	6.0	4.0	150	125	1.0
VDC at 85°C	µF	KEMET/EIA	(See below for part options)	µA at +25°C Maximum/5 Min.	% at 25°C 120 Hz Maximum	Ω at +25°C 100 kHz Maximum	100kHz, 25 °C	°C	Reflow Temp. ≤ 260°C
Rated Voltage	Rated Cap	Case Code/ Case Size	KEMET Part Number	DC Leakage	DF	ESR	Ripple Current (mArms)	Maximum Operating Temp	MSL

(1) To complete KEMET part number, insert M for ±20% or K for ±10%. Designates Capacitance tolerance.
 (2) To complete KEMET part number, insert B (0.1%/1,000 hours), C (0.01%/1,000 hours) or A = N/A. Designates Reliability Level.
 (3) To complete KEMET part number, insert T = 100% Matte Tin (Sn)-plated, B = Gold-plated, H = Standard Solder coated (SnPb 5% Pb minimum), C = Hot Solder Dipped, K = Solder Fused. Designates Termination Finish.
 (4) To complete KEMET part number, insert 61 = Standard (in-process), 62 = 10 Cycles after Weibull, +25°C, 63 = 10 Cycles after Weibull, -55° and +85°C or 64 = 10 cycles before Weibull, -55°C and +85°C.
 (5) To complete KEMET part number, insert 10 = None or 15 = 100%. Designates X-ray inspection.
 (6) To complete KEMET part number, insert 10 = Standard, 11 = F-Tech & SBDS, 12 = SBDS, 13 = F-Tech, 15 = 100% X-ray, 16 = F-Tech & SBDS, & 100% X-ray, 17 = SBDS & 100%, X-ray, 18 = F-Tech & 100%X-ray. Designates screening.
 Designates Termination Finish.
 Refer to Ordering Information for additional detail.
 Higher voltage ratings and tighter tolerance product including ESR may be substituted within the same size at KEMET's option. Voltage substitution will be marked with the higher voltage rating. Substitutions can include better than series.

Table 1 – Ratings & Part Number Reference cont.

Rated Voltage	Rated Cap	Case Code/ Case Size	KEMET Part Number	DC Leakage	DF	ESR	Ripple Current (mArms)	Maximum Operating Temp	MSL
VDC at 85°C	µF	KEMET/EIA	(See below for part options)	µA at +25°C Maximum/5 Min.	% at 25°C 120 Hz Maximum	Ω at +25°C 100 kHz Maximum	100kHz, 25 °C	°C	Reflow Temp. ≤ 260°C
15	6.8	D/1510	T497D685(1)015(2)(3)(4)(5)	1.0	6.0	6.0	115	125	1.0
15	10	D/1510	T497D106(1)015(2)(3)(4)(5)	1.5	6.0	6.0	115	125	1.0
15	10	E/2010	T497E106(1)015(2)(3)(4)(5)	1.5	6.0	4.0	150	125	1.0
15	10	F/2214	T497F106(1)015(2)(3)(4)(5)	1.5	6.0	2.5	200	125	1.0
15	15	E/2010	T497E156(1)015(2)(3)(4)(5)	2.3	6.0	4.0	150	125	1.0
15	15	F/2214	T497F156(1)015(2)(3)(4)(5)	2.3	6.0	2.5	200	125	1.0
15	22	F/2214	T497F226(1)015(2)(3)(4)(5)	3.3	8.0	3.0	183	125	1.0
15	22	G/2711	T497G226(1)015(2)(3)(4)(5)	3.3	6.0	1.1	337	125	1.0
15	33	F/2214	T497F336(1)015(2)(3)(4)(5)	5.0	6.0	3.0	183	125	1.0
15	33	H/2915	T497H336(1)015(2)(3)(4)(5)	5.0	8.0	0.9	408	125	1.0
15	47	G/2711	T497G476(1)015(2)(3)(4)(5)	7.1	8.0	1.1	337	125	1.0
15	68	H/2915	T497H686(1)015(2)(3)(4)(5)	10.2	8.0	0.9	408	125	1.0
15	100	H/2915	T497H107(1)015(2)(3)(4)(5)	15.0	10.0	0.9	408	125	1.0
20	0.15	A/1005	T497A154(1)020(2)(3)(4)(5)	0.0	8.0	15.0	58	125	1.0
20	0.47	A/1005	T497A474(1)020(2)(3)(4)(5)	0.1	8.0	14.0	60	125	1.0
20	0.68	A/1005	T497A684(1)020(2)(3)(4)(5)	0.1	6.0	15.0	58	125	1.0
20	0.68	B/1505	T497B684(1)020(2)(3)(4)(5)	0.1	6.0	10.0	71	125	1.0
20	1	A/1005	T497A105(1)020(2)(3)(4)(5)	0.2	6.0	15.0	58	125	1.0
20	1	B/1505	T497B105(1)020(2)(3)(4)(5)	0.2	6.0	12.0	65	125	1.0
20	1.5	B/1505	T497B155(1)020(2)(3)(4)(5)	0.3	6.0	9.0	75	125	1.0
20	2.2	B/1505	T497B225(1)020(2)(3)(4)(5)	0.4	6.0	9.0	75	125	1.0
20	2.2	D/1510	T497D225(1)020(2)(3)(4)(5)	0.4	6.0	5.0	126	125	1.0
20	3.3	D/1510	T497D335(1)020(2)(3)(4)(5)	0.7	6.0	6.0	115	125	1.0
20	3.3	E/2010	T497E335(1)020(2)(3)(4)(5)	0.7	6.0	4.0	150	125	1.0
20	4.7	E/2010	T497E475(1)020(2)(3)(4)(5)	0.9	6.0	6.0	122	125	1.0
20	4.7	F/2214	T497F475(1)020(2)(3)(4)(5)	0.9	6.0	4.0	158	125	1.0
20	6.8	D/1510	T497D685(1)020(2)(3)(4)(5)	1.4	6.0	5.0	126	125	1.0
20	6.8	E/2010	T497E685(1)020(2)(3)(4)(5)	1.4	6.0	5.0	134	125	1.0
20	6.8	F/2214	T497F685(1)020(2)(3)(4)(5)	1.4	6.0	2.4	204	125	1.0
20	10	F/2214	T497F106(1)020(2)(3)(4)(5)	2.0	6.0	3.0	183	125	1.0
20	15	F/2214	T497F156(1)020(2)(3)(4)(5)	3.0	6.0	3.0	183	125	1.0
20	15	G/2711	T497G156(1)020(2)(3)(4)(5)	3.0	6.0	1.1	337	125	1.0
20	22	G/2711	T497G226(1)020(2)(3)(4)(5)	4.4	6.0	2.5	224	125	1.0
20	22	H/2915	T497H226(1)020(2)(3)(4)(5)	4.4	6.0	0.9	408	125	1.0
20	33	H/2915	T497H336(1)020(2)(3)(4)(5)	6.6	8.0	0.9	408	125	1.0
20	47	H/2915	T497H476(1)020(2)(3)(4)(5)	9.4	8.0	0.9	408	125	1.0
25	0.33	A/1005	T497A334(1)025(2)(3)(4)(5)	0.1	6.0	15.0	58	125	1.0
25	0.47	A/1005	T497A474(1)025(2)(3)(4)(5)	0.1	6.0	15.0	58	125	1.0
VDC at 85°C	µF	KEMET/EIA	(See below for part options)	µA at +25°C Maximum/5 Min.	% at 25°C 120 Hz Maximum	Ω at +25°C 100 kHz Maximum	100kHz, 25 °C	°C	Reflow Temp. ≤ 260°C
Rated Voltage	Rated Cap	Case Code/ Case Size	KEMET Part Number	DC Leakage	DF	ESR	Ripple Current (mArms)	Maximum Operating Temp	MSL

- (1) To complete KEMET part number, insert M for ±20% or K for ±10%. Designates Capacitance tolerance.
 (2) To complete KEMET part number, insert B (0.1%/1,000 hours), C (0.01%/1,000 hours) or A = N/A. Designates Reliability Level.
 (3) To complete KEMET part number, insert T = 100% Matte Tin (Sn)-plated, B = Gold-plated, H = Standard Solder coated (SnPb 5% Pb minimum), C = Hot Solder Dipped, K = Solder Fused. Designates Termination Finish.
 (4) To complete KEMET part number, insert 61 = Standard (in-process), 62 = 10 Cycles after Weibull, +25°C, 63 = 10 Cycles after Weibull, -55° and +85°C or 64 = 10 cycles before Weibull, -55°C and +85°C.
 (5) To complete KEMET part number, insert 10 = None or 15 = 100%. Designates X-ray inspection.
 (6) To complete KEMET part number, insert 10 = Standard, 11 = F-Tech & SBDS, 12 = SBDS, 13 = F-Tech, 15 = 100% X-ray, 16 = F-Tech & SBDS, & 100% X-ray, 17 = SBDS & 100%, X-ray, 18 = F-Tech & 100%X-ray. Designates screening.
 Designates Termination Finish.
 Refer to Ordering Information for additional detail.
 Higher voltage ratings and tighter tolerance product including ESR may be substituted within the same size at KEMET's option. Voltage substitution will be marked with the higher voltage rating. Substitutions can include better than series.

Table 1 – Ratings & Part Number Reference cont.

Rated Voltage	Rated Cap	Case Code/ Case Size	KEMET Part Number	DC Leakage	DF	ESR	Ripple Current (mArms)	Maximum Operating Temp	MSL
VDC at 85°C	µF	KEMET/EIA	(See below for part options)	µA at +25°C Maximum/5 Min.	% at 25°C 120 Hz Maximum	Ω at +25°C 100 kHz Maximum	100kHz, 25 °C	°C	Reflow Temp. ≤ 260°C
25	0.68	B/1505	T497B684(1)025(2)(3)(4)(5)	0.2	6.0	7.5	82	125	1.0
25	1	B/1505	T497B105(1)025(2)(3)(4)(5)	0.3	6.0	10.0	71	125	1.0
25	1	C/2005	T497C105(1)025(2)(3)(4)(5)	0.3	6.0	6.5	42	125	1.0
25	1.5	D/1510	T497D155(1)025(2)(3)(4)(5)	0.4	6.0	6.5	119	125	1.0
25	2.2	D/1510	T497D225(1)025(2)(3)(4)(5)	0.6	6.0	6.0	115	125	1.0
25	2.2	E/2010	T497E225(1)025(2)(3)(4)(5)	0.6	6.0	3.5	160	125	1.0
25	3.3	E/2010	T497E335(1)025(2)(3)(4)(5)	0.8	6.0	4.0	150	125	1.0
25	4.7	F/2214	T497F475(1)025(2)(3)(4)(5)	1.2	6.0	2.5	200	125	1.0
25	6.8	F/2214	T497F685(1)025(2)(3)(4)(5)	1.7	6.0	3.0	183	125	1.0
25	6.8	G/2711	T497G685(1)025(2)(3)(4)(5)	1.7	6.0	1.2	323	125	1.0
25	10	F/2214	T497F106(1)025(2)(3)(4)(5)	2.5	6.0	2.5	200	125	1.0
25	10	G/2711	T497G106(1)025(2)(3)(4)(5)	2.5	6.0	1.4	299	125	1.0
25	15	G/2711	T497G156(1)025(2)(3)(4)(5)	3.8	6.0	1.4	299	125	1.0
25	15	H/2915	T497H156(1)025(2)(3)(4)(6)	3.8	6.0	1.0	387	125	1.0
25	22	G/2711	T497G226(1)025(2)(3)(4)(5)	5.5	6.0	1.4	299	125	1.0
25	22	H/2915	T497H226(1)025(2)(3)(4)(6)	5.5	6.0	0.9	408	125	1.0
25	22	X/2824	T497X226(1)025(2)(3)(4)(5)	5.5	6.0	0.9	428	125	1.0
25	33	H/2915	T497H336(1)025(2)(3)(4)(6)	8.3	8.0	0.9	408	125	1.0
25	33	X/2824	T497X336(1)025(2)(3)(4)(5)	8.3	8.0	0.9	428	125	1.0
35	0.22	A/1005	T497A224(1)035(2)(3)(4)(5)	0.1	6.0	18.0	53	125	1.0
35	0.33	A/1005	T497A334(1)035(2)(3)(4)(5)	0.1	6.0	22.0	48	125	1.0
35	0.47	B/1505	T497B474(1)035(2)(3)(4)(5)	0.2	6.0	10.0	71	125	1.0
35	0.68	C/2005	T497C684(1)035(2)(3)(4)(5)	0.2	6.0	8.0	97	125	1.0
35	1	D/1510	T497D105(1)035(2)(3)(4)(5)	0.4	6.0	6.5	119	125	1.0
35	1.5	E/2010	T497E155(1)035(2)(3)(4)(5)	0.5	6.0	4.5	141	125	1.0
35	3.3	F/2214	T497F335(1)035(2)(3)(4)(5)	1.2	6.0	2.5	200	125	1.0
35	4.7	G/2711	T497G475(1)035(2)(3)(4)(5)	1.6	6.0	1.5	289	125	1.0
35	6.8	G/2711	T497G685(1)035(2)(3)(4)(5)	2.4	6.0	1.3	310	125	1.0
35	6.8	H/2915	T497H685(1)035(2)(3)(4)(6)	2.4	6.0	1.3	340	125	1.0
35	10	H/2915	T497H106(1)035(2)(3)(4)(6)	3.5	8.0	0.9	408	125	1.0
35	15	X/2824	T497X156(1)035(2)(3)(4)(5)	5.3	6.0	0.9	428	125	1.0
50	0.1	A/1005	T497A104(1)050(2)(3)(4)(5)	0.1	6.0	22.0	48	125	1.0
50	0.15	A/1005	T497A154(1)050(2)(3)(4)(5)	0.1	6.0	17.0	54	125	1.0
50	0.22	B/1505	T497B224(1)050(2)(3)(4)(5)	0.1	6.0	14.0	60	125	1.0
50	0.33	B/1505	T497B334(1)050(2)(3)(4)(5)	0.2	6.0	12.0	65	125	1.0
50	0.47	C/2005	T497C474(1)050(2)(3)(4)(5)	0.2	6.0	8.0	97	125	1.0
50	0.68	D/1510	T497D684(1)050(2)(3)(4)(5)	0.3	6.0	7.0	107	125	1.0
50	1	E/2010	T497E105(1)050(2)(3)(4)(5)	0.5	6.0	6.0	122	125	1.0
50	1.5	F/2214	T497F155(1)050(2)(3)(4)(5)	0.8	6.0	4.0	158	125	1.0
50	2.2	F/2214	T497F225(1)050(2)(3)(4)(5)	1.1	6.0	2.5	200	125	1.0
50	3.3	G/2711	T497G335(1)050(2)(3)(4)(5)	1.7	6.0	2.0	250	125	1.0
50	4.7	H/2915	T497H475(1)050(2)(3)(4)(6)	2.4	6.0	1.5	316	125	1.0
VDC at 85°C	µF	KEMET/EIA	(See below for part options)	µA at +25°C Maximum/5 Min.	% at 25°C 120 Hz Maximum	Ω at +25°C 100 kHz Maximum	100kHz, 25 °C	°C	Reflow Temp. ≤ 260°C
Rated Voltage	Rated Cap	Case Code/ Case Size	KEMET Part Number	DC Leakage	DF	ESR	Ripple Current (mArms)	Maximum Operating Temp	MSL

(1) To complete KEMET part number, insert M for ±20% or K for ±10%. Designates Capacitance tolerance.
(2) To complete KEMET part number, insert B (0.1%/1,000 hours), C (0.01%/1,000 hours) or A = N/A. Designates Reliability Level.
(3) To complete KEMET part number, insert T = 100% Matte Tin (Sn)-plated, B = Gold-plated, H = Standard Solder coated (SnPb 5% Pb minimum), C = Hot Solder Dipped, K = Solder Fused. Designates Termination Finish.
(4) To complete KEMET part number, insert 61 = Standard (in-process), 62 = 10 Cycles after Weibull, +25°C, 63 = 10 Cycles after Weibull, -55° and +85°C or 64 = 10 cycles before Weibull, -55°C and +85°C.
(5) To complete KEMET part number, insert 10 = None or 15 = 100%. Designates X-ray inspection.
(6) To complete KEMET part number, insert 10 = Standard, 11 = F-Tech & SBDS, 12 = SBDS, 13 = F-Tech, 15 = 100% X-ray, 16 = F-Tech & SBDS, & 100% X-ray, 17 = SBDS & 100%, X-ray, 18 = F-Tech & 100%X-ray. Designates screening. Designates Termination Finish. Refer to Ordering Information for additional detail.
Higher voltage ratings and tighter tolerance product including ESR may be substituted within the same size at KEMET's option. Voltage substitution will be marked with the higher voltage rating. Substitutions can include better than series.

Recommended Voltage Derating Guidelines

	-55°C to 85°C	85°C to 125°C
% Change in Working DC Voltage with Temperature	V _R	67% of V _R
Recommended Maximum Application Voltage	50% of V _R	33% of V _R

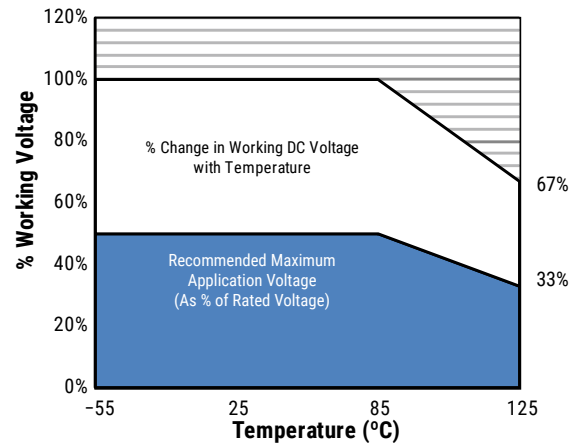

Ripple Current/Ripple Voltage

Permissible AC ripple voltage and current are related to equivalent series resistance (ESR) and the power dissipation capabilities of the device. Permissible AC ripple voltage which may be applied is limited by two criteria:

1. The positive peak AC voltage plus the DC bias voltage, if any, must not exceed the DC voltage rating of the capacitor.
2. The negative peak AC voltage in combination with bias voltage, if any, must not exceed the allowable limits specified for reverse voltage. See the Reverse Voltage section for allowable limits.

The maximum power dissipation by case size can be determined using the table at right. The maximum power dissipation rating stated in the table must be reduced with increasing environmental operating temperatures. Refer to the table below for temperature compensation requirements.

Case Code	EIA Case Code	Maximum Power Dissipation (Pmax) mWatts at 25°C with +20°C Rise
A	2513	50
B	3813	70
C	5113	75
D	3825	80
E	5125	90
F	5634	100
G	6728	125
H	7238	150
X	6954	165

Using the Pmax of the device, the maximum allowable rms ripple current or voltage may be determined.

$$I(max) = \sqrt{Pmax/R}$$

$$E(max) = Z \sqrt{Pmax/R}$$

I = rms ripple current (amperes)

E = rms ripple voltage (volts)

Pmax = maximum power dissipation (watts)

R = ESR at specified frequency (ohms)

Z = Impedance at specified frequency (ohms)

Temperature Compensation Multipliers for Maximum Ripple Current		
T ≤ 25°C	T ≤ 85°C	T ≤ 125°C
1.00	0.90	0.40

T = Environmental Temperature

The maximum power dissipation rating must be reduced with increasing environmental operating temperatures. Refer to the Temperature Compensation Multiplier table for details.

Reverse Voltage

Solid tantalum capacitors are polar devices and may be permanently damaged or destroyed if connected with the wrong polarity. The positive terminal is identified on the capacitor body by a stripe plus in some cases a beveled edge. A small degree of transient reverse voltage is permissible for short periods per the table. The capacitors should not be operated continuously in reverse mode, even within these limits.

Temperature	Permissible Transient Reverse Voltage
25°C	15% of Rated Voltage
85°C	5% of Rated Voltage
125°C	1% of Rated Voltage

Table 2 – Land Dimensions/Courtyard

KEMET	Metric Size Code	Density Level A: Maximum (Most) Land Protrusion (mm)					Density Level B: Median (Nominal) Land Protrusion (mm)					Density Level C: Minimum (Least) Land Protrusion (mm)				
		Case	EIA	L	W	S	V1	V2	L	W	S	V1	V2	L	W	S
A ¹	1005	2.19	1.44	0.15	5.54	2.66	1.89	1.32	0.15	4.44	2.16	1.52	1.22	0.29	3.58	1.90
B	1505	2.30	1.44	1.20	6.80	2.66	1.90	1.32	1.40	5.70	2.16	1.52	1.22	1.56	4.84	1.90
C	2005	2.30	1.44	2.47	8.08	2.66	1.90	1.32	2.67	6.98	2.16	1.52	1.22	2.83	6.12	1.90
D	1510	2.30	2.58	1.20	6.80	3.92	1.90	2.46	1.40	5.70	3.42	1.52	2.36	1.56	4.84	3.16
E	2010	2.30	2.58	2.47	8.08	3.92	1.90	2.46	2.67	6.98	3.42	1.52	2.36	2.83	6.12	3.16
F	2214	2.30	3.47	2.98	8.58	4.82	1.90	3.35	3.18	7.48	4.32	1.52	3.25	3.34	6.62	4.06
G	2711	2.81	2.84	3.10	9.72	4.18	2.41	2.72	3.30	8.62	3.68	2.03	2.62	3.46	7.76	3.42
H	2915	2.81	3.84	3.61	10.24	5.20	2.41	3.72	3.81	9.14	4.70	2.03	3.62	3.97	8.28	4.44
X	2824	2.73	3.22	3.46	9.92	6.80	2.33	3.10	3.66	8.82	6.30	1.95	3.00	3.82	7.96	6.04

Density Level A: For low-density product applications. Recommended for wave solder applications and provides a wider process window for reflow solder processes.

Density Level B: For products with a moderate level of component density. Provides a robust solder attachment condition for reflow solder processes.

Density Level C: For high component density product applications. Before adapting the minimum land pattern variations the user should perform qualification testing based on the conditions outlined in IPC standard 7351 (IPC-7351).

¹ Land pattern geometry is too small for silkscreen outline.

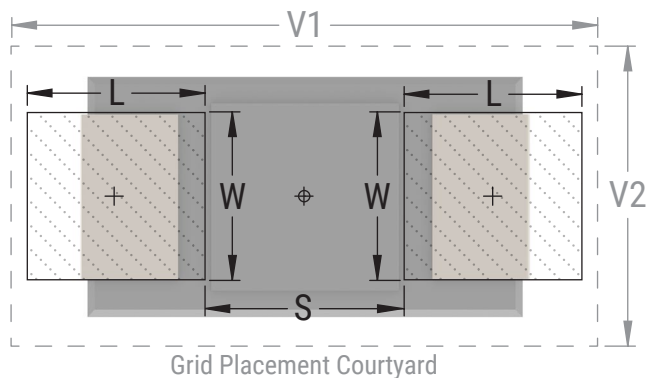

Soldering Process

The KEMET families of surface mount capacitors are compatible with wave (single or dual), convection, IR, or vapor phase reflow techniques. Preheating of these components is recommended to avoid extreme thermal stress. KEMET's recommended profile conditions for convection and IR reflow reflect the profile conditions of the IPC/J-STD-020D standard for moisture sensitivity testing. The devices can safely withstand a maximum of three reflow passes at these conditions.

Please note that although the X/7343-43 case size can withstand wave soldering, the tall profile (4.3 mm maximum) dictates care in wave process development.

Hand soldering should be performed with care due to the difficulty in process control. If performed, care should be taken to avoid contact of the soldering iron to the molded case. The iron should be used to heat the solder pad, applying solder between the pad and the termination, until reflow occurs. Once reflow occurs, the iron should be removed immediately. "Wiping" the edges of a chip and heating the top surface is not recommended.

During typical reflow operations, a slight darkening of the gold-colored epoxy may be observed. This slight darkening is normal and not harmful to the product. Marking permanency is not affected by this change.

Profile Feature	SnPb Assembly	Pb-Free Assembly
Preheat/Soak		
Temperature Minimum (T_{smin})	100°C	150°C
Temperature Maximum (T_{smax})	150°C	200°C
Time (t_s) from T_{smin} to T_{smax}	60 – 120 seconds	60 – 120 seconds
Ramp-up Rate (T_L to T_P)	3°C/second maximum	3°C/second maximum
Liquidous Temperature (T_L)	183°C	217°C
Time Above Liquidous (t_L)	60 – 150 seconds	60 – 150 seconds
Peak Temperature (T_P)	220°C* 235°C**	250°C* 260°C**
Time within 5°C of Maximum Peak Temperature (t_p)	20 seconds maximum	30 seconds maximum
Ramp-down Rate (T_P to T_L)	6°C/second maximum	6°C/second maximum
Time 25°C to Peak Temperature	6 minutes maximum	8 minutes maximum

Note: All temperatures refer to the center of the package, measured on the package body surface that is facing up during assembly reflow.

* For Case Size height > 2.5 mm

** For Case Size height ≤ 2.5 mm

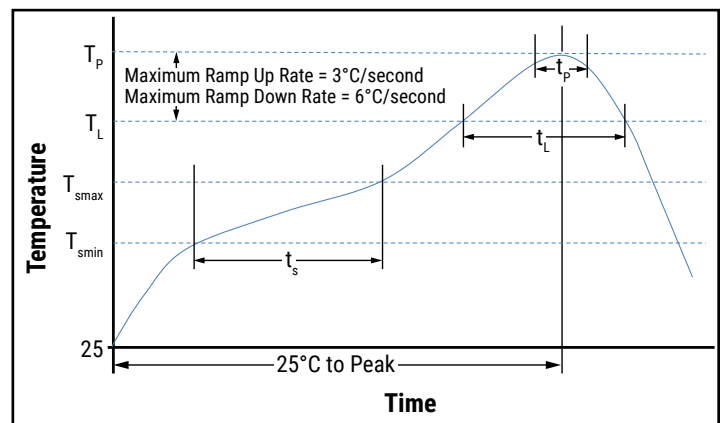

Storage

Tantalum chip capacitors should be stored in normal working environments. While the chips themselves are quite robust in other environments, solderability will be degraded by exposure to high temperatures, high humidity, corrosive atmospheres, and long term storage. In addition, packaging materials will be degraded by high temperature – reels may soften or warp and tape peel force may increase. KEMET recommends that maximum storage temperature not exceed 40°C and maximum storage humidity not exceed 60% relative humidity. Temperature fluctuations should be minimized to avoid condensation on the parts and atmospheres should be free of chlorine and sulphur bearing compounds. For optimized solderability, chip stock should be used promptly, preferably within three years of receipt.

Construction

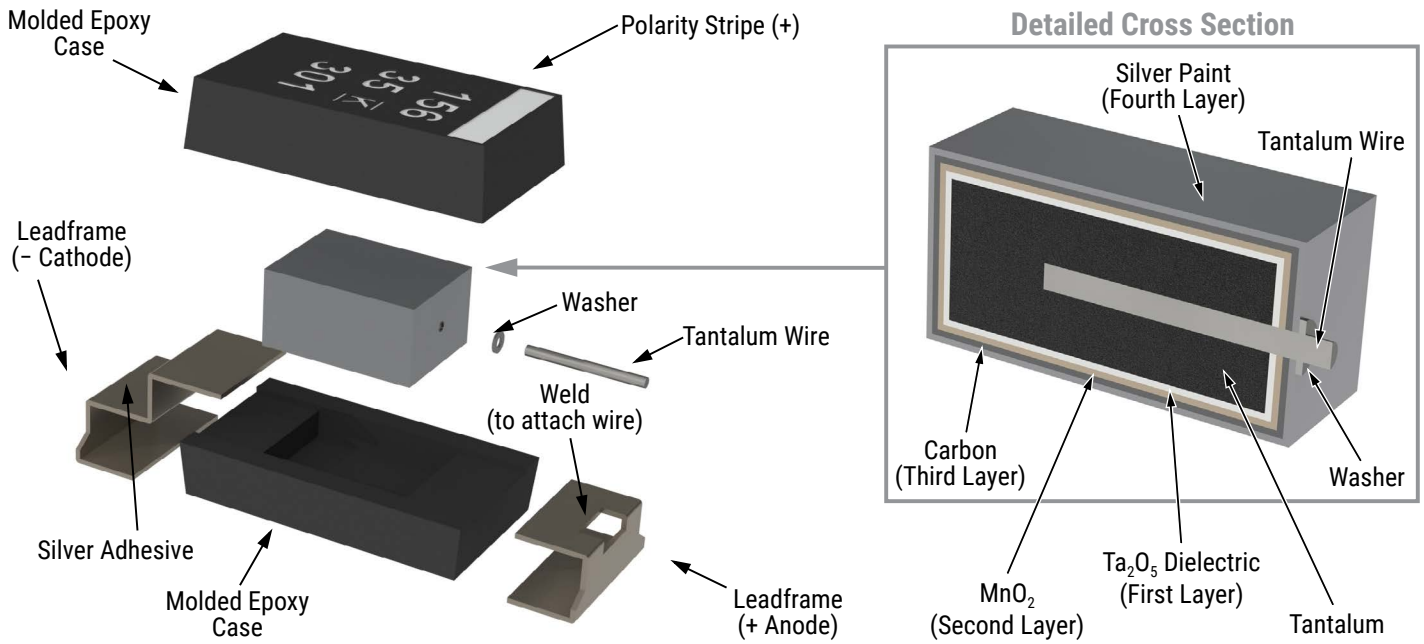

Capacitor Marking

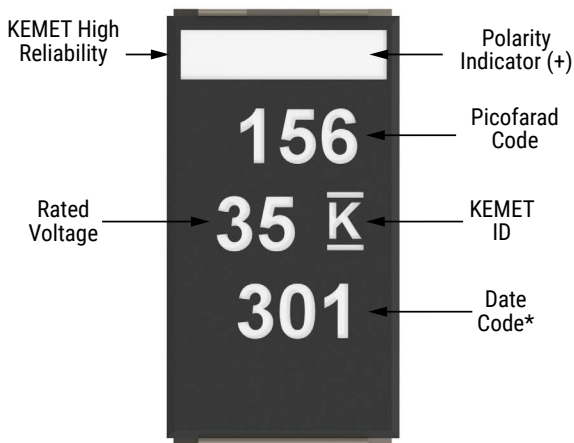

Date Code *	
1 st digit = Last number of Year	0 = 2020 1 = 2021 2 = 2022 3 = 2023 4 = 2024
2 nd and 3 rd digit = Week of the Year	01 = 1 st week of the Year to 52 = 52 nd week of the Year

Tape & Reel Packaging Information

KEMET’s molded tantalum and aluminum chip capacitor families are packaged in 8 and 12 mm plastic tape on 7” and 13” reels in accordance with *EIA Standard 481: Embossed Carrier Taping of Surface Mount Components for Automatic Handling*. This packaging system is compatible with all tape-fed automatic pick-and-place systems.

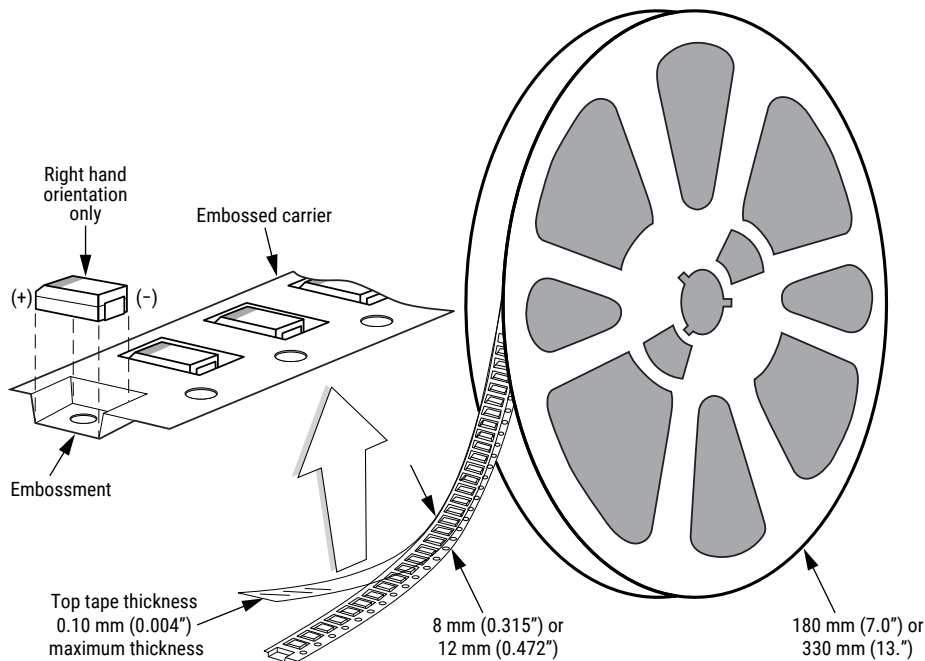

Table 3 – Packaging Quantity

KEMET Case Codes		Tape Width (mm)	Tape and Reel Dimensions	
			180 mm (7" diameter)	330 mm (13" diameter)
A	1005	8	2,500	9,500
B	1505	12	2,500	9,500
C	2005	12	2,500	9,500
D	1510	12	2,500	9,500
E	2010	12	2,500	9,500
F	2214	12	500	3,500
G	2711	12	500	2,500
H	2915	12	500	2,500
X	2824	12	500	2,500

Figure 1 – Embossed (Plastic) Carrier Tape Dimensions

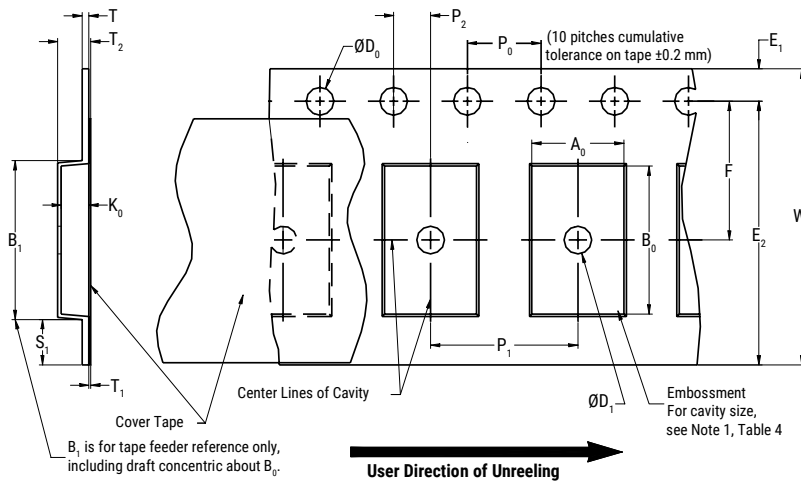

Table 4 – Embossed (Plastic) Carrier Tape Dimensions

Metric will govern

Constant Dimensions – Millimeters (Inches)									
Tape Size	D ₀	D ₁ Minimum Note 1	E ₁	P ₀	P ₂	R Reference Note 2	S ₁ Minimum Note 3	T Maximum	T ₁ Maximum
8 mm	1.5 +0.10/-0.0 (0.059 +0.004/-0.0)	1.0 (0.039)	1.75 ±0.10 (0.069 ±0.004)	4.0 ±0.10 (0.157 ±0.004)	2.0 ±0.05 (0.079 ±0.002)	25.0 (0.984)	0.600 (0.024)	0.600 (0.024)	0.100 (0.004)
12 mm		1.5 (0.059)							

Variable Dimensions – Millimeters (Inches)									
Tape Size	Pitch	B ₁ Maximum Note 4	E ₂ Minimum	F	P ₁	T ₂ Maximum	W Maximum	A ₀ , B ₀ & K ₀	
8 mm	Single (4 mm)	4.35 (0.171)	6.25 (0.246)	3.5 ±0.05 (0.138 ±0.002)	2.0 ±0.05 or 4.0 ±0.10 (0.079 ±0.002 or 0.157 ±0.004)	2.5 (0.098)	8.3 (0.327)	Note 5	
12 mm	Single (4 mm) and Double (8 mm)	8.2 (0.323)	10.25 (0.404)	5.5 ±0.05 (0.217 ±0.002)	2.0 ±0.05 (0.079 ±0.002) or 4.0 ±0.10 (0.157 ±0.004) or 8.0 ±0.10 (0.315 ±0.004)	4.6 (0.181)	12.3 (0.484)		

1. The embossment hole location shall be measured from the sprocket hole controlling the location of the embossment. Dimensions of embossment location and hole location shall be applied independent of each other.
2. The tape, with or without components, shall pass around R without damage (see Figure 4).
3. If S₁ < 1.0 mm, there may not be enough area for cover tape to be properly applied (see EIA Standard 481–D, paragraph 4.3, section b).
4. B₁ dimension is a reference dimension for tape feeder clearance only.
5. The cavity defined by A₀, B₀ and K₀ shall surround the component with sufficient clearance that:
 - (a) the component does not protrude above the top surface of the carrier tape.
 - (b) the component can be removed from the cavity in a vertical direction without mechanical restriction, after the top cover tape has been removed.
 - (c) rotation of the component is limited to 20° maximum for 8 and 12 mm tapes (see Figure 2).
 - (d) lateral movement of the component is restricted to 0.5 mm maximum for 8 mm and 12 mm wide tape (see Figure 3).
 - (e) see Addendum in EIA Standard 481–D for standards relating to more precise taping requirements.

Packaging Information Performance Notes

- Cover Tape Break Force:** 1.0 kg minimum.
- Cover Tape Peel Strength:** The total peel strength of the cover tape from the carrier tape shall be:

Tape Width	Peel Strength
8 mm	0.1 to 1.0 Newton (10 to 100 gf)
12 and 16 mm	0.1 to 1.3 Newton (10 to 130 gf)

The direction of the pull shall be opposite the direction of the carrier tape travel. The pull angle of the carrier tape shall be 165° to 180° from the plane of the carrier tape. During peeling, the carrier and/or cover tape shall be pulled at a velocity of 300 ±10 mm/minute.

- Labeling:** Bar code labeling (standard or custom) shall be on the side of the reel opposite the sprocket holes. Refer to EIA Standards 556 and 624.

Figure 2 – Maximum Component Rotation

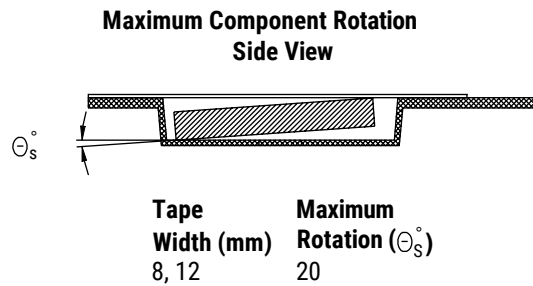

Figure 3 – Maximum Lateral Movement



Figure 4 – Bending Radius



Figure 5 – Reel Dimensions

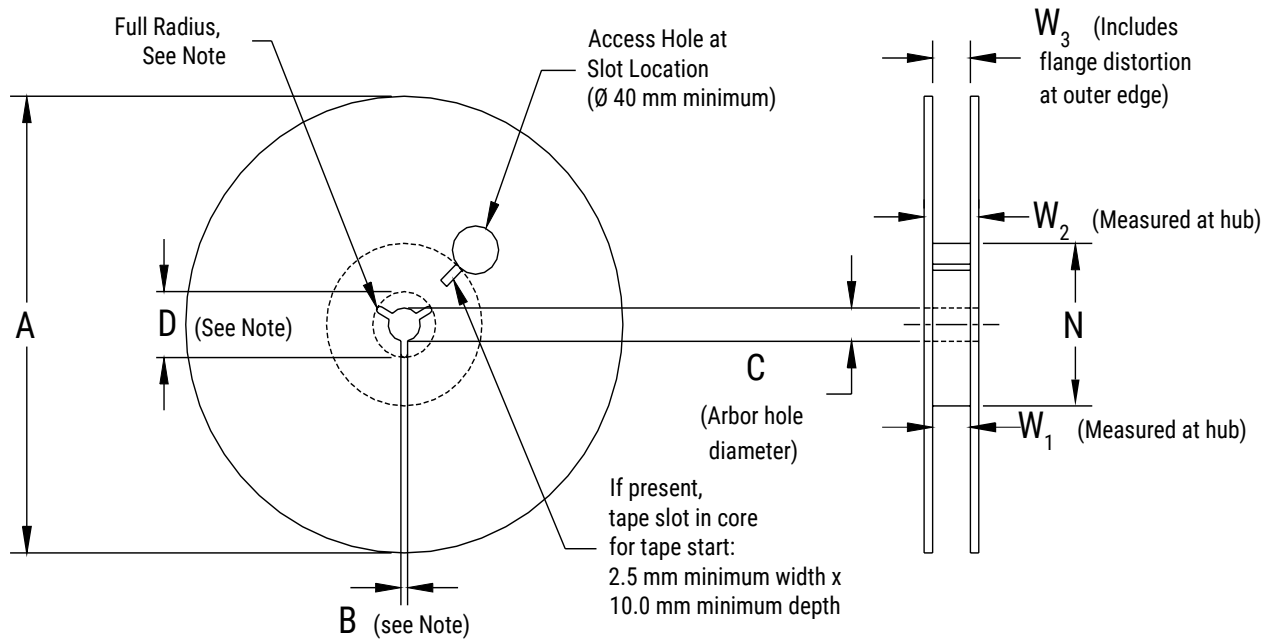

Note: Drive spokes optional; if used, dimensions B and D shall apply.

Table 5 – Reel Dimensions

Metric will govern

Constant Dimensions – Millimeters (Inches)				
Tape Size	A	B Minimum	C	D Minimum
8 mm	178 ±0.20 (7.008 ±0.008)	1.5 (0.059)	13.0 +0.5/-0.2 (0.521 +0.02/-0.008)	20.2 (0.795)
12 mm	330 ±0.20 (13.000 ±0.008)			
Variable Dimensions – Millimeters (Inches)				
Tape Size	N Minimum	W ₁	W ₂ Maximum	W ₃
8 mm	50 (1.969)	8.4 +1.5/-0.0 (0.331 +0.059/-0.0)	14.4 (0.567)	Shall accommodate tape width without interference
12 mm		12.4 +2.0/-0.0 (0.488 +0.078/-0.0)	18.4 (0.724)	

Figure 6 – Tape Leader & Trailer Dimensions



Figure 7 – Maximum Camber

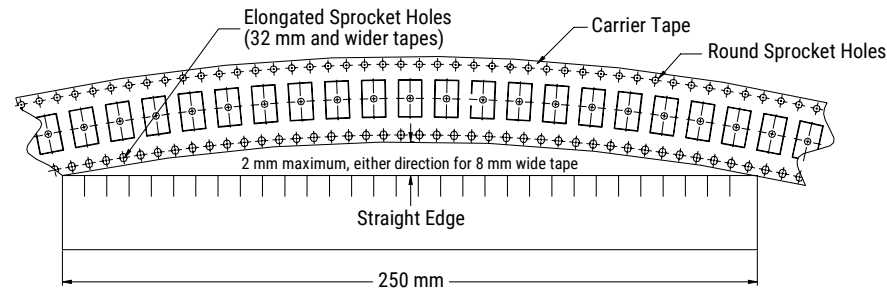

KEMET Electronics Corporation Sales Offices

For a complete list of our global sales offices, please visit www.kemet.com/sales.

Disclaimer

All product specifications, statements, information and data (collectively, the "Information") in this datasheet are subject to change. The customer is responsible for checking and verifying the extent to which the Information contained in this publication is applicable to an order at the time the order is placed. All Information given herein is believed to be accurate and reliable, but it is presented without guarantee, warranty, or responsibility of any kind, expressed or implied.

Statements of suitability for certain applications are based on KEMET Electronics Corporation's ("KEMET") knowledge of typical operating conditions for such applications, but are not intended to constitute – and KEMET specifically disclaims – any warranty concerning suitability for a specific customer application or use. The Information is intended for use only by customers who have the requisite experience and capability to determine the correct products for their application. Any technical advice inferred from this Information or otherwise provided by KEMET with reference to the use of KEMET's products is given gratis, and KEMET assumes no obligation or liability for the advice given or results obtained.

Although KEMET designs and manufactures its products to the most stringent quality and safety standards, given the current state of the art, isolated component failures may still occur. Accordingly, customer applications which require a high degree of reliability or safety should employ suitable designs or other safeguards (such as installation of protective circuitry or redundancies) in order to ensure that the failure of an electrical component does not result in a risk of personal injury or property damage.

Although all product-related warnings, cautions and notes must be observed, the customer should not assume that all safety measures are indicated or that other measures may not be required.

KEMET is a registered trademark of KEMET Electronics Corporation.