



# WLD26P-1H1121A0ZZZ

W26

COMPACT PHOTOELECTRIC SENSORS

**SICK**  
Sensor Intelligence.



Illustration may differ



### Ordering information

Type	Part no.
WLD26P-1H1121A0ZZZ	1218805

Other models and accessories → [www.sick.com/W26](http://www.sick.com/W26)

### Detailed technical data

#### Features

<b>Sensor/ detection principle</b>	Photoelectric retro-reflective sensor, Dual lens
<b>Dimensions (W x H x D)</b>	24.6 mm x 82.5 mm x 53.3 mm
<b>Housing design (light emission)</b>	Rectangular
<b>Sensing range max.</b>	0.25 m ... 19 m <sup>1)</sup>
<b>Type of light</b>	Visible red light
<b>Light source</b>	PinPoint LED <sup>2)</sup>
<b>Light spot size (distance)</b>	Ø 16 mm (1 m)
<b>Wave length</b>	635 nm
<b>Indication</b>	
LED indicator green	Operating indicator Static: power on
LED indicator yellow	Status of received light beam Static: object not present Static off: object present Flashing: Below the 1.5 function reserve

<sup>1)</sup> Reflector PL80A.

<sup>2)</sup> Average service life: 100,000 h at T<sub>U</sub> = +25 °C.

## Mechanics/electronics

<b>Supply voltage</b>	10 V DC ... 30 V DC <sup>1)</sup>
<b>Ripple</b>	< 5 V <sub>pp</sub>
<b>Current consumption</b>	30 mA
<b>Switching output</b>	Push-pull: PNP/NPN
<b>Output function</b>	Complementary, factory setting: Pin 2 / white: NPN normally closed (light switching), PNP normally open (dark switching), Pin 4 / black: NPN normally open (dark switching), PNP normally closed (light switching)
<b>Switching mode</b>	Light/dark switching
<b>Signal voltage PNP HIGH/LOW</b>	Approx. V <sub>S</sub> - 2.5 V / 0 V
<b>Signal voltage NPN HIGH/LOW</b>	Approx. V <sub>S</sub> / < 2.5 V
<b>Output current I<sub>max.</sub></b>	≤ 100 mA
<b>Response time</b>	≤ 500 μs <sup>2)</sup>
<b>Switching frequency</b>	1,000 Hz <sup>3)</sup>
<b>Connection type</b>	Cable, 4-wire, 2 m <sup>4)</sup>
<b>Cable material</b>	PVC
<b>Circuit protection</b>	A <sup>5)</sup> B <sup>6)</sup> C <sup>7)</sup> D <sup>8)</sup>
<b>Protection class</b>	III
<b>Weight</b>	130 g
<b>Polarisation filter</b>	✓
<b>Housing material</b>	Plastic, VISTAL®
<b>Optics material</b>	Plastic, PMMA
<b>Enclosure rating</b>	IP66 (According to EN 60529) IP67 (According to EN 60529) IP69 (According to EN 60529) <sup>9)</sup>
<b>Ambient operating temperature</b>	-40 °C ... +60 °C
<b>Ambient temperature, storage</b>	-40 °C ... +75 °C
<b>UL File No.</b>	NRKH.E181493 & NRKH7.E181493

<sup>1)</sup> Limit values.

<sup>2)</sup> Signal transit time with resistive load in switching mode.

<sup>3)</sup> With light/dark ratio 1:1 in switching mode.

<sup>4)</sup> Do not bend below 0 °C.

<sup>5)</sup> A = V<sub>S</sub> connections reverse-polarity protected.

<sup>6)</sup> B = inputs and output reverse-polarity protected.

<sup>7)</sup> C = interference suppression.

<sup>8)</sup> D = outputs overcurrent and short-circuit protected.

<sup>9)</sup> Replaces IP69K with ISO 20653: 2013-03.

## Safety-related parameters

<b>MTTF<sub>D</sub></b>	2,039 years
<b>DC<sub>avg</sub></b>	0 %

## Classifications

<b>ECI@ss 5.0</b>	27270902
-------------------	----------

<b>ECl@ss 5.1.4</b>	27270902
<b>ECl@ss 6.0</b>	27270902
<b>ECl@ss 6.2</b>	27270902
<b>ECl@ss 7.0</b>	27270902
<b>ECl@ss 8.0</b>	27270902
<b>ECl@ss 8.1</b>	27270902
<b>ECl@ss 9.0</b>	27270902
<b>ECl@ss 10.0</b>	27270902
<b>ECl@ss 11.0</b>	27270902
<b>ETIM 5.0</b>	EC002717
<b>ETIM 6.0</b>	EC002717
<b>ETIM 7.0</b>	EC002717
<b>ETIM 8.0</b>	EC002717
<b>UNSPSC 16.0901</b>	39121528

### Connection diagram

Cd-094

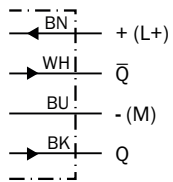

### Characteristic curve

Operating reserve

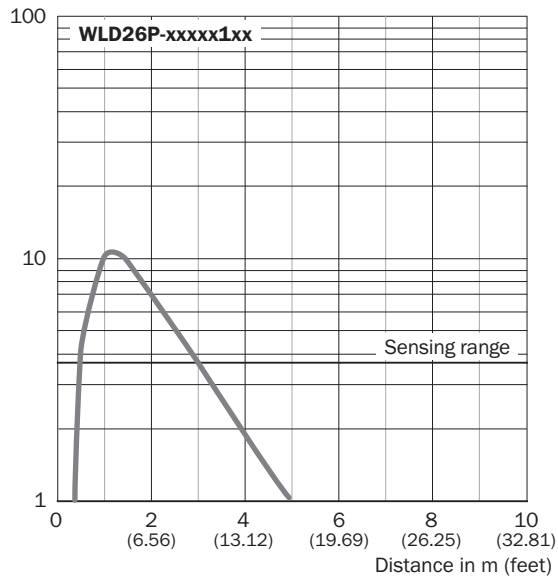

① Reflective tape REF-IRF-56 (50 x 70 mm)

Operating reserve

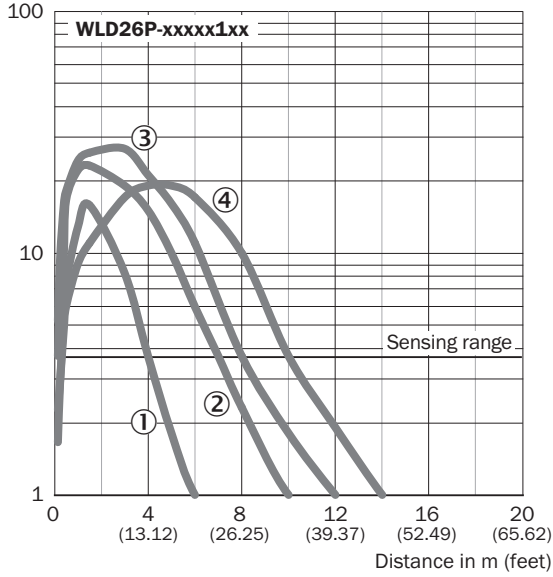

- ① Reflector PL20 CHEM
- ② Reflector P250 CHEM
- ③ Reflector P250H
- ④ Reflector PL40A Antifog

Operating reserve

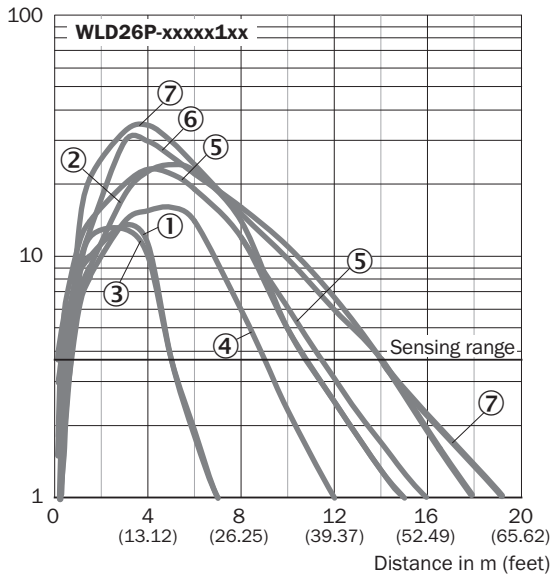

- ① Reflector PL22
- ② Reflector P250
- ③ Reflector PL20A
- ④ Reflector PL30A
- ⑤ Reflector PL40A
- ⑥ Reflector C110
- ⑦ Reflector PL80A

### Light spot size

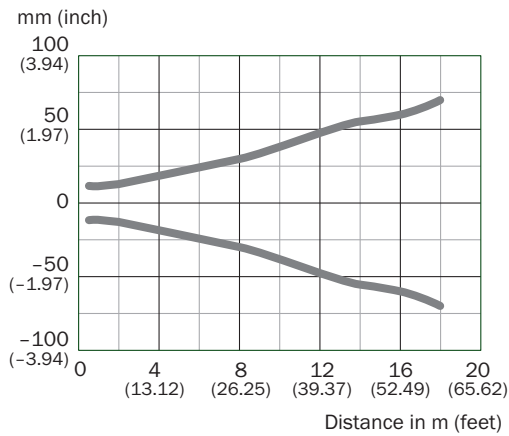

### Sensing range diagram

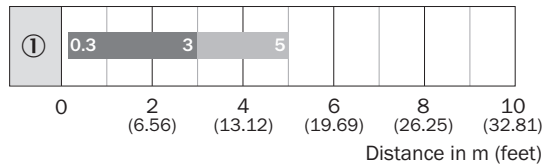

■ Sensing range      ■ Sensing range max.

① Reflective tape REF-IRF-56 (50 x 70 mm)

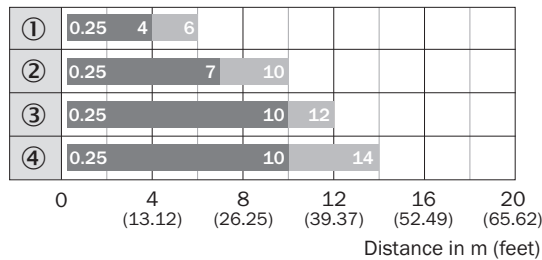

■ Sensing range      ■ Sensing range max.

- ① Reflector PL20 CHEM
- ② Reflector P250 CHEM
- ③ Reflector P250H
- ④ Reflector PL40A Antifog

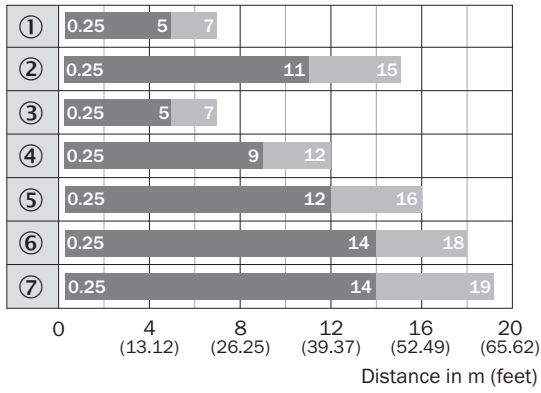

- Sensing range
- Sensing range max.
- ① Reflector PL22
- ② Reflector P250
- ③ Reflector PL20A
- ④ Reflector PL30A
- ⑤ Reflector PL40A
- ⑥ Reflector C110
- ⑦ Reflector PL80A

## Functions

### Operation note

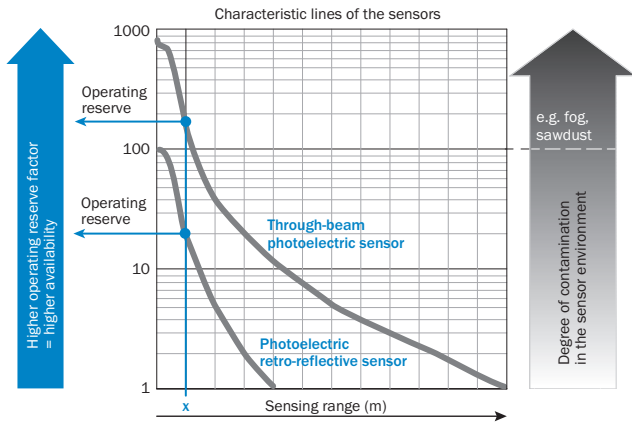

At a sensing range of „x“ the photoelectric retro-reflective and through-beam photoelectric sensors have different operating reserves (see blue arrow). The higher the operating reserve factor, the better the sensor can compensate the contamination in the air or in the light beam and on the optical surfaces (front screen, reflector), i.e. the sensor has the maximum availability, otherwise the sensor switches due to pollution although there is no object in the path of the light beam.

### Adjustments

Display and adjustment elements

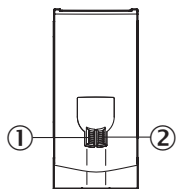

- ① LED indicator green
- ② LED indicator yellow

### Dimensional drawing (Dimensions in mm (inch))

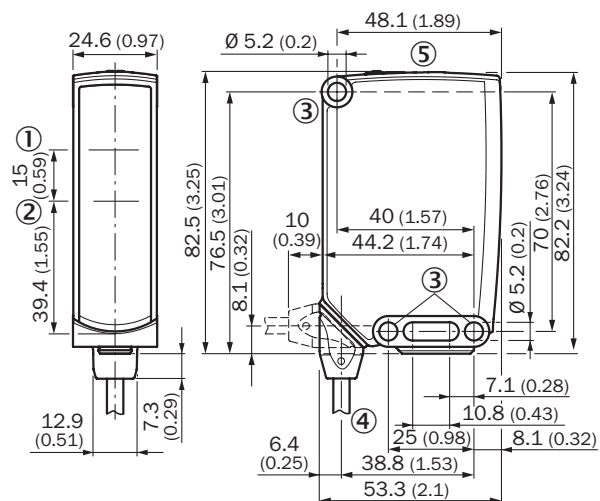

WLD26, cable



- ① Center of optical axis, sender
- ② Center of optical axis, receiver
- ③ Mounting hole,  $\varnothing$  5.2 mm
- ④ Connection
- ⑤ Display and adjustment elements

### Recommended accessories

Other models and accessories → [www.sick.com/W26](http://www.sick.com/W26)

	Brief description	Type	Part no.
Universal bar clamp systems			
	Plate N12 for universal clamp. For mounting PL30A, P250 reflectors, W27 and WTR2 sensors., Zinc plated steel (sheet), Zinc die cast (clamping bracket), Universal clamp (2022726), mounting hardware	BEF-KHS-N12	2071950
Mounting brackets and plates			
	Universal mounting bracket for reflectors, steel, zinc coated	BEF-WN-REFX	2064574



	<b>Brief description</b>	<b>Type</b>	<b>Part no.</b>
Reflectors			
	Rectangular, screw connection, 84 mm x 84 mm, PMMA/ABS, Screw-on, 2 hole mounting	PL80A	1003865

## SICK AT A GLANCE

SICK is one of the leading manufacturers of intelligent sensors and sensor solutions for industrial applications. A unique range of products and services creates the perfect basis for controlling processes securely and efficiently, protecting individuals from accidents and preventing damage to the environment.

We have extensive experience in a wide range of industries and understand their processes and requirements. With intelligent sensors, we can deliver exactly what our customers need. In application centers in Europe, Asia and North America, system solutions are tested and optimized in accordance with customer specifications. All this makes us a reliable supplier and development partner.

Comprehensive services complete our offering: SICK LifeTime Services provide support throughout the machine life cycle and ensure safety and productivity.

For us, that is “Sensor Intelligence.”

## WORLDWIDE PRESENCE:

Contacts and other locations –[www.sick.com](http://www.sick.com)