

**Data sheet | Item number: 2092-3103/002-1000**

1-conductor female connector; push-button; Push-in CAGE CLAMP®; 2.5 mm<sup>2</sup>; Pin spacing 7.5 mm; 3-pole; Gripping plate sliding connector release; direct marking; 2,50 mm<sup>2</sup>; light gray

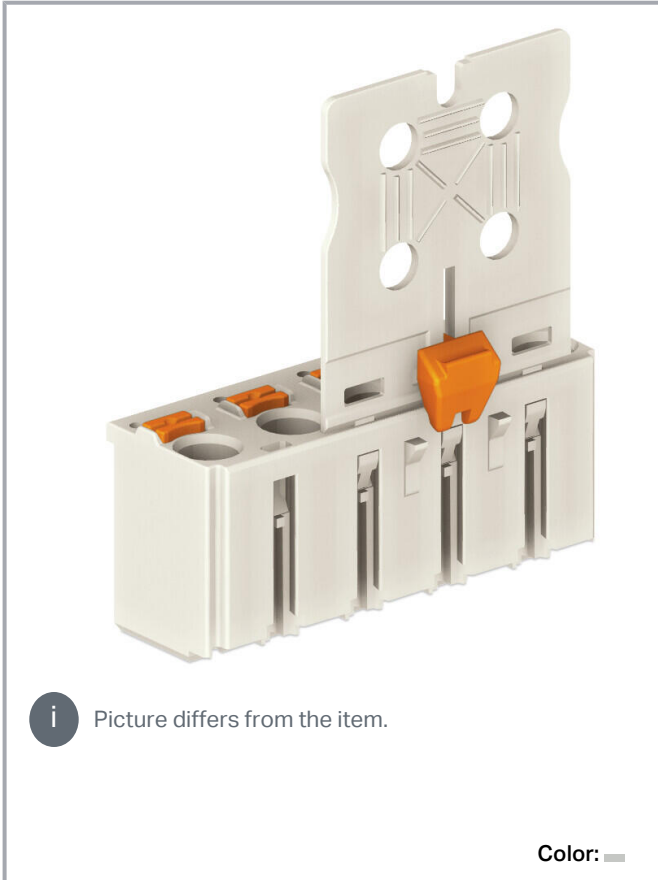

[www.wago.com/2092-3103/002-1000](http://www.wago.com/2092-3103/002-1000)



Subject to changes. Please also observe the further product documentation!

WAGO GmbH & Co. KG  
Hansastr. 27  
32423 Minden  
Phone: +49571 887-0 | Fax: +49571 887-169  
Email: [info.de@wago.com](mailto:info.de@wago.com) | Web: [www.wago.com](http://www.wago.com)

Do you have any questions about our products?  
We are always happy to take your call at +49 (571) 887-44222.

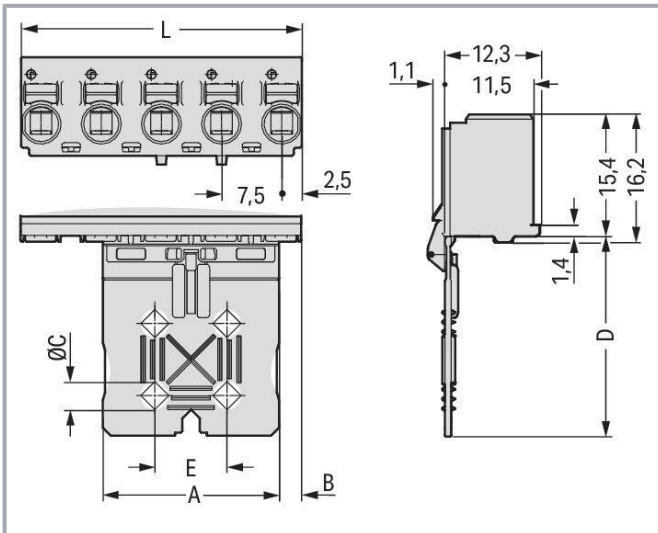

## Item description

- Universal connection of all conductor types
- Simple, push-in termination of solid and ferruled conductors
- Easy-to-use design does not require special tools
- Ability to wire while mated or unmated
- Testing parallel to conductor entry – tip contact
- Also available with gripping plates
- Integrated locking latches prevent accidental disconnection

## Data

### Notes

#### Safety information

The **picoMAX® Pluggable Connection System** includes connectors without breaking capacity in accordance with DIN EN 61984. When used as intended, these connectors must not be connected /disconnected when live or under load. The circuit design should ensure header pins, which can be touched, are not live when unmated.

#### Variants:

Direct marking

Other versions (or variants) can be requested from WAGO Sales or configured at <https://configurator.wago.com/>.

## Electrical data

Subject to changes. Please also observe the further product documentation!

WAGO GmbH & Co. KG

Hansastr. 27

32423 Minden

Phone: +49571 887-0 | Fax: +49571 887-169

Email: [info.de@wago.com](mailto:info.de@wago.com) | Web: [www.wago.com](http://www.wago.com)

Do you have any questions about our products?

We are always happy to take your call at +49 (571) 887-44222.

### Ratings per IEC/EN

Ratings per	IEC/EN 60664-1
Nominal voltage (III/3)	400 V
Rated impulse voltage (III/3)	6 kV
Rated voltage (III/2)	630 V
Rated impulse voltage (III/2)	4 kV
Nominal voltage (II/2)	1000 V
Rated surge voltage (II/2)	4 kV
Rated current	16 A
Legend (ratings)	(III / 2) $\triangleq$ Overvoltage category III / Pollution degree 2

### Ratings per UL 1059

Approvals per	UL 1059
Rated voltage UL (Use Group B)	300 V
Rated current UL (Use Group B)	15 A
Rated voltage UL (Use Group D)	300 V
Rated current UL (Use Group D)	10 A

### Connection data

Connection points	3
Total number of potentials	3
Number of connection types	1
Number of levels	1

### Connection 1

Connection technology	Push-in CAGE CLAMP <sup>®</sup>
Actuation type	Push-button
Actuation direction 1	Operation parallel to conductor entry
Solid conductor	0.2 ... 2.5 mm <sup>2</sup> / 24 ... 12 AWG
Fine-stranded conductor	0.2 ... 2.5 mm <sup>2</sup> / 24 ... 12 AWG
Fine-stranded conductor; with insulated ferrule	0.25 ... 1.5 mm <sup>2</sup>
Fine-stranded conductor; with uninsulated ferrule	0.25 ... 2.5 mm <sup>2</sup>
Strip length	9 ... 10 mm / 0.35 ... 0.39 inches
Pole number	3

Subject to changes. Please also observe the further product documentation!



## Physical data

Pin spacing	7.5 mm / 0.295 inches
Width	20 mm / 0.787 inches
Height	34 mm / 1.339 inches
Depth	13.4 mm / 0.528 inches

## Mechanical Data

Variable coding	Yes
Design	With gripping plate and sliding connector release
Anti-rotation protection	Yes

## Plug-in connection

Contact type (pluggable connector)	Female connector/socket
Connector (connection type)	for conductor
Mismating protection	No
Plugging without loss of pin spacing	Yes
Locking of plug-in connection	none

## Material Data

Note (material data)	Information on material specifications can be found here
Color	light gray
Material group	I
Insulation material	Polyphthalamide (PPA GF)
Flammability class per UL94	V0
Clamping spring material	Chrome-nickel spring steel (CrNi)
Contact material	Electrolytic copper ( $E_{Cu}$ )
Contact plating	Tin
Fire load	0.02 MJ
Weight	3.9 g

## Environmental requirements

Limit temperature range	-60 ... +100 °C
Processing temperature	-35 ... +60 °C

Subject to changes. Please also observe the further product documentation!

## Commercial data





eCl@ss 10.0	27-14-11-06
eCl@ss 9.0	27-14-11-06
ETIM 8.0	EC001284
ETIM 7.0	EC001284
PU (SPU)	100 pcs
Packaging type	box
Country of origin	DE
GTIN	4050821488415
Customs tariff number	85366990990

## Environmental Product Compliance

RoHS Compliance Status	Compliant, No Exemption
------------------------	-------------------------

## Approvals / Certificates

### General approvals

Logo	Approval	Additional Approval Text	Certificate name
	CB DEKRA Certification B.V.	IEC 61984	NL-49737 /A1
	CSA DEKRA Certification B.V.	C22.2	2362521
	cURus Underwriters Laboratories Inc.	UL 1059	E45172
	KEMA/KEUR DEKRA Certification B.V.	EN 61984	71-102261 REV.2
	UL Underwriters Laboratories Inc.	UL 1977	E45171

Subject to changes. Please also observe the further product documentation!

## Counterpart



Item no.2092-3423

THT male header; 1.4 mm Ø solder pin; angled; Pin spacing 7.5 mm; 3-pole; light gray

[www.wago.com/2092-3423](http://www.wago.com/2092-3423)



Item no.2092-3403

THT male header; 1.4 mm Ø solder pin; straight; Pin spacing 7.5 mm; 3-pole; light gray

[www.wago.com/2092-3403](http://www.wago.com/2092-3403)

## Optional accessories

### Tool

Operating tool



Item no.: 210-719

Operating tool; Blade: 2.5 x 0.4 mm; with a partially insulated shaft

[www.wago.com/210-719](http://www.wago.com/210-719)

### Testing and measuring

Testing accessories



Item no.: 735-500

WAGO Test pin; 1 mm Ø; 30 V AC / 60 V DC; CAT0; 1 A; 6 mm uninsulated; Test lead for soldering up to 0,5mm<sup>2</sup>

[www.wago.com/735-500](http://www.wago.com/735-500)

## Downloads

### Documentation

#### Additional Information

Technical Section	2019 Apr 3	pdf	Download
Technical explanations		2.0 MB	

## Environmental Product Compliance

### Compliance Search

Environmental Product Compliance 2092-3103/002-1000	URL	Download
1-conductor female connector; push-button; Push-in CAGE CLAMP®; 2.5 mm <sup>2</sup> ; Pin spacing 7.5 mm; 3-pole; Gripping plate sliding connector release; direct marking; 2,50 mm <sup>2</sup> ; light gray		

Subject to changes. Please also observe the further product documentation!

WAGO GmbH & Co. KG  
Hansastr. 27  
32423 Minden  
Phone: +49571 887-0 | Fax: +49571 887-169  
Email: [info.de@wago.com](mailto:info.de@wago.com) | Web: [www.wago.com](http://www.wago.com)

Do you have any questions about our products?  
We are always happy to take your call at +49 (571) 887-44222.

## Installation Notes

### Locking system

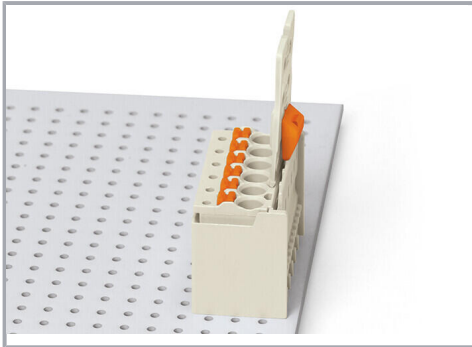

Male header mated to a female connector with gripping plate and sliding connector release.

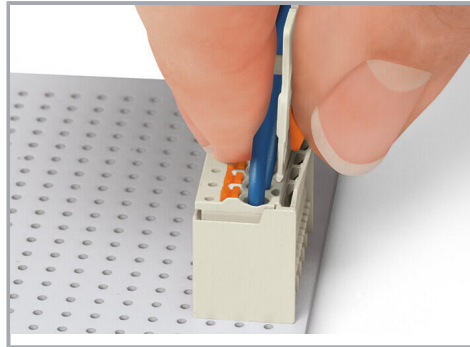

Push down sliding connector release (gripping plate) to open the locking latch.

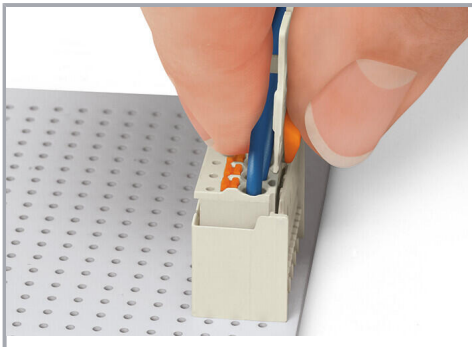

Pull out female connector from male header.

### Conductor termination

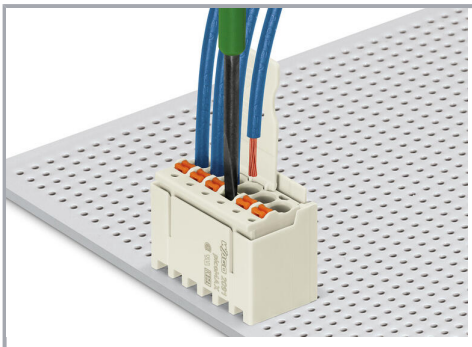

Inserting fine-stranded conductor into mated female connector via push-button.

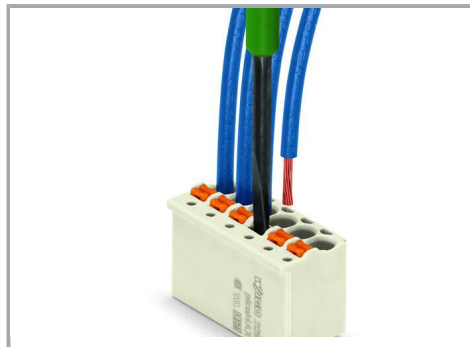

Inserting a fine-stranded conductor into an unmated female connector via push-button.

Subject to changes. Please also observe the further product documentation!

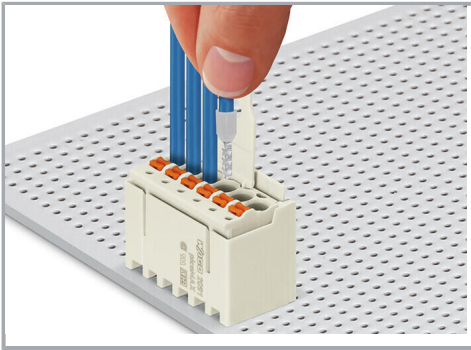

Inserting solid and ferruled conductors via push-in termination.

### Marking



Pole marking via factory direct marking.

### Coding

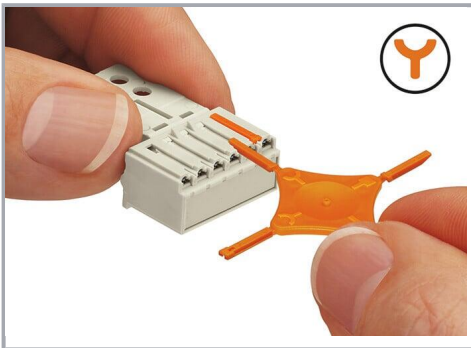

Coding a female connector (via coding key carrier and two keys for female connector, see symbol).

### Testing

Subject to changes. Please also observe the further product documentation!





Testing via 1 mm Ø test pin – touch contact.

Subject to changes. Please also observe the further product documentation!