

ALS70A133NS400

Aliases (A390TV133M400A)

ALS70, Aluminum Electrolytic, 13,000 uF, 20%, 400 VDC, -40/+85°C

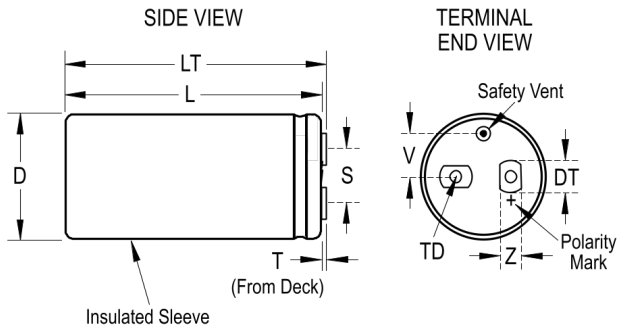

Click [here](#) for the 3D model.

Dimensions

D	77mm +/-1mm
L	194mm +/-2mm
T	5.5mm +/-0.5mm
S	31.8mm +/-0.5mm
DT	13mm +/-0.5mm
LT	198mm +/-1mm
TD	10mm MIN
V	19mm NOM
Z	10mm NOM

Packaging Specifications

Sleeving	Yes
Packaging	Tray

General Information

Series	ALS70
Dielectric	Aluminum Electrolytic
Description	Screw Terminal, Aluminum Electrolytic
RoHS	Yes
AEC-Q200	No
Halogen Free	Yes
Component Weight	1400 g
Notes	Dimensions D And L Include Sleeving. MS (MxH) = M12x16. Mounting Clamp (Sold Separately): V11
Shelf Life	156 Weeks

Specifications

Capacitance	13,000 uF
Capacitance Tolerance	20%
Voltage DC	400 VDC, 440 VDC (Surge)
Temperature Range	-40/+85°C
Rated Temperature	85°C
Life	20000 Hrs (Rated Voltage And Ripple Current At 85C), 40000 Hrs (Rated Voltage At 85C)
Resistance	18 mOhms (100Hz 20C), 12 mOhms (10kHz 20C)
Ripple Current	22.1 Amps (100Hz 85C), 29.8 Amps (10kHz 85C)
Leakage Current	6000 uA