

Motor Specifications

Part Number	BL34E21-01-RO
Dimension "A" Max	2.01 in [51mm]
Rated Voltage	24 VDC
Rated Torque	33.99 oz-in [0.24N-m]
Rated Speed	4000 RPM
Rated Power	100 Watts
Rated Current	5 Amps
Peak Torque	68 oz-in [0.48N-m]
Peak Current	10 Amps
Torque Constant (kt)	6.8 oz-in/Amp
Back EMF Constant (Ke)	4.85 Vp/KRPM
Motor Constant (Km)	16.02 oz-in/√W [0.113 N-m/√W]
Resistance	0.18 Ohms
Inductance	0.34 mH
Rotor Inertia	2.08 oz-in ²
Weight	2.16 lb [0.98 kg]
Electrical Time Constant	1.9 ms
Mechanical Time Constant	3.1 ms

Dimensions

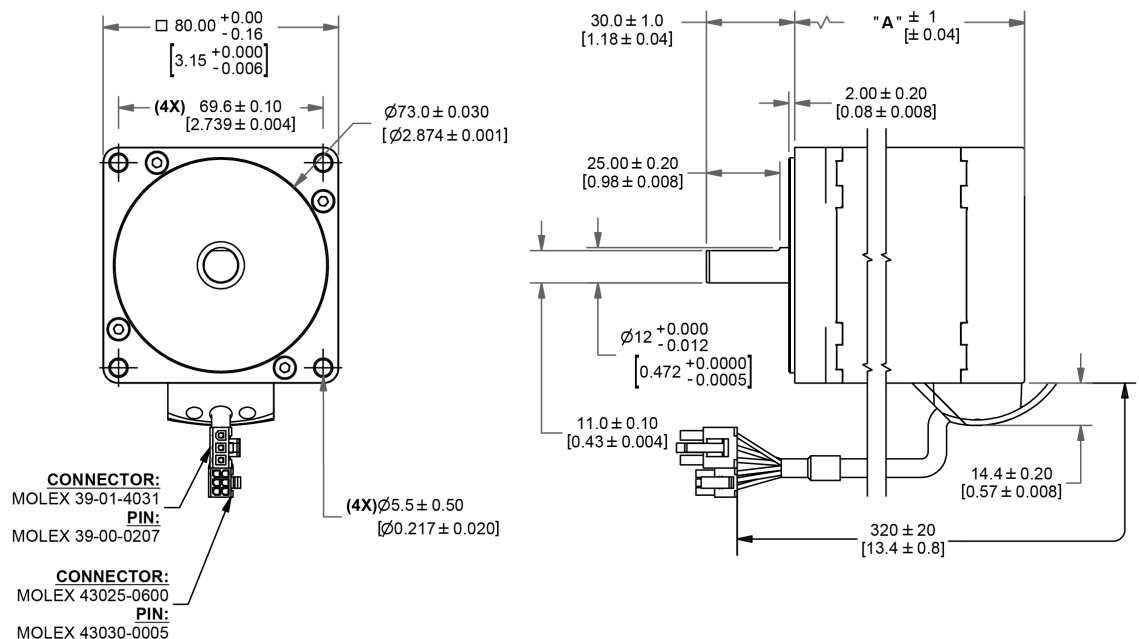

Performance Curve

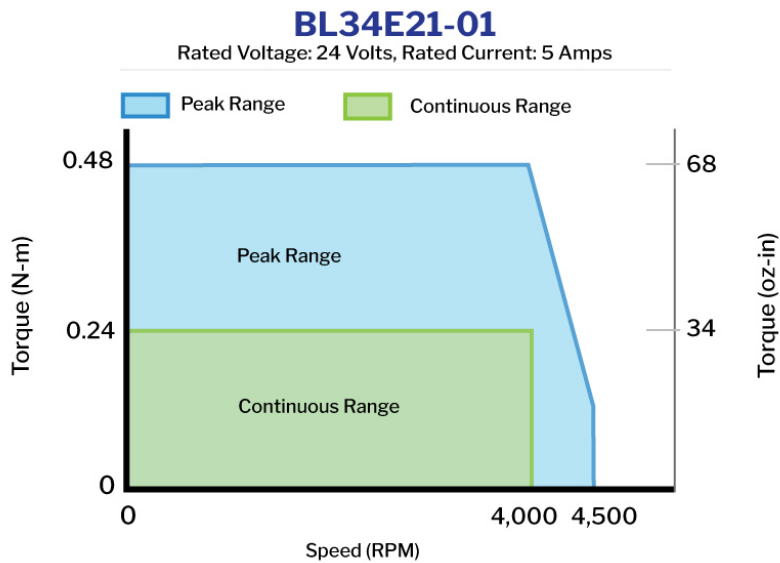

Motor Operating Specs.

Hall Effect Angle	120° electrical Angle
Radial Play	0.002 in [0.05 mm] @ 0.99 lbs [0.45 kg]
End Play	0.003 in [0.08 mm] @ 99.21 lbs [45.00 kg]
Max. Radial Force	0.787 in [20.00 mm] @ 16.80 lbs [7.62 kg]
Max. Axial Force	3.37 lbs [1.53 kg]
Insulation Class	Class B
Dielectric Strength	500 VDC for 1 minute
Insulation Resistance	100 Ω min. 500 VDC
Ambient Operating Temperature	-20°C to 50°C
Storage Temperature	-20°C to 100°C
Humidity Range (%)	85% (RH) non-condensing
Direction of Rotation	CCW

Pin Out Charts

PIN #	COLOR	PHASE
1	RED	VCC (+5V)
2	YELLOW	HV
3	BLUE	HW
4	BLACK	GND
5	ORANGE	HU

PIN #	COLOR	PHASE
1	BLUE	W
2	ORANGE	U
5	YELLOW	V

Recommended Products



BLDC DRIVER
BLDC50-BL34E21-01



BLDC EXTENSION CABLE
4201-100/300

Operation & Usage Tips

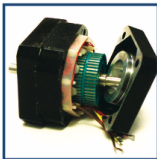

Do not disassemble motors; a significant reduction in motor performance will occur.

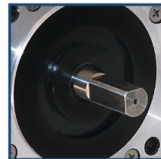

Do not machine shafts; this will have a negative effect on shaft run out and perpendicularity.

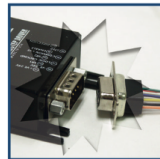

Do not disconnect motor from drive while in operation.

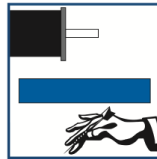

Do not use holding torque/detent torque of motor as a fail safe brake.

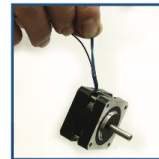

Do not hold motor by lead wires.



Do not exceed the rated current; this will burn the motor.

FAILURE TO COMPLY WITH THESE RECOMMENDATIONS WILL VOID ALL WARRANTY TERMS

Motion Control, **Solved.**

MOTOR ENGINEERING & MANUFACTURING



Optimized
For Your
Application



Quick
Prototype
Turnaround



Small Batch
to OEM Volume
Production



US Based
Support &
Manufacturing