

N-Channel Enhancement Mode Power MOSFET

Description

The GT130N10M uses advanced trench technology to provide excellent $R_{DS(ON)}$, low gate charge. It can be used in a wide variety of applications.

General Features

- V_{DS} 100V
- I_D (at $V_{GS} = 10V$) 60A
- $R_{DS(ON)}$ (at $V_{GS} = 10V$) < 12m Ω
- 100% Avalanche Tested
- RoHS Compliant

Application

- Power switch
- DC/DC converters

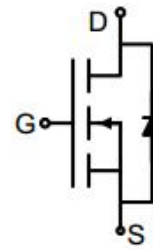

Schematic diagram

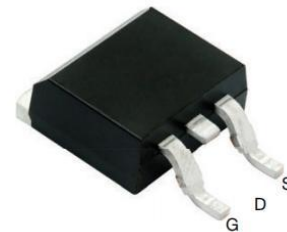

TO-263

Ordering Information

Device	Package	Marking	Packaging
GT130N10M	TO-263	GT130N10	800pcs/Reel

Absolute Maximum Ratings $T_C = 25^\circ C$, unless otherwise noted

Parameter	Symbol	Value	Unit
Drain-Source Voltage	V_{DS}	100	V
Continuous Drain Current	I_D	60	A
Pulsed Drain Current (note1)	I_{DM}	240	A
Gate-Source Voltage	V_{GS}	± 20	V
Power Dissipation	P_D	73.5	W
Single pulse avalanche energy (note2)	E_{AS}	43	mJ
Operating Junction and Storage Temperature Range	T_J, T_{stg}	-55 To 150	$^\circ C$

Thermal Resistance

Parameter	Symbol	Value	Unit
Thermal Resistance, Junction-to-Ambient	R_{thJA}	50	$^\circ C/W$
Maximum Junction-to-Case	R_{thJC}	1.7	$^\circ C/W$

Specifications $T_J = 25^\circ\text{C}$, unless otherwise noted						
Parameter	Symbol	Test Conditions	Value			Unit
			Min.	Typ.	Max.	
Static Parameters						
Drain-Source Breakdown Voltage	$V_{(BR)DSS}$	$V_{GS} = 0V, I_D = 250\mu A$	100	--	--	V
Zero Gate Voltage Drain Current	I_{DSS}	$V_{DS} = 100V, V_{GS} = 0V$	--	--	1	μA
Gate-Source Leakage	I_{GSS}	$V_{GS} = \pm 20V$	--	--	± 100	nA
Gate-Source Threshold Voltage	$V_{GS(th)}$	$V_{DS} = V_{GS}, I_D = 250\mu A$	2.0	3.0	4.0	V
Drain-Source On-Resistance	$R_{DS(on)}$	$V_{GS} = 10V, I_D = 20A$	--	9.5	12	m Ω
Forward Transconductance	g_{FS}	$V_{GS} = 5V, I_D = 20A$	--	35	--	S
Dynamic Parameters						
Input Capacitance	C_{iss}	$V_{GS} = 0V,$ $V_{DS} = 50V,$ $f = 1.0MHz$	--	1222	--	pF
Output Capacitance	C_{oss}		--	457	--	
Reverse Transfer Capacitance	C_{rss}		--	24	--	
Total Gate Charge	Q_g	$V_{DD} = 50V,$ $I_D = 20A,$ $V_{GS} = 10V$	--	18	--	nC
Gate-Source Charge	Q_{gs}		--	6	--	
Gate-Drain Charge	Q_{gd}		--	3.8	--	
Turn-on Delay Time	$t_{d(on)}$	$V_{DD} = 50V,$ $I_D = 20A,$ $R_G = 1.6\Omega$	--	8	--	ns
Turn-on Rise Time	t_r		--	14	--	
Turn-off Delay Time	$t_{d(off)}$		--	12	--	
Turn-off Fall Time	t_f		--	3	--	
Drain-Source Body Diode Characteristics						
Continuous Body Diode Current	I_S	$T_C = 25^\circ\text{C}$	--	--	60	A
Body Diode Voltage	V_{SD}	$T_J = 25^\circ\text{C}, I_{SD} = 20A, V_{GS} = 0V$	--	--	1.2	V
Reverse Recovery Charge	Q_{rr}	$I_F = 20A, V_{GS} = 0V$ $di/dt=500A/us$	--	128	--	nC
Reverse Recovery Time	T_{rr}		--	24	--	ns

Notes

1. Repetitive Rating: Pulse width limited by maximum junction temperature
2. EAS condition : $T_J=25^\circ\text{C}$, $V_{DD}=50V, V_{GS}=10V, L=0.5mH, R_g=25\Omega$
3. Identical low side and high side switch with identical R_G

Gate Charge Test Circuit



Switch Time Test Circuit



EAS Test Circuit



Typical Characteristics $T_J = 25^\circ\text{C}$, unless otherwise noted

Figure 1. Output Characteristics

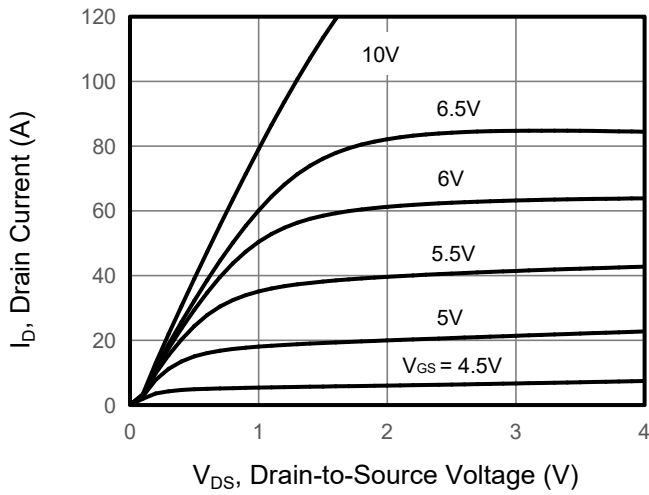

Figure 2. Transfer Characteristics

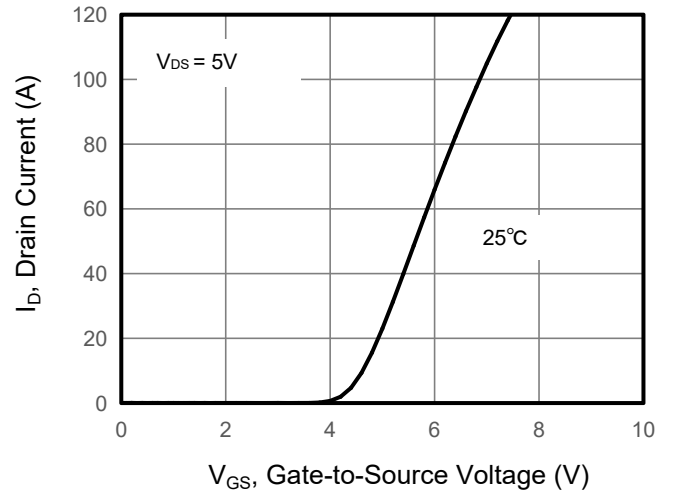

Figure 3. Drain Source On Resistance

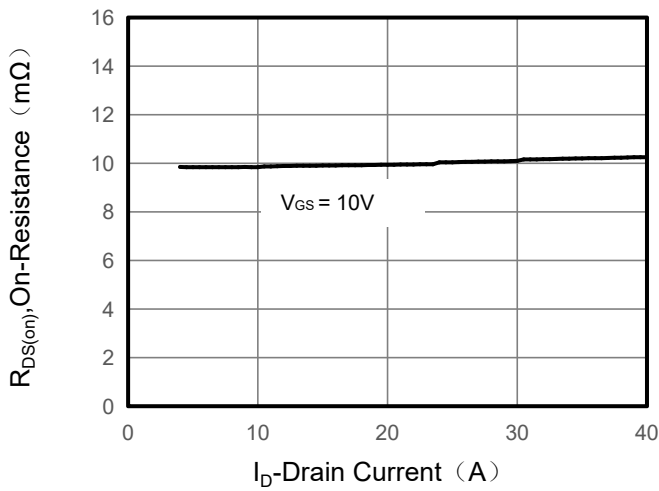

Figure 4. Gate Charge

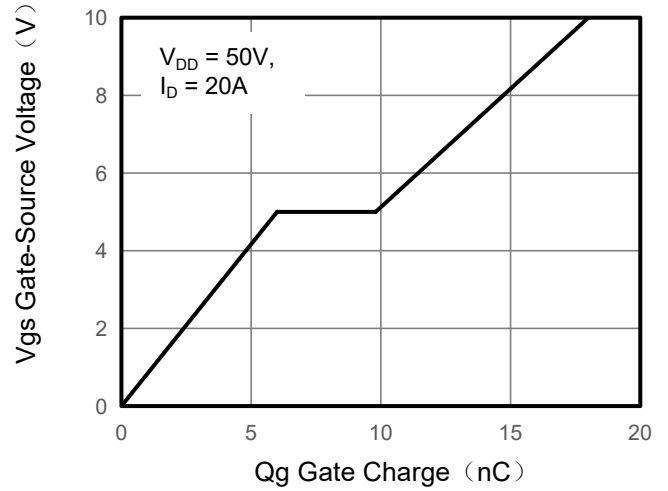

Figure 5. Capacitance

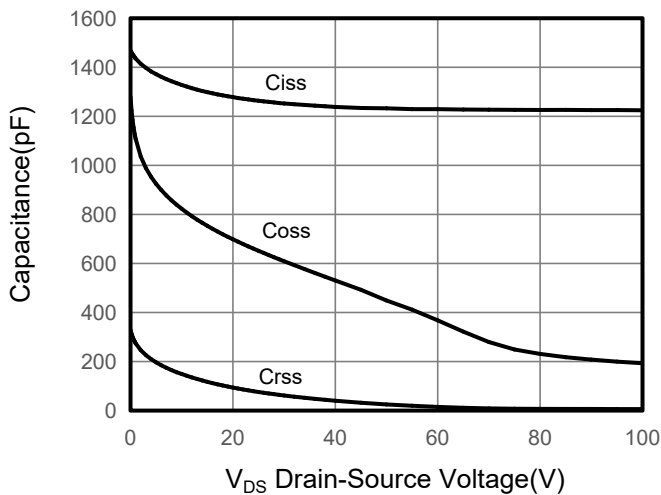
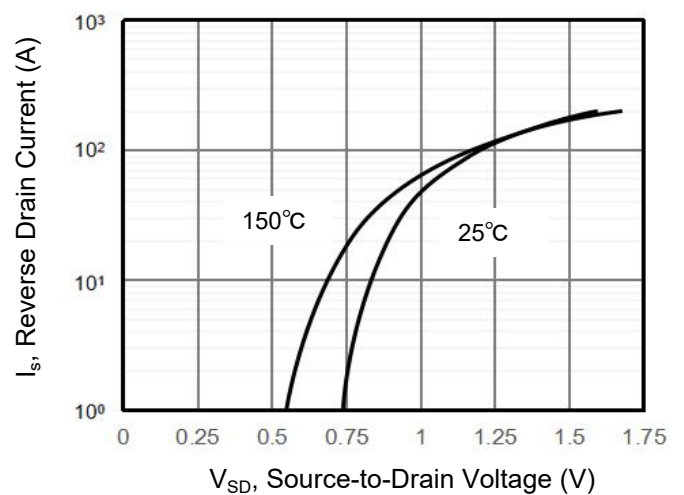

Figure 6. Source-Drain Diode Forward



Typical Characteristics $T_J = 25^\circ\text{C}$, unless otherwise noted

Figure 7. Drain-Source On-Resistance

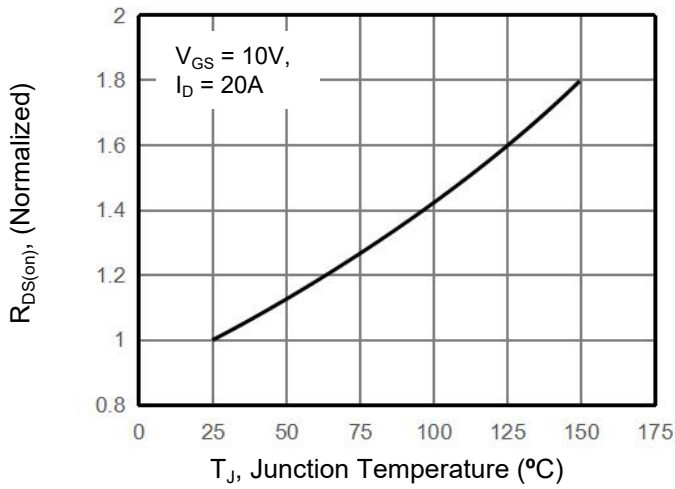

Figure 8. Safe Operation Area

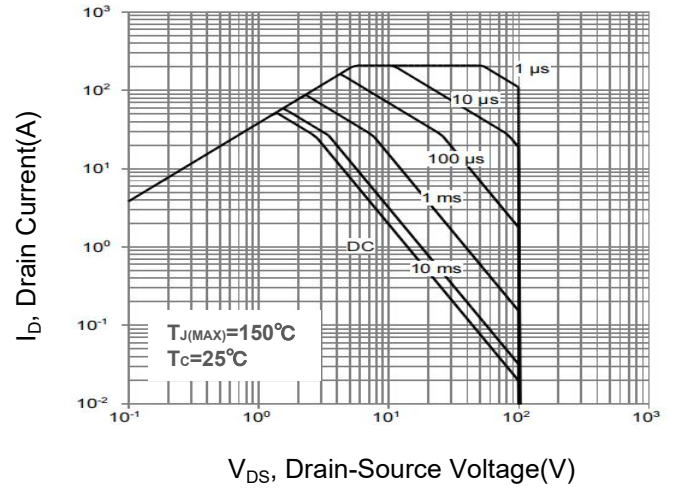
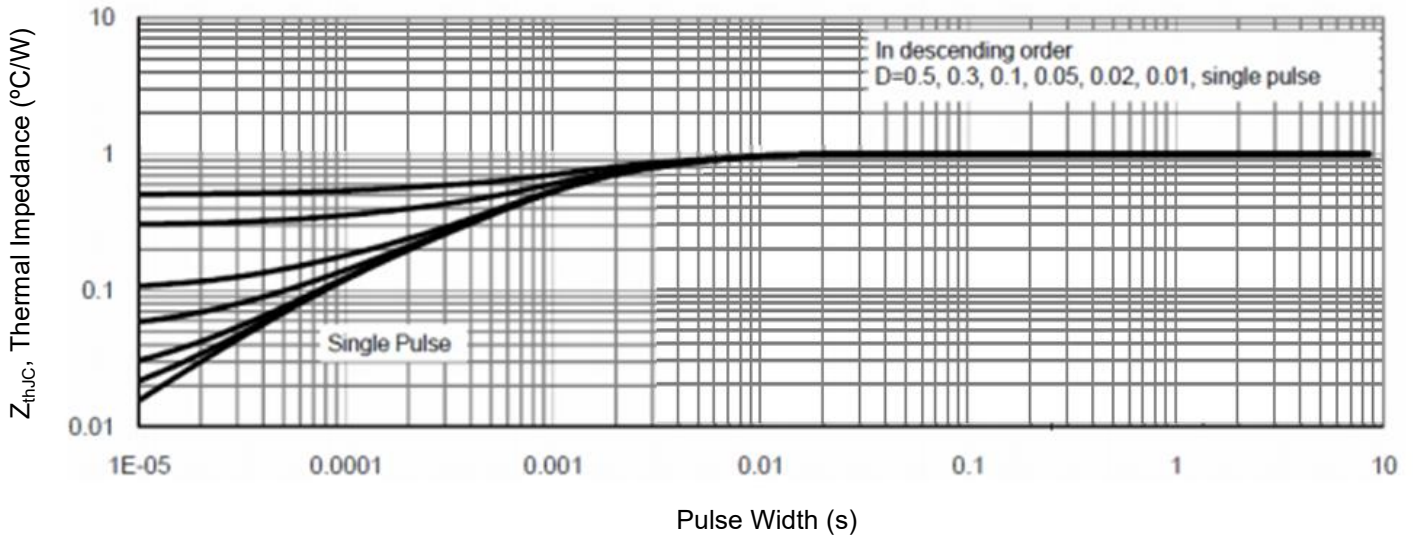
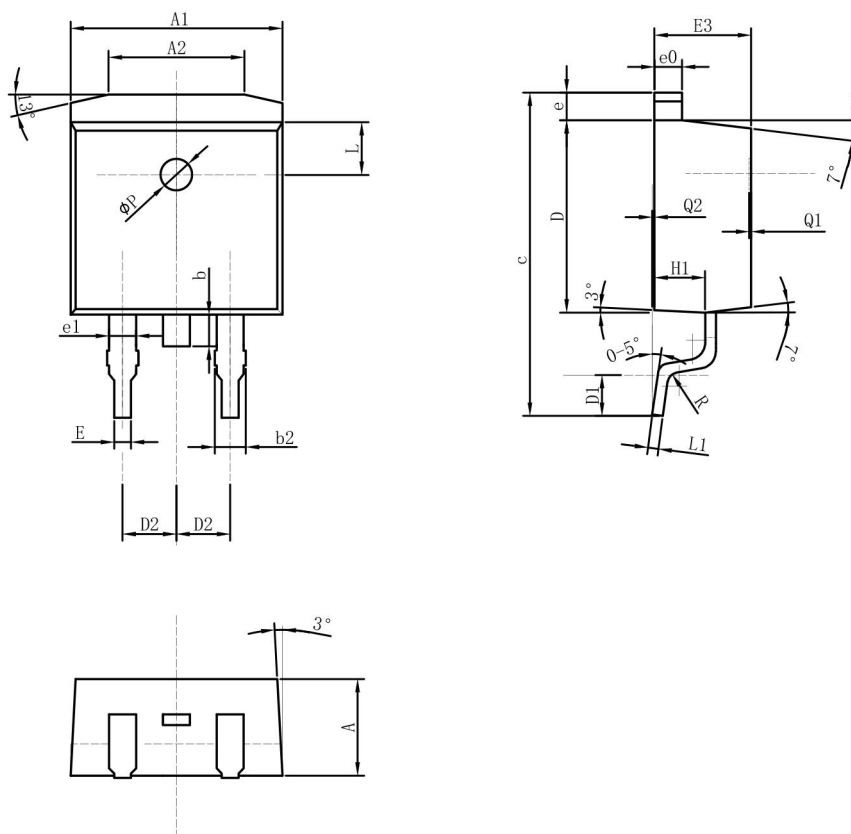

Figure 9. Normalized Maximum Transient Thermal Impedance



TO-263 Package Information



COMMON DIMENSIONS

SYMBOL	mm		
	MIN	NOM	MAX
A	4.52	4.57	4.62
A1	9.95	10.00	10.05
A2	6.30	6.40	6.50
b	1.30	1.50	1.70
b2	1.17	1.27	1.37
c	14.80	15.00	15.20
D	9.05	9.10	9.15
D1	1.90	2.10	2.30
D2	-	2.54	-
E	-	0.80	-
E3	-	4.57	-
e	-	1.30	-
e0	-	1.30	-
e1	1.73	3	-
H1	-	2.40	-
L	-	2.50	-
L1	-	0.50	-
ϕP	-	1.50	-
R	-	0.50	-
Q1	0.10	-	0.15
Q2	0	-	0.02