

# HDP26-24-9PN ✓ ACTIVE

DEUTSCH | DEUTSCH HD, DEUTSCH HDP

TE Internal #: HDP26-24-9PN

Housing for Male Terminals, Wire-to-Wire, 9 Position, Sealable, Black, Wire & Cable, Power & Signal, Cable Mount (Free-Hanging), Hybrid

[View on TE.com >](#)



Connectors > Automotive Connectors > Automotive Housings > DEUTSCH HDP20 Housings



Connector & Housing Type: **Housing for Male Terminals**

Mating Pin Diameter: 2.39 mm, 3.61 mm, 5.72 mm [ .094 in, .142 in, .225 in ]

Connector System: **Wire-to-Wire**

Number of Positions: **9**

Sealable: **Yes**

[All DEUTSCH HDP20 Housings \(324\)](#)

## Features

### Product Type Features

Connector Shape	Circular
Connector & Housing Type	Housing for Male Terminals
Connector System	Wire-to-Wire
Sealable	Yes
Hybrid Connector	Yes
Primary Locking Feature	Contact Retainer
Connector & Contact Terminates To	Wire & Cable

### Configuration Features

Blank Cavity Position	0
Connector Seal Code	N Seal
Number of Positions	9

### Electrical Characteristics

Operating Voltage	250 VAC
Nominal Voltage Architecture	12 V, 24 V, 48 V

### Body Features

Cable Exit Angle	180°
Primary Product Color	Black



### Contact Features

Contact Size	Size 12, Size 4, Size 8
Contact Type	Pin
Mating Pin Diameter	2.39 mm, 3.61 mm, 5.72 mm [.094 in][.142 in][.225 in]
Contact Current Rating (Max)	25 A, 60 A, 100 A

### Mechanical Attachment

Terminal Position Assurance	No
Strain Relief	Add By Accessory
Mating Alignment Type	Guide Slot
Mating Alignment	With
Connector Mounting Type	Cable Mount (Free-Hanging)

### Housing Features

Housing Material	PA GF
------------------	-------

### Dimensions

Connector Height	49.53 mm[1.95 in]
Product Width	49.53 mm[1.95 in]
Product Length	38.63 mm[1.521 in]
Accepts Insulation Diameter Range	3.4 – 4.32 mm, 4.83 – 6.1 mm, 7.11 – 7.42 mm [.134 – .17 in][.19 – .24 in][.28 – .292 in]

### Usage Conditions

Operating Temperature (Max)	125 °C[257 °F]
Operating Temperature Range	-55 – 125 °C[-67 – 257 °F]

### Operation/Application

Circuit Application	Power & Signal
---------------------	----------------

### Industry Standards

Degree of Protection	IP67
UL Flammability Rating	20mm Flame Test per Standard UL-94

### Packaging Features

Packaging Method	Box
------------------	-----

### Other

Serviceable	Yes
-------------	-----



Connector Position Assurance Capable

No

### Product Compliance

[For compliance documentation, visit the product page on TE.com>](#)

EU RoHS Directive 2011/65/EU	Compliant
EU ELV Directive 2000/53/EC	Compliant
China RoHS 2 Directive MIIT Order No 32, 2016	No Restricted Materials Above Threshold
EU REACH Regulation (EC) No. 1907/2006	Current ECHA Candidate List: JAN 2023 (233) Candidate List Declared Against: JAN 2023 (233) Does not contain REACH SVHC
Halogen Content	Not Low Halogen - contains Br or Cl > 900 ppm.
Solder Process Capability	Not reviewed for solder process capability

#### Product Compliance Disclaimer

This information is provided based on reasonable inquiry of our suppliers and represents our current actual knowledge based on the information they provided. This information is subject to change. The part numbers that TE has identified as EU RoHS compliant have a maximum concentration of 0.1% by weight in homogenous materials for lead, hexavalent chromium, mercury, PBB, PBDE, DBP, BBP, DEHP, DIBP, and 0.01% for cadmium, or qualify for an exemption to these limits as defined in the Annexes of Directive 2011/65/EU (RoHS2). Finished electrical and electronic equipment products will be CE marked as required by Directive 2011/65/EU. Components may not be CE marked. Additionally, the part numbers that TE has identified as EU ELV compliant have a maximum concentration of 0.1% by weight in homogenous materials for lead, hexavalent chromium, and mercury, and 0.01% for cadmium, or qualify for an exemption to these limits as defined in the Annexes of Directive 2000/53/EC (ELV). Regarding the REACH Regulation, the information TE provides on SVHC in articles for this part number is based on the latest European Chemicals Agency (ECHA) 'Guidance on requirements for substances in articles' posted at this URL: <https://echa.europa.eu/guidance-documents/guidance-on-reach>

### Compatible Parts



TE Part # CAT-D48-SP729  
DEUTSCH Sealing Plugs



TE Part # CAT-D48-ST273  
DEUTSCH Solid Contacts



TE Part # 114008-ZZ  
EXT TOOL, SIZE 8, 8-10 AWG, N, GRN



TE Part # 114010-ZZ  
EXT TOOL, SIZE 12, 12 AWG, N, YEL



TE Part # HD30-24BT  
BOOT, 24SZ, ST, GRY



TE Part # CAT-H3930-B128  
DEUTSCH HD30 Backshells



TE Part # CAT-H396-CH8172  
DEUTSCH HDP20 Housings



TE Part # 114009-ZZ  
EXT TOOL, SIZE 4, 6 AWG, N, WHT



TE Part # HD30-24BT-BK  
BOOT, 24SZ, ST, BLK

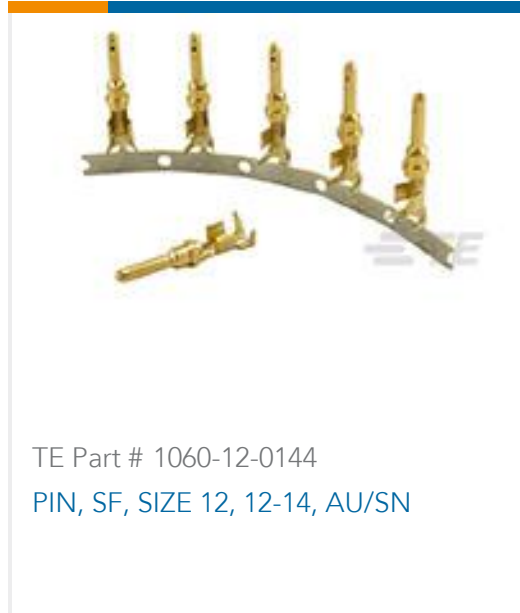

TE Part # 1060-12-0144  
PIN, SF, SIZE 12, 12-14, AU/SN



TE Part # 1060-12-0222  
PIN, SF, SIZE 12, 10, NI/NI



TE Part # 1060-12-0166  
PIN, SF, SIZE 12, 12-14, NI/SN



TE Part # HD30-24BT-90-BK  
BOOT, 24SZ, RA, BLK

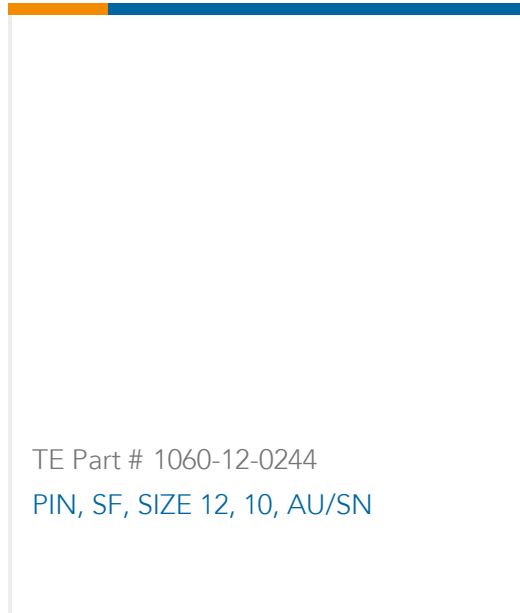

TE Part # 1060-12-0244  
PIN, SF, SIZE 12, 10, AU/SN

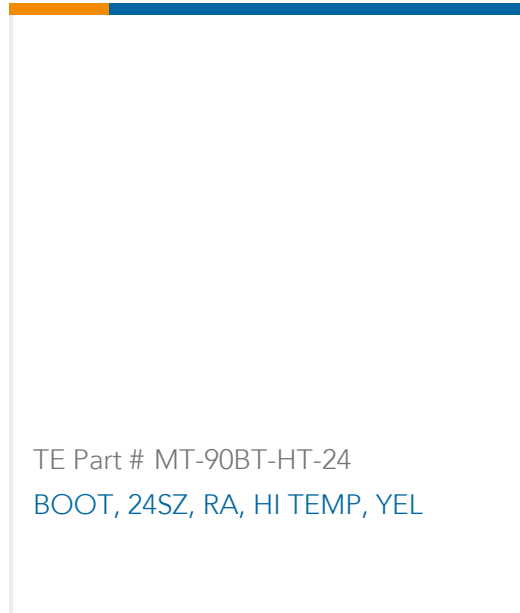

TE Part # MT-90BT-HT-24  
BOOT, 24SZ, RA, HI TEMP, YEL

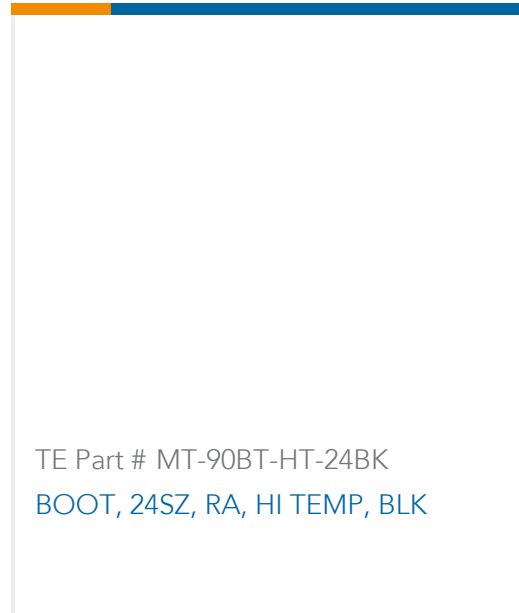

TE Part # MT-90BT-HT-24BK  
BOOT, 24SZ, RA, HI TEMP, BLK

Also in the Series | **DEUTSCH HD**



Automotive Connector Caps & Covers  
(65)

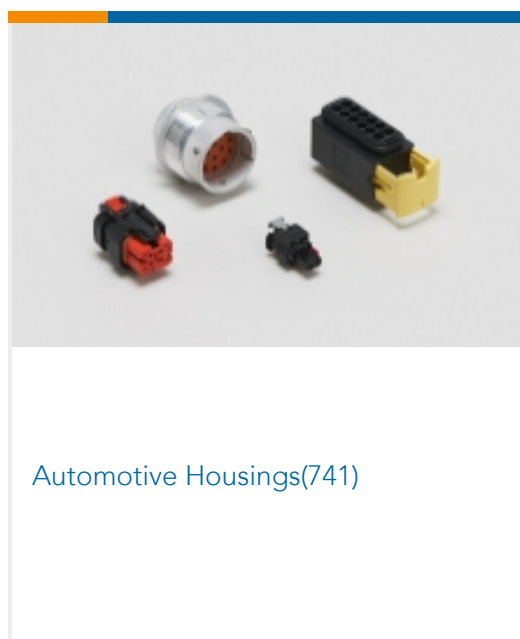

Automotive Housings(741)



Automotive Seals & Cavity Plugs(10)

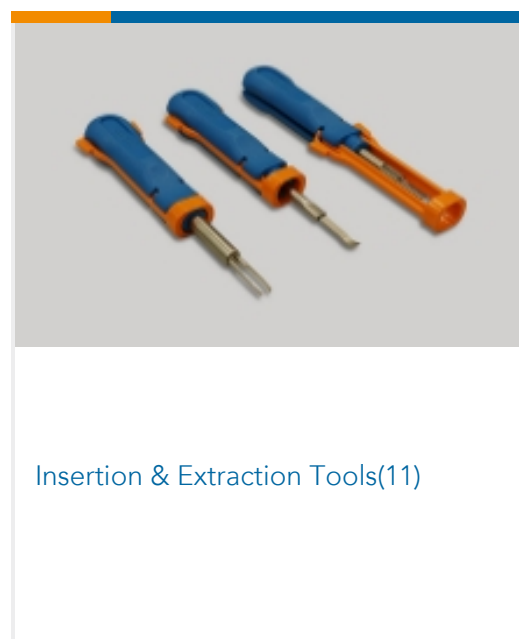

Insertion & Extraction Tools(11)

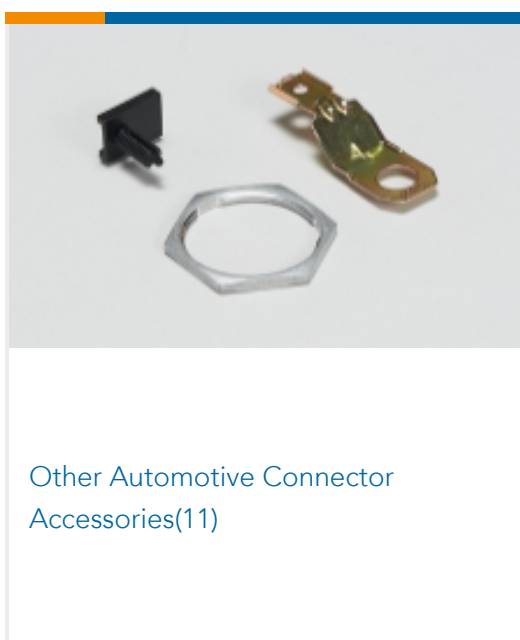

Other Automotive Connector  
Accessories(11)



PCB Headers & Receptacles(1)

Also in the Series | **DEUTSCH HDP**





Automotive Connector Caps & Covers (12)



Automotive Housings(331)



Automotive Seals & Cavity Plugs(1)



Insertion & Extraction Tools(11)



Other Automotive Connector Accessories(5)

### Customers Also Bought



TE Part #DRB12-128PAE-L018  
DEUTSCH DRB Housings



TE Part #HDP26-24-31PT  
DEUTSCH HDP20 Housings

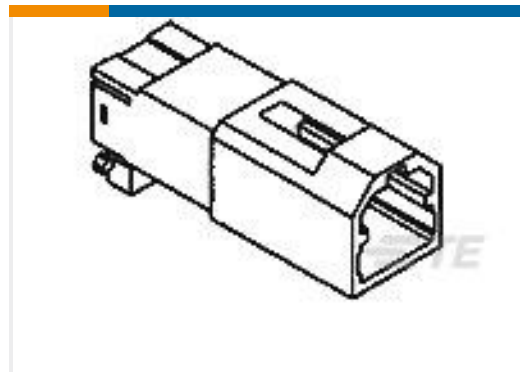

TE Part #174057-4  
040 MLC CAP HSG 2P GREEN



TE Part #8-1419111-2  
PT570060



TE Part #282684-1  
SPLASH PR.ASSY W.SEC.LOCK2W TY



TE Part #695828-000  
SLT-12X



TE Part #5428154001  
LSTT-19-0-SP



TE Part #185402-1  
MODULAR RELAY HOLDER

### Documents

#### Product Drawings

PLG, 9P, BLK, N, 4/8/12, P

English

#### CAD Files

3D PDF

3D

Customer View Model

ENG\_CVM\_CVM\_HDP26-24-9PN\_C.2d\_dxf.zip



English

**Customer View Model**

[ENG\\_CVM\\_CVM\\_HDP26-24-9PN\\_C.3d\\_igs.zip](#)

English

**Customer View Model**

[ENG\\_CVM\\_CVM\\_HDP26-24-9PN\\_C.3d\\_stp.zip](#)

English

By downloading the CAD file I accept and agree to the [Terms and Conditions](#) of use.

---

**Datasheets & Catalog Pages**

[ICT Terminals and Connectors Catalogue](#)

English

[CONNECTOR SELECTOR](#)

English

---

**Product Specifications**

[Application Specification](#)

English

---

**Agency Approvals**

[UL Report](#)

English