



NT1189GDAE3S

3.3 GHz to 5.0 GHz High Linearity Low Noise Amplifier

FEATURES

- Frequency range: 3.3 GHz to 5.0 GHz
- Supply voltage: 3.3 V to 5.5 V (5.0 V typ.)
- Operating current: 50 mA typ.
- Gain: 26 dB typ. @ n77, n78
21 dB typ. @ n79
- NF: 0.48 dB typ. @ n77, n78
0.63 dB typ. @ n79
- P-1dB(OUT): +19 dBm typ. @ n77, n78
+19 dBm typ. @ n79
- OIP3: +37dBm typ. @ n77, n78
+37dBm typ. @ n79
- Package size: 1.6 x 1.6 x 0.397 mm³ typ.
- RoHS compliant and Halogen Free, MSL1

GENERAL DESCRIPTION

The NT1189 is a high linearity low noise amplifier (LNA) from 3.3 GHz to 5.0 GHz, suitable for 5G (Sub-6GHz) base station applications.

The LNA features high gain, low noise figure (NF) and high OIP3. It supports 5G (Sub-6GHz) n77, n78 and n79 by modifying the external matching circuit. The stand-by function contributes to reduce current consumption.

The LNA achieves compact mounting area by small size package DFN1616-6-GD.

APPLICATIONS

- 5G Base Station (Macro Cell, Small Cell), CPE
- Local 5G
- DAS (Distributed Antenna System)

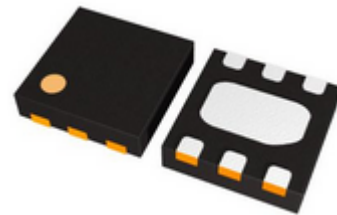

DFN1616-6-GD
1.6 x 1.6 x 0.397 (mm)

BLOCK DIAGRAM

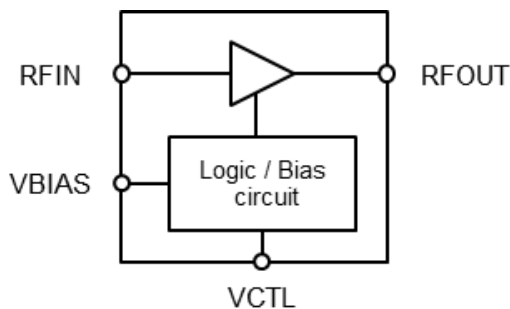

■ PRODUCT NAME INFORMATION

NT1189 GD A E3 S

Description of configuration

Suffix	Parameter	Description
GD	Package code	Indicates the package. Refer to the order information.
A	Version	Indicates the product version. "A" is initial version.
E3	Packing	Refer to the packing specifications.
S	Grade	Indicates the quality grade. "S" means general-purpose and consumer application. Operating temperature range: -40°C to +105°C, Test temperature: +25°C

■ ORDER INFORMATION

PRODUCT NAME	PACKAGE	RoHS	HALOGEN-FREE	PLATING COMPOSITION	MARKING	WEIGHT (mg)	Quantity per Reel (pcs)
NT1189GDAE3S	DFN1616-6-GD	Yes	Yes	SnBi	1189A	3.5	3000

■ PIN DESCRIPTIONS

(Top View)

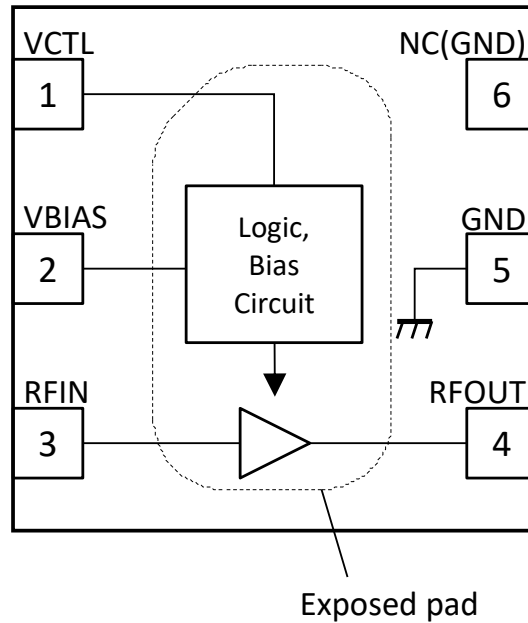

DFN1616-6-GD Pin Configuration

Pin No.	Pin Name	Description
1	VCTL	Control voltage input terminal
2	VBIAS	Bias voltage output terminal
3	RFIN	RF input terminal
4	RFOUT	RF output and voltage supply terminal
5	GND	Ground terminal
6	NC(GND)	No connected terminal (connect to ground)
-	Exposed pad	Ground terminal

Please refer to "APPLICATION CIRCUIT" for details.

■ TRUTH TABLE

"H" = V_{CTL}(H), "L" = V_{CTL}(L)

V _{CTL}	Mode
H	Active mode
L	Stand-by mode

■ ABSOLUTE MAXIMUM RATINGS

General conditions: $T_a = +25^{\circ}\text{C}$, $Z_s = Z_l = 50\ \Omega$

Parameter	Symbol	Ratings	Unit
Supply voltage	V_{DD}	6.0	V
Control voltage	V_{CTL}	6.0	V
Input power	P_{IN}^{*1}	+23	dBm
Power dissipation	P_D^{*2}	1200	mW
Operating temperature range	T_{opr}	-40 to +105	$^{\circ}\text{C}$
Storage temperature range	T_{stg}	-55 to +150	$^{\circ}\text{C}$

*1 $V_{DD} = 5.0\ \text{V}$

*2 4-layer FR4 PCB with through-hole (101.5 x 114.5 mm), $T_j = +150^{\circ}\text{C}$

ABSOLUTE MAXIMUM RATINGS

Electronic and mechanical stress momentarily exceeded absolute maximum ratings may cause permanent damage and may degrade the lifetime and safety for both device and system using the device in the field. The functional operation at or over these absolute maximum ratings is not assured.

■ ELECTROSTATIC DISCHARGE (ESD) PROTECTION VOLTAGE

Symbol	Conditions	Protection Voltage
HBM	$C = 100\ \text{pF}$, $R = 1.5\ \text{k}\Omega$	$\pm 1000\ \text{V}$
CDM	Field Induced CDM	$\pm 1000\ \text{V}$

ESD PROTECTION VOLTAGE

The electrostatic discharge test is done based on JESD47.
In the HBM method, ESD is applied using the GND pin as reference pins.

■ RECOMMENDED OPERATING CONDITIONS

Parameter	Symbol	Value	Unit
Supply voltage	V_{DD}	3.3 to 5.5	V
Control voltage	V_{CTL}	1.3 to 5.5	V
Operating temperature range	T_a	-40 to +105	°C

RECOMMENDED OPERATING CONDITIONS

All of electronic equipment should be designed that the mounted semiconductor devices operate within the recommended operating conditions. The semiconductor devices cannot operate normally over the recommended operating conditions, even if when they are used over such conditions by momentary electronic noise or surge. And the semiconductor devices may receive serious damage when they continue to operate over the recommended operating conditions.

■ ELECTRICAL CHARACTERISTICS 1 (DC)

General conditions: $T_a = +25^{\circ}\text{C}$, $Z_s = Z_l = 50 \Omega$

Parameter	Symbol	Conditions	MIN	TYP	MAX	Unit
Supply voltage	V_{DD}		3.3	5.0	5.5	V
Control voltage (High)	$V_{CTL(H)}$		1.3	1.8	5.5	V
Control voltage (Low)	$V_{CTL(L)}$		0	0	0.3	V
Operating current	I_{DD}	RF OFF, $V_{DD} = 5.0 \text{ V}$, $V_{CTL} = 1.8 \text{ V}$	-	50	75	mA
		RF OFF, $V_{DD} = 5.0 \text{ V}$, $V_{CTL} = 0 \text{ V}$	-	0.1	0.7	mA
Control current	I_{CTL}	RF OFF, $V_{CTL} = 1.8 \text{ V}$	-	7	15	μA

■ ELECTRICAL CHARACTERISTICS 2 (RF) n77, n78

General conditions: $V_{DD} = 5.0\text{ V}$, $V_{CTL} = 1.8\text{ V}$, $f = 3300\text{ MHz to }4200\text{ MHz}$, $T_a = +25^\circ\text{C}$, $Z_s = Z_l = 50\ \Omega$, with application circuit.

Parameter	Symbol	Conditions	MIN	TYP	MAX	Unit
Small signal gain	Gain	f = 3300 MHz, Exclude PCB, connector loss (0.22 dB)	20.0	26.0	30.0	dB
		f = 3800 MHz, Exclude PCB, connector loss (0.26 dB)				
		f = 4200 MHz, Exclude PCB, connector loss (0.29 dB)				
Noise figure	NF	f = 3300 MHz, Exclude PCB, connector loss (0.09 dB)	-	0.48	0.78	dB
		f = 3800 MHz, Exclude PCB, connector loss (0.10 dB)				
		f = 4200 MHz, Exclude PCB, connector loss (0.12 dB)				
Output power at 1 dB gain compression point	P-1dB(OUT)	f = 3300 MHz	+15	+19	-	dBm
		f = 3800 MHz				
		f = 4200 MHz				
Output 3rd order intercept point	OIP3	f1 = 3300 MHz, f2 = f1 + 1 MHz, $P_{IN} = -26\text{ dBm}$	+30	+37	-	dBm
		f1 = 3800 MHz, f2 = f1 + 1 MHz, $P_{IN} = -26\text{ dBm}$				
		f1 = 4200 MHz, f2 = f1 + 1 MHz, $P_{IN} = -26\text{ dBm}$				
RFIN Return loss	RLi	f = 3300 MHz	7.0	12.0	-	dB
		f = 3800 MHz				
		f = 4200 MHz				
RFOUT Return loss	RLo	f = 3300 MHz	10.0	15.0	-	dB
		f = 3800 MHz				
		f = 4200 MHz				
Switching Time 1	T_{SW1}	Standby mode to Active mode to be within 1 dB of the final output power	-	80	300	ns
Switching Time 2	T_{SW2}	Active mode to Standby mode to be within 1 dB of the final output power	-	90	300	ns
k factor	k	f = 50 MHz to 10 GHz	1.0	-	-	-

■ ELECTRICAL CHARACTERISTICS 3 (RF) n79

General conditions: $V_{DD} = 5.0\text{ V}$, $V_{CTL} = 1.8\text{ V}$, $f = 4400\text{ MHz to }5000\text{ MHz}$, $T_a = +25^\circ\text{C}$, $Z_s = Z_l = 50\ \Omega$, with application circuit.

Parameter	Symbol	Conditions	MIN	TYP	MAX	Unit
Small signal gain	Gain	f = 4400 MHz, Exclude PCB, connector loss (0.30 dB)	-	21.0	-	dB
		f = 4700 MHz, Exclude PCB, connector loss (0.32 dB)				
		f = 5000 MHz, Exclude PCB, connector loss (0.35 dB)				
Noise figure	NF	f = 4400 MHz, Exclude PCB, connector loss (0.12 dB)	-	0.63	-	dB
		f = 4700 MHz, Exclude PCB, connector loss (0.13 dB)				
		f = 5000 MHz, Exclude PCB, connector loss (0.14 dB)				
Output power at 1 dB gain compression point	P-1dB(OUT)	f = 4400 MHz	-	+19	-	dBm
		f = 4700 MHz				
		f = 5000 MHz				
Output 3rd order intercept point	OIP3	f1 = 4400 MHz, f2 = f1 + 1 MHz, $P_{IN} = -26\text{ dBm}$	-	+37	-	dBm
		f1 = 4700 MHz, f2 = f1 + 1 MHz, $P_{IN} = -26\text{ dBm}$				
		f1 = 5000 MHz, f2 = f1 + 1 MHz, $P_{IN} = -26\text{ dBm}$				
RFIN Return loss	RLi	f = 4400 MHz	-	10.0	-	dB
		f = 4700 MHz				
		f = 5000 MHz				
RFOUT Return loss	RLo	f = 4400 MHz	-	10.0	-	dB
		f = 4700 MHz				
		f = 5000 MHz				
Switching Time 1	T_{SW1}	Standby mode to Active mode to be within 1 dB of the final output power	-	80	-	ns
Switching Time 2	T_{SW2}	Active mode to Standby mode to be within 1 dB of the final output power	-	90	-	ns
k factor	k	f = 50 MHz to 10 GHz	1.0	-	-	-

■ TYPICAL CHARACTERISTICS (n77, n78)

Conditions: $V_{DD} = 5.0\text{ V}$, $V_{CTL} = 1.8\text{ V}$, $T_a = +25^\circ\text{C}$, $Z_s = Z_l = 50\ \Omega$, with application circuit.
 (Typical Characteristics are intended to be used as reference data; they are not guaranteed.)

Gain, NF vs. Frequency

($V_{DD} = 5.0\text{ V}$, $V_{CTL} = 1.8\text{ V}$)

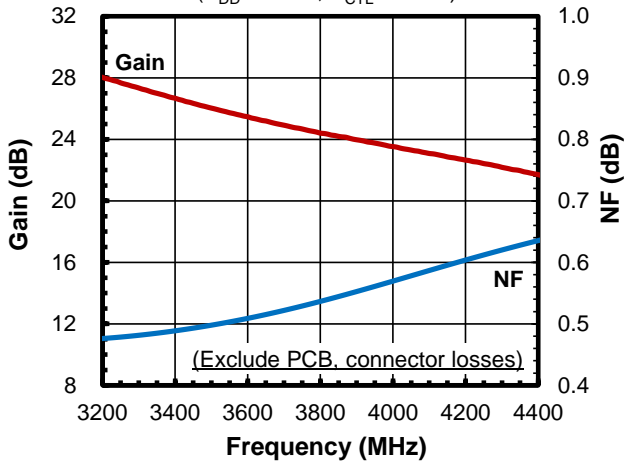

P-1dB(OUT) vs. Frequency

($V_{DD} = 5.0\text{ V}$, $V_{CTL} = 1.8\text{ V}$)

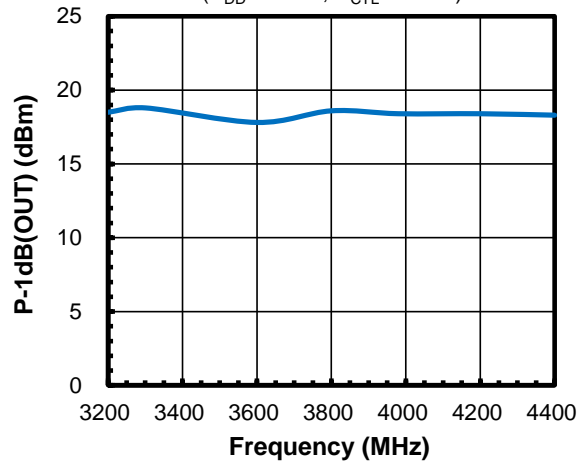

P_{OUT} vs. P_{IN}

($V_{DD} = 5.0\text{ V}$, $V_{CTL} = 1.8\text{ V}$, $f = 3800\text{ MHz}$)

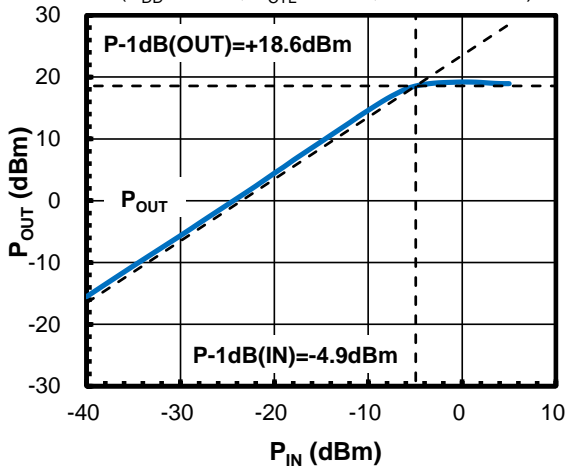

Gain, I_{DD} vs. P_{OUT}

($V_{DD} = 5.0\text{ V}$, $V_{CTL} = 1.8\text{ V}$, $f = 3800\text{ MHz}$)

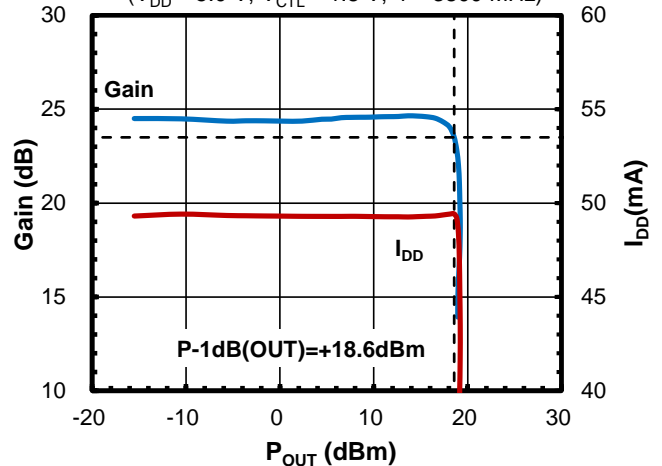

IIP3, OIP3 vs. Frequency

($V_{DD} = 5.0\text{ V}$, $V_{CTL} = 1.8\text{ V}$, $P_{in} = -26\text{ dBm}$, $f_2 = f_1 + 1\text{ MHz}$)

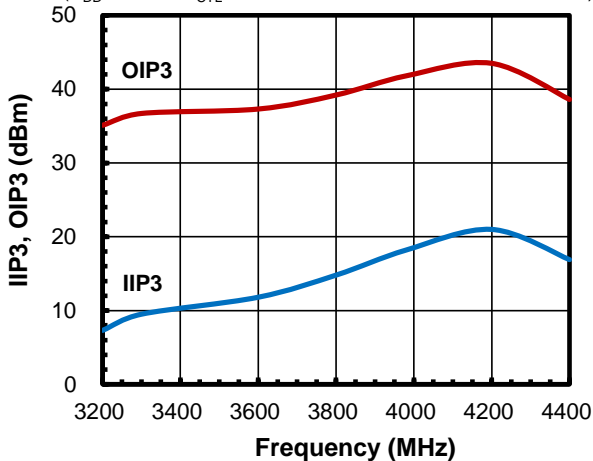

P_{OUT} , IM3 vs. P_{IN}

($V_{DD} = 5.0\text{ V}$, $V_{CTL} = 1.8\text{ V}$, $f_1 = 3800\text{ MHz}$, $f_2 = f_1 + 1\text{ MHz}$)

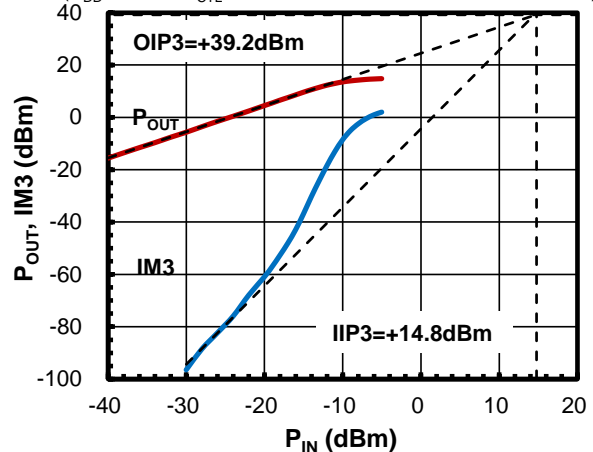

■ TYPICAL CHARACTERISTICS (n77, n78)

Conditions: $V_{DD} = 5.0\text{ V}$, $V_{CTL} = 1.8\text{ V}$, $T_a = +25^\circ\text{C}$, $Z_s = Z_l = 50\ \Omega$, with application circuit.

(Typical Characteristics are intended to be used as reference data; they are not guaranteed.)

S11 vs. Frequency

($V_{DD} = 5.0\text{ V}$, $V_{CTL} = 1.8\text{ V}$)

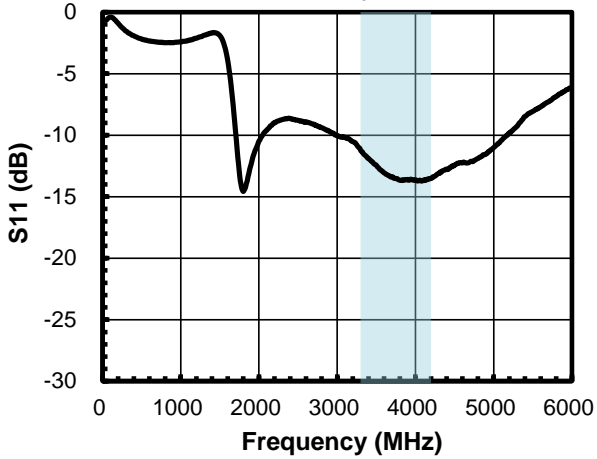

S21 vs. Frequency

($V_{DD} = 5.0\text{ V}$, $V_{CTL} = 1.8\text{ V}$)

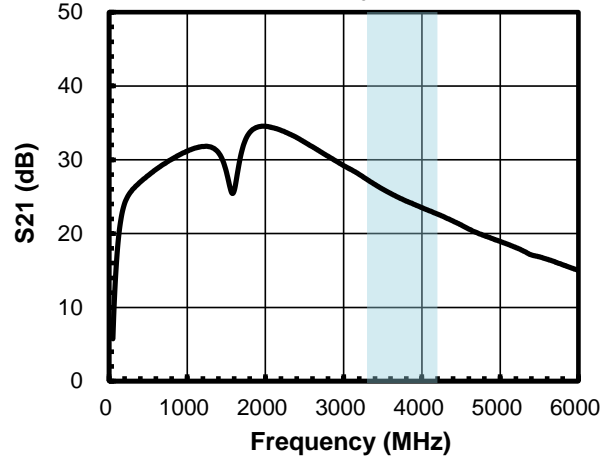

S22 vs. Frequency

($V_{DD} = 5.0\text{ V}$, $V_{CTL} = 1.8\text{ V}$)

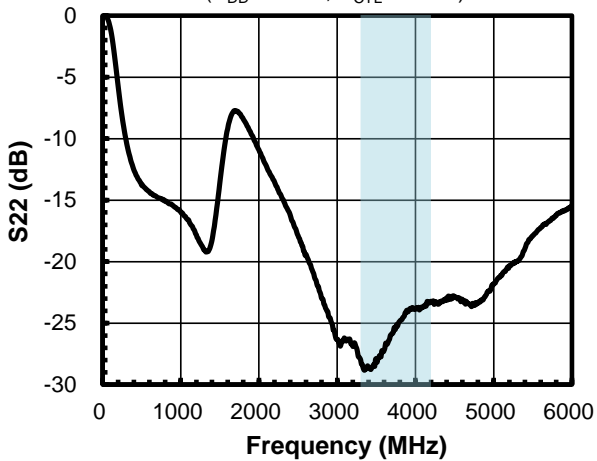

S12 vs. Frequency

($V_{DD} = 5.0\text{ V}$, $V_{CTL} = 1.8\text{ V}$)

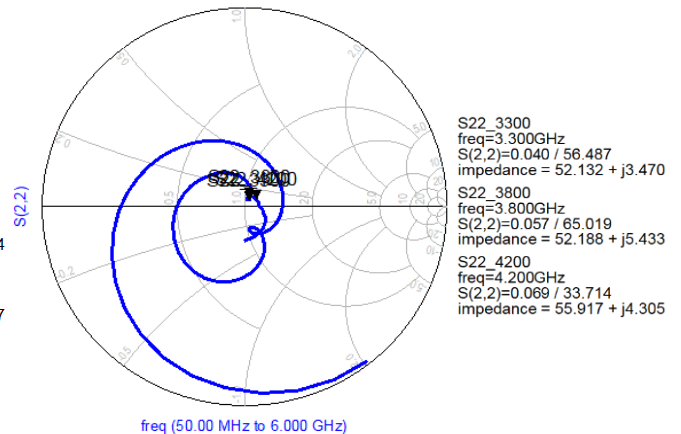
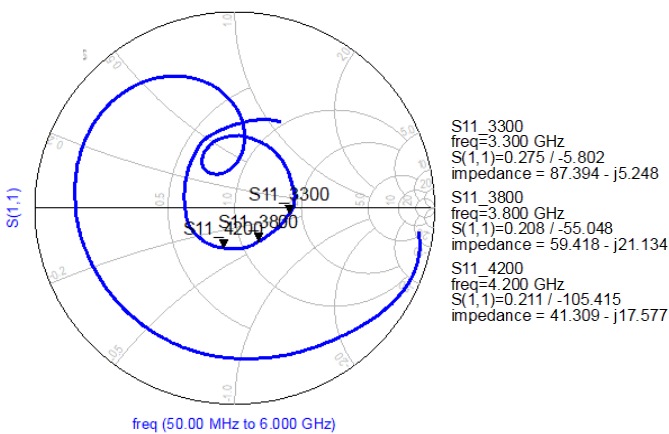
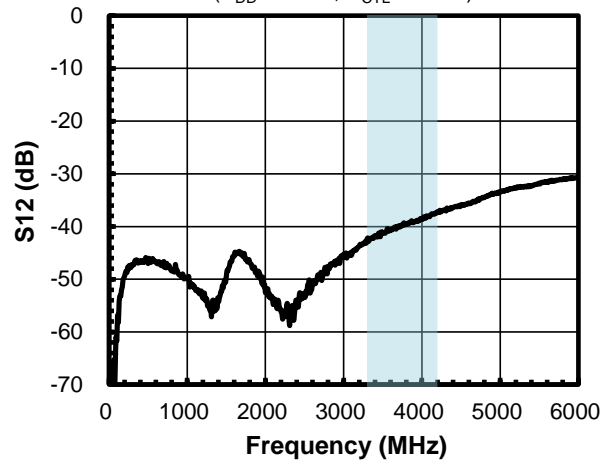

■ **TYPICAL CHARACTERISTICS** (n77, n78)

Conditions: $V_{DD} = 5.0\text{ V}$, $V_{CTL} = 1.8\text{ V}$, $T_a = +25^\circ\text{C}$, $Z_s = Z_l = 50\ \Omega$, with application circuit.

(Typical Characteristics are intended to be used as reference data; they are not guaranteed.)

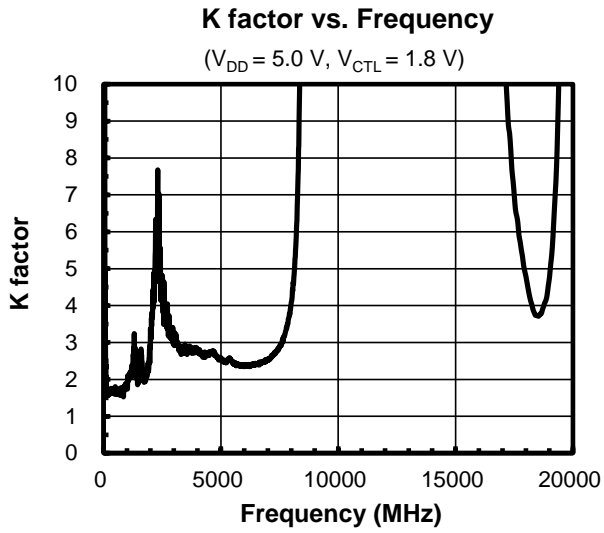

■ TYPICAL CHARACTERISTICS (n79)

Conditions: $V_{DD} = 5.0\text{ V}$, $V_{CTL} = 1.8\text{ V}$, $T_a = +25^\circ\text{C}$, $Z_s = Z_l = 50\ \Omega$, with application circuit.

(Typical Characteristics are intended to be used as reference data; they are not guaranteed.)

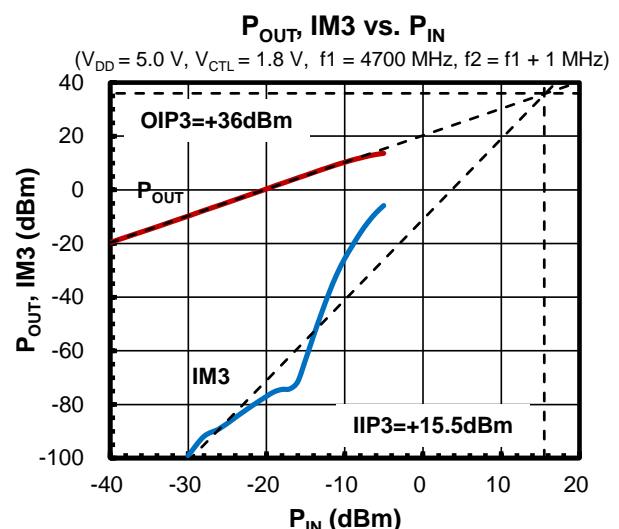
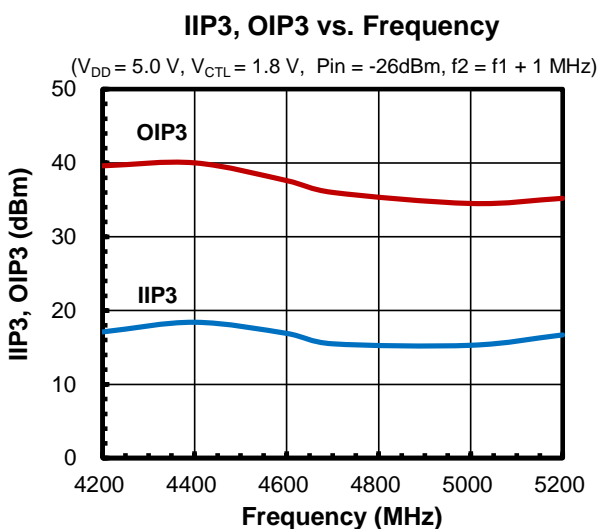
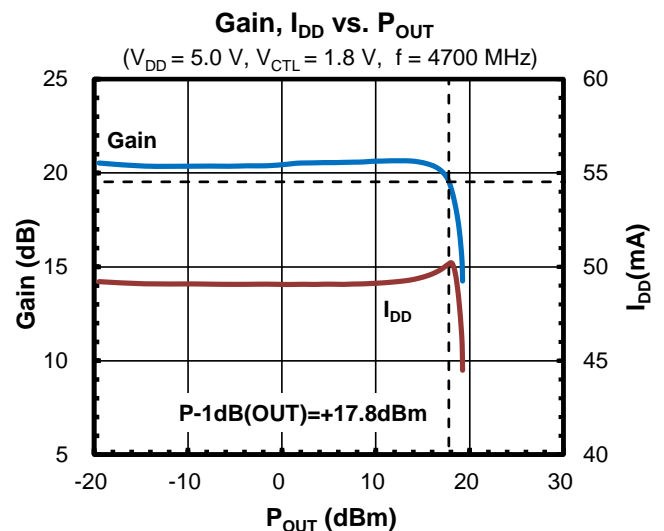
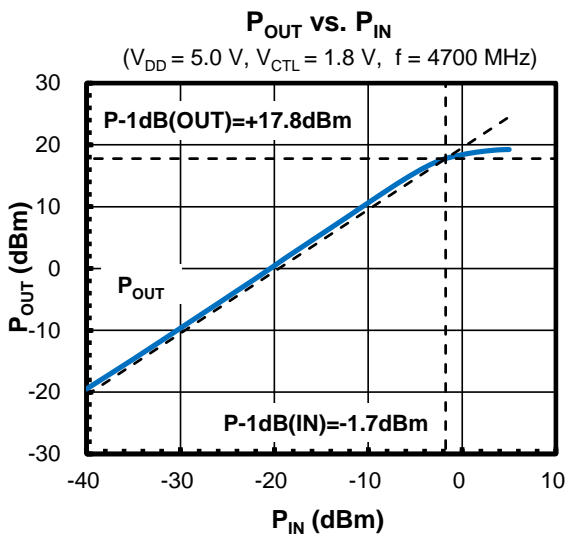
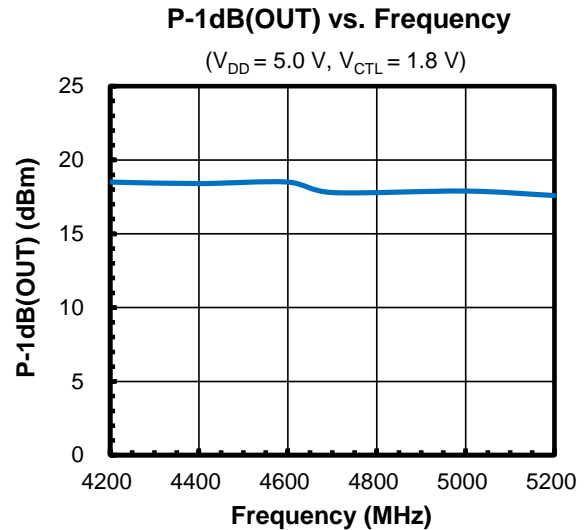
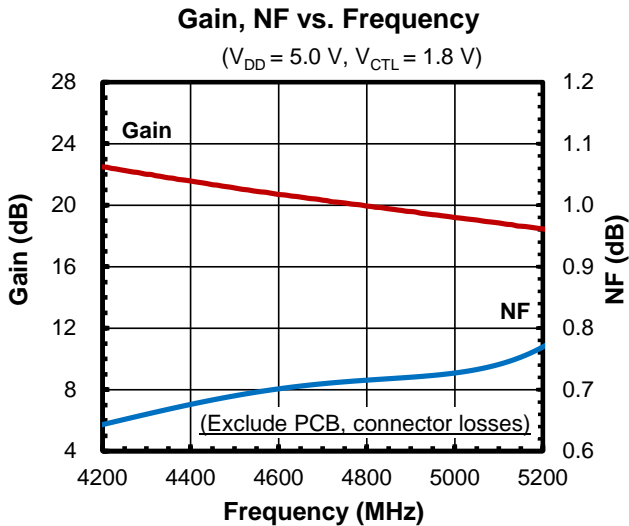

■ TYPICAL CHARACTERISTICS (n79)

Conditions: $V_{DD} = 5.0\text{ V}$, $V_{CTL} = 1.8\text{ V}$, $T_a = +25^\circ\text{C}$, $Z_s = Z_l = 50\ \Omega$, with application circuit.

(Typical Characteristics are intended to be used as reference data; they are not guaranteed.)

S11 vs. Frequency

($V_{DD} = 5.0\text{ V}$, $V_{CTL} = 1.8\text{ V}$)

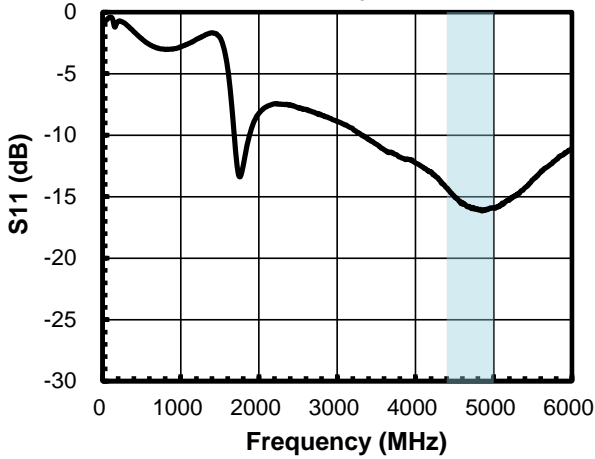

S21 vs. Frequency

($V_{DD} = 5.0\text{ V}$, $V_{CTL} = 1.8\text{ V}$)

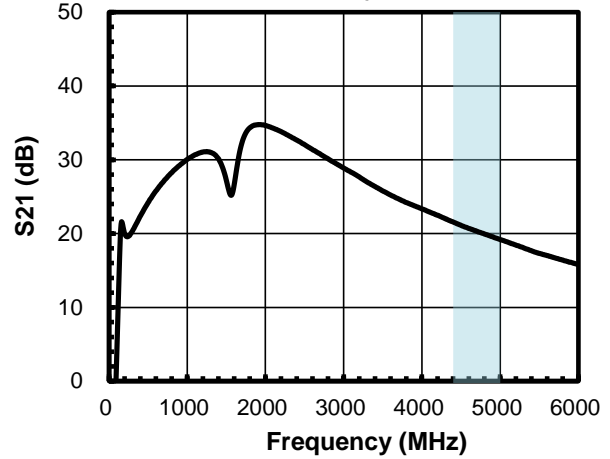

S22 vs. Frequency

($V_{DD} = 5.0\text{ V}$, $V_{CTL} = 1.8\text{ V}$)

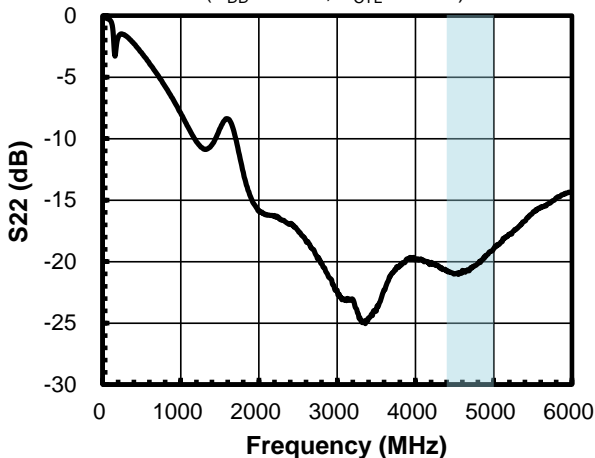

S12 vs. Frequency

($V_{DD} = 5.0\text{ V}$, $V_{CTL} = 1.8\text{ V}$)

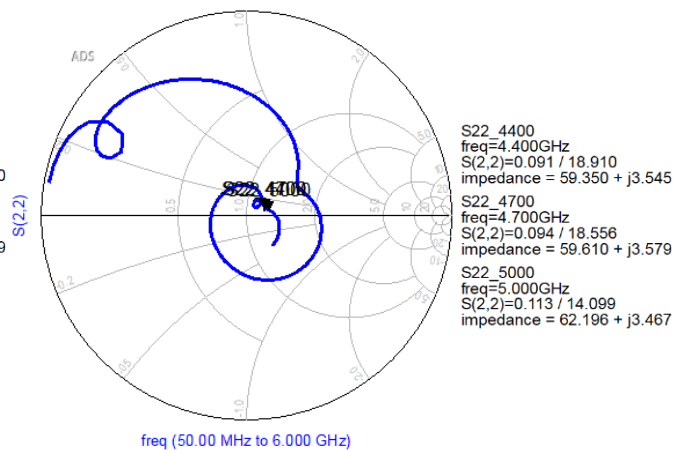
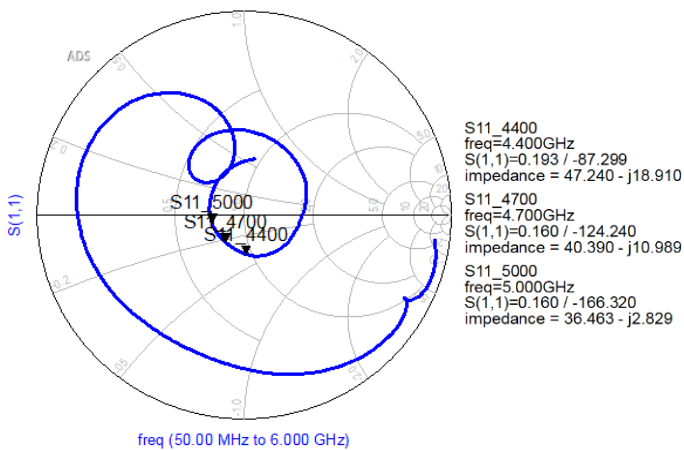
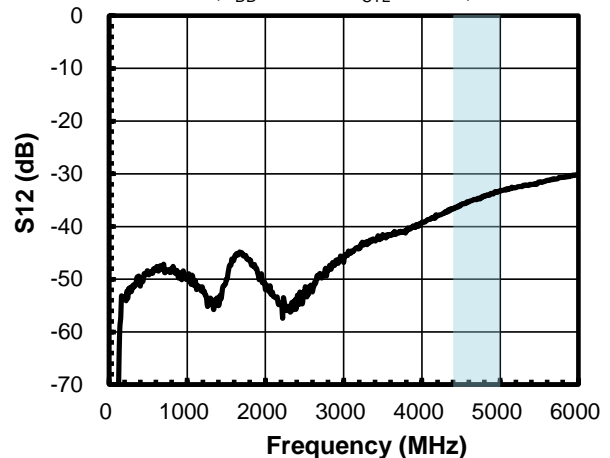

■ **TYPICAL CHARACTERISTICS** (n79)

Conditions: $V_{DD} = 1.8\text{ V}$, $V_{CTL} = 1.8\text{ V}$, $T_a = +25^\circ\text{C}$, $Z_s = Z_l = 50\ \Omega$, with application circuit.

(Typical Characteristics are intended to be used as reference data; they are not guaranteed.)

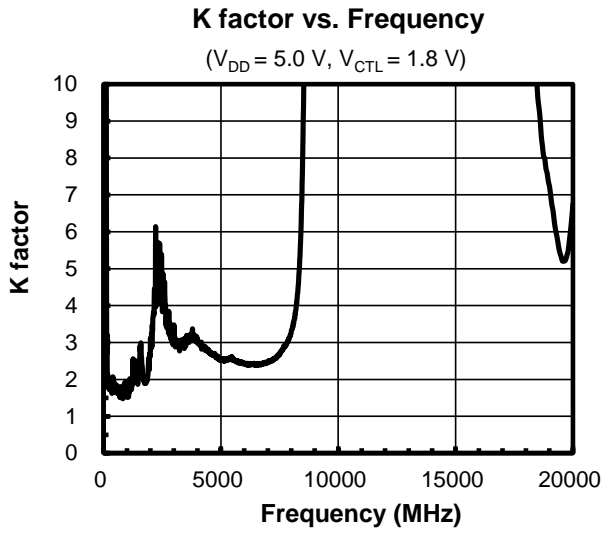

■ **TYPICAL CHARACTERISTICS** (n77, n78)

Conditions: $T_a = +25^\circ\text{C}$, $Z_s = Z_l = 50 \Omega$, with application circuit.

(Typical Characteristics are intended to be used as reference data; they are not guaranteed.)

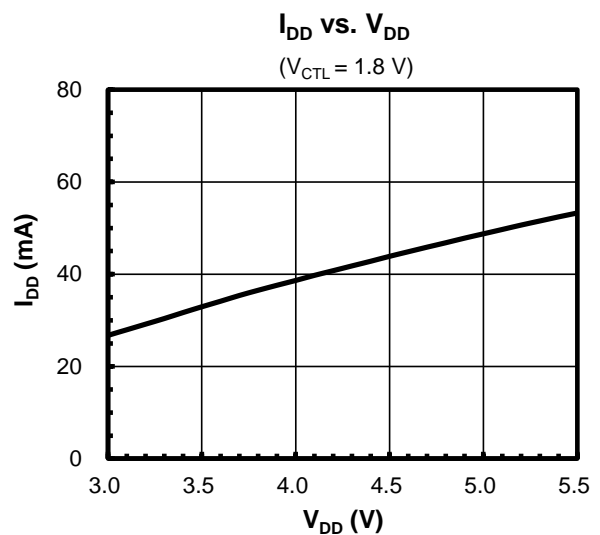
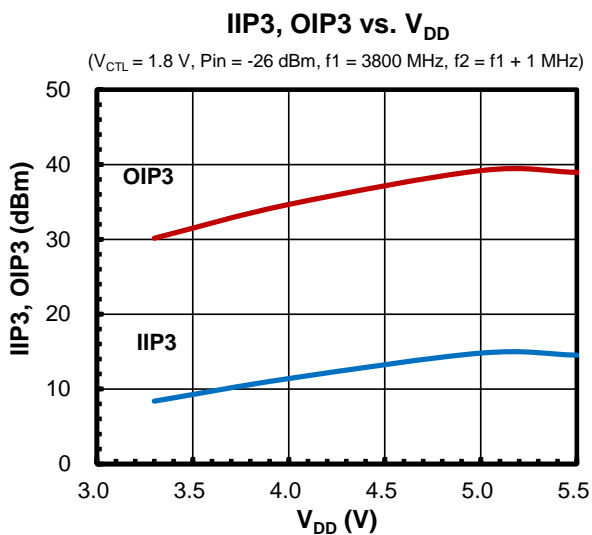
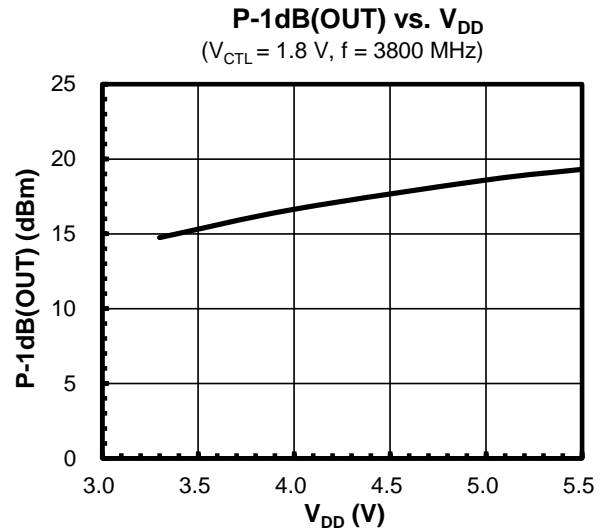
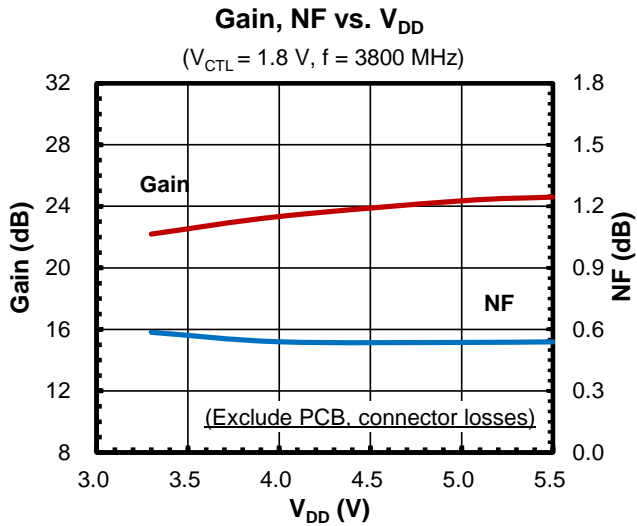

■ TYPICAL CHARACTERISTICS (n79)

Conditions: $T_a = +25^\circ\text{C}$, $Z_s = Z_l = 50 \Omega$, with application circuit.

(Typical Characteristics are intended to be used as reference data; they are not guaranteed.)

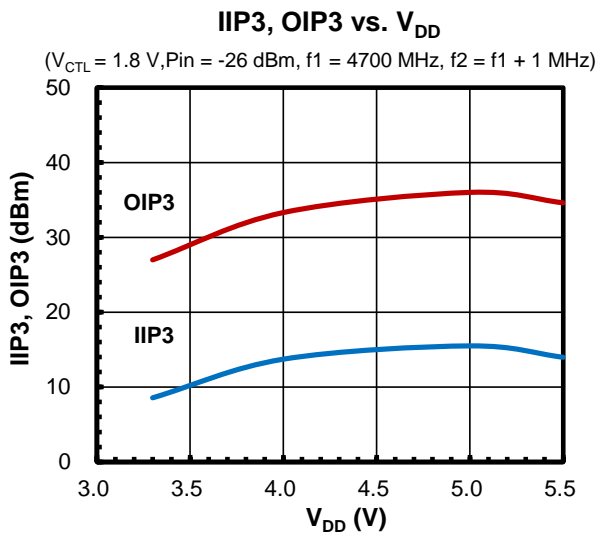
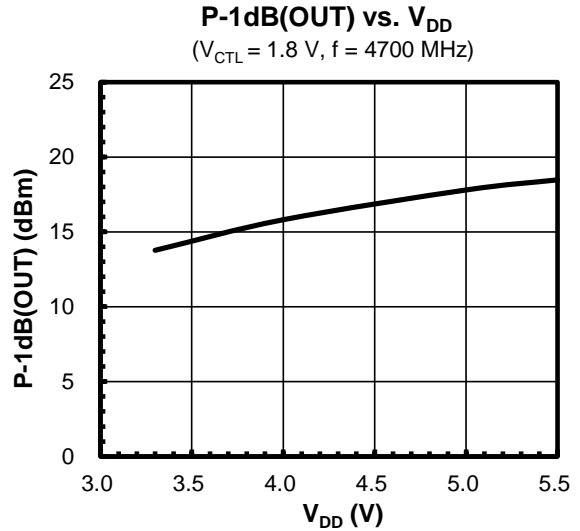
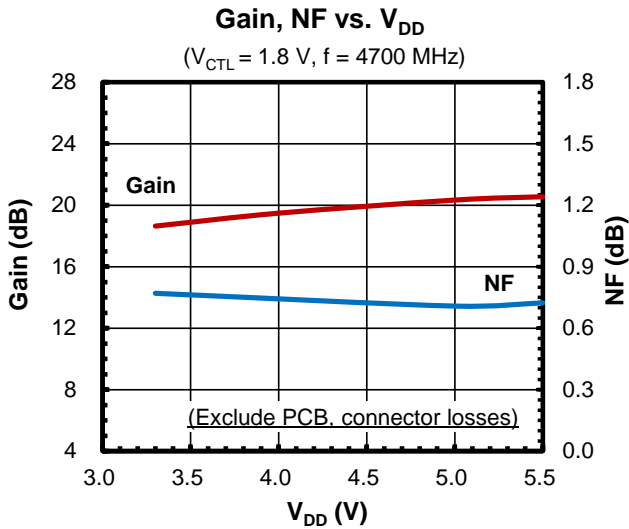

■ **TYPICAL CHARACTERISTICS** (n77, n78)

Conditions: $V_{DD} = 5.0\text{ V}$, $V_{CTL} = 1.8\text{ V}$, $Z_s = Z_l = 50\ \Omega$, with application circuit.

(Typical Characteristics are intended to be used as reference data; they are not guaranteed.)

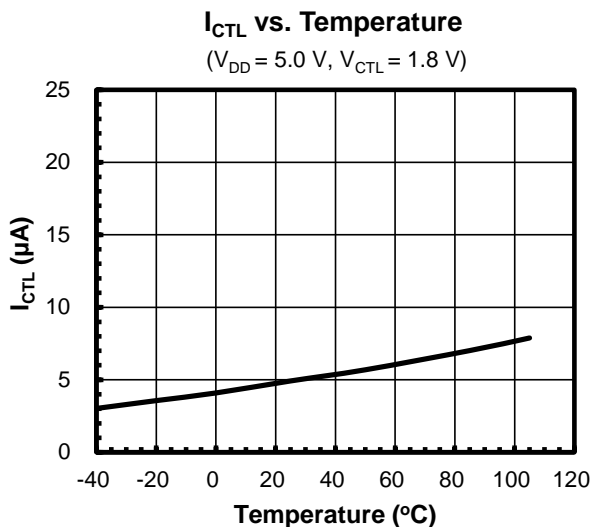
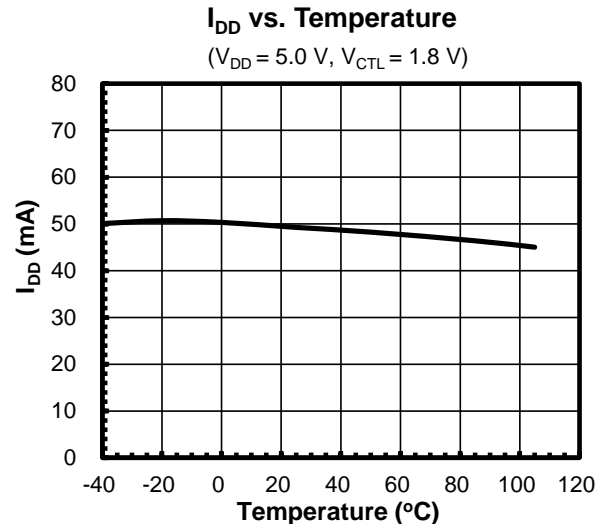
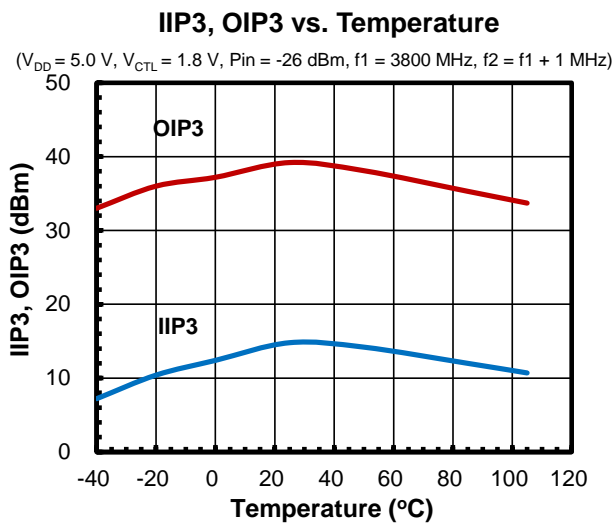
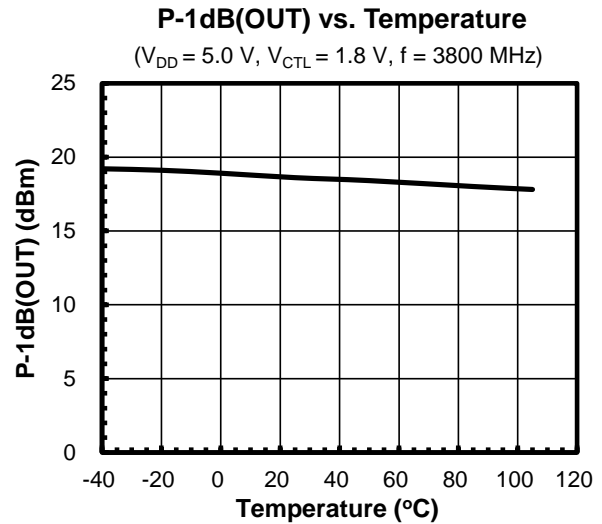
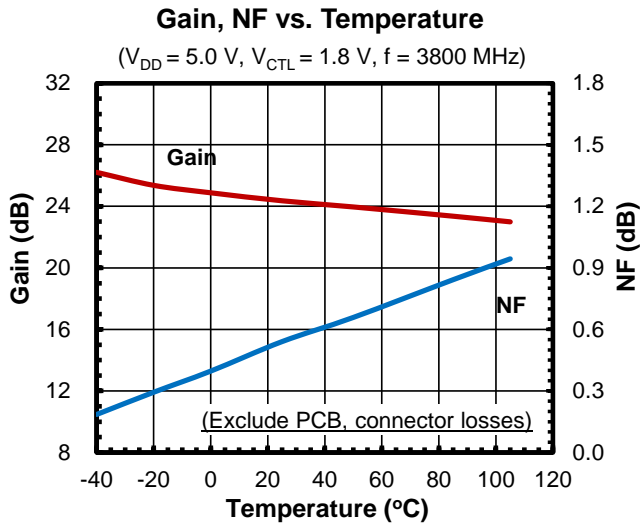

■ TYPICAL CHARACTERISTICS (n79)

Conditions: $V_{DD} = 5.0\text{ V}$, $V_{CTL} = 1.8\text{ V}$, $Z_s = Z_l = 50\ \Omega$, with application circuit.

(Typical Characteristics are intended to be used as reference data; they are not guaranteed.)

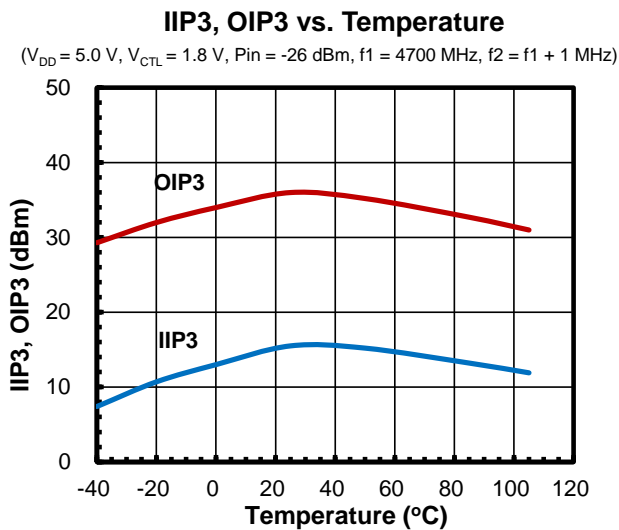
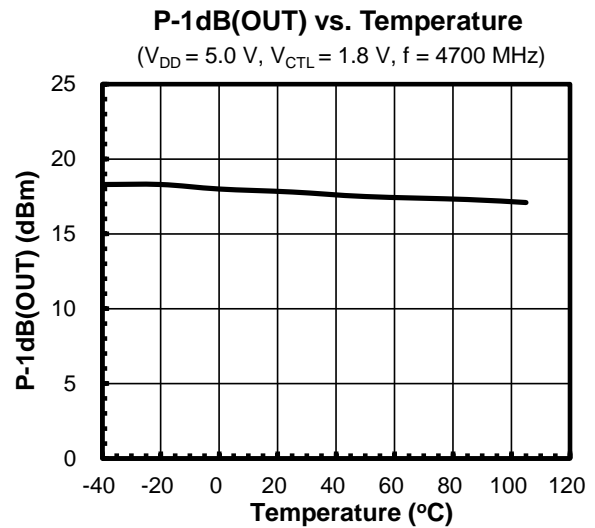
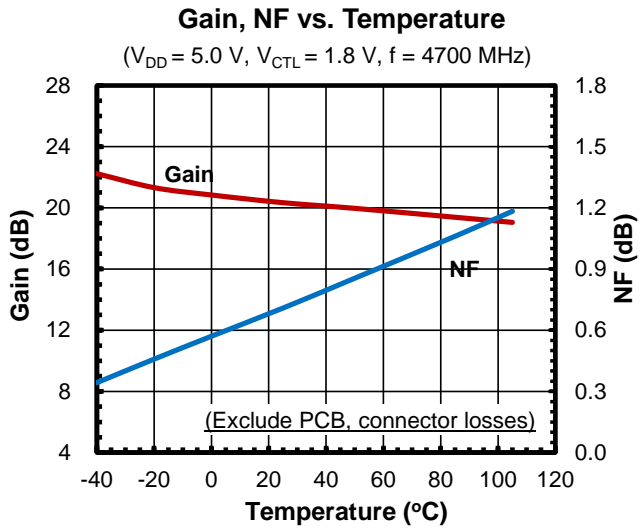

■ APPLICATION CIRCUIT

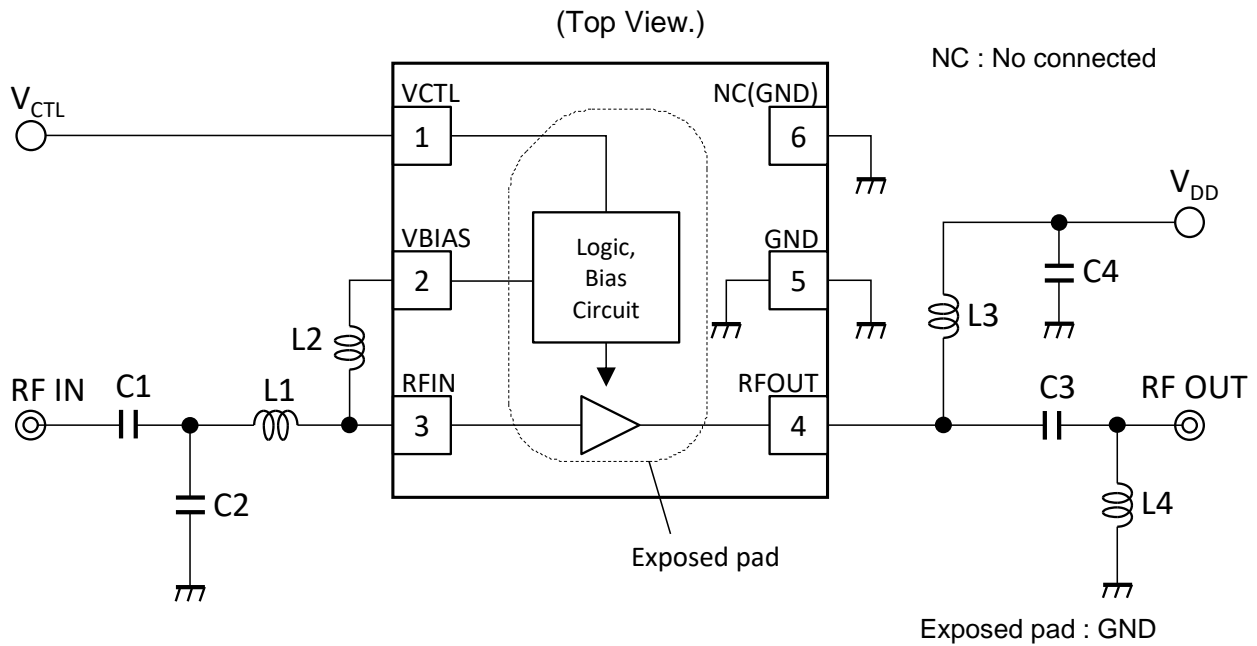

NT1189GDAE3S Application Circuit

<Parts list>

3300 to 4200 MHz (n77, n78)

Part ID	Value	Notes
L1	1.3 nH	LQW15AN_80 series (MURATA)
L2	18 nH	LQW15AN_00 series (MURATA)
L3	27 nH	LQP03TN_02 series (MURATA)
L4	--	No connected
C1	15 pF	GJM15 series (MURATA)
C2	0.5 pF	GJM15 series (MURATA)
C3	27 pF	GRM03 series (MURATA)
C4	0.1 μF	GRM03 series (MURATA)

4400 to 5000 MHz (n79)

Part ID	Value	Notes
L1	0.9 nH	LQP03HQ_02 series (MURATA)
L2	18 nH	LQW15AN_00 series (MURATA)
L3	27 nH	LQP03TN_02 series (MURATA)
L4	10 nH	LQG15HS series (MURATA)
C1	15 pF	GJM15 series (MURATA)
C2	0.4 pF	GJM15 series (MURATA)
C3	27 pF	GRM03 series (MURATA)
C4	0.1 μF	GRM03 series (MURATA)

■ APPLICATION NOTES

- Evaluation Board / PCB layout

(Top View)

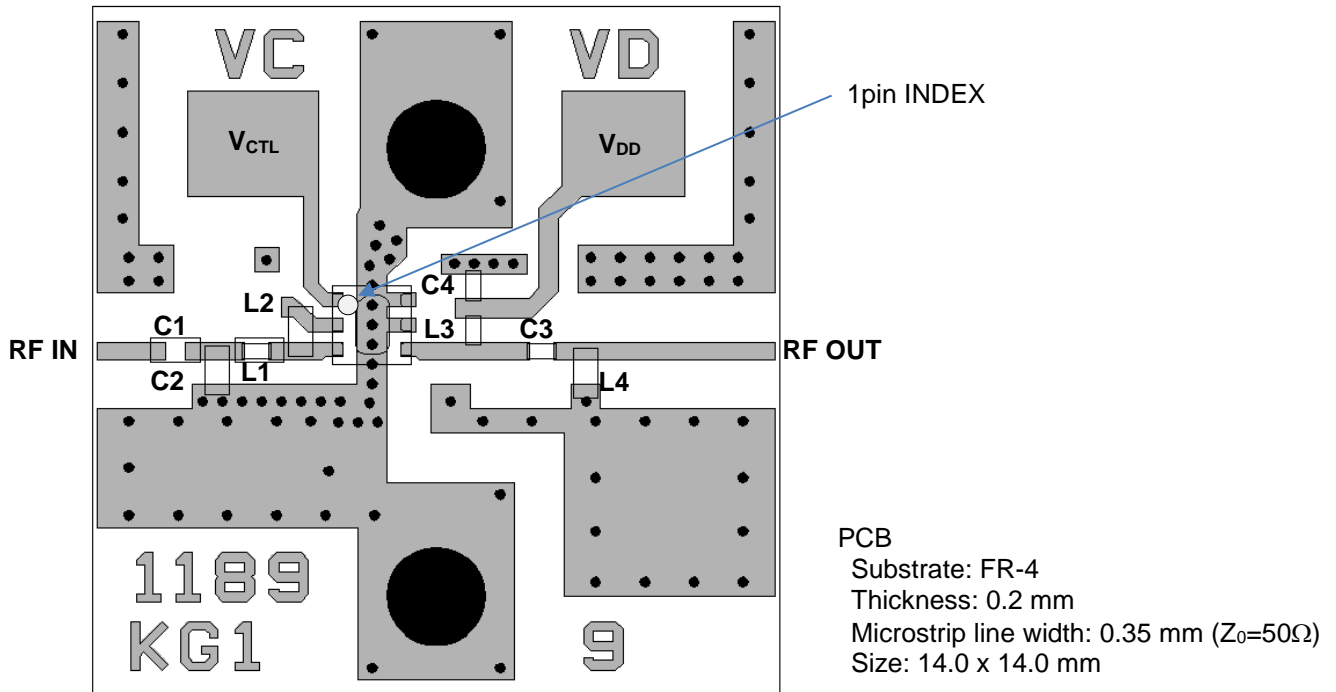

● PCB layout guideline

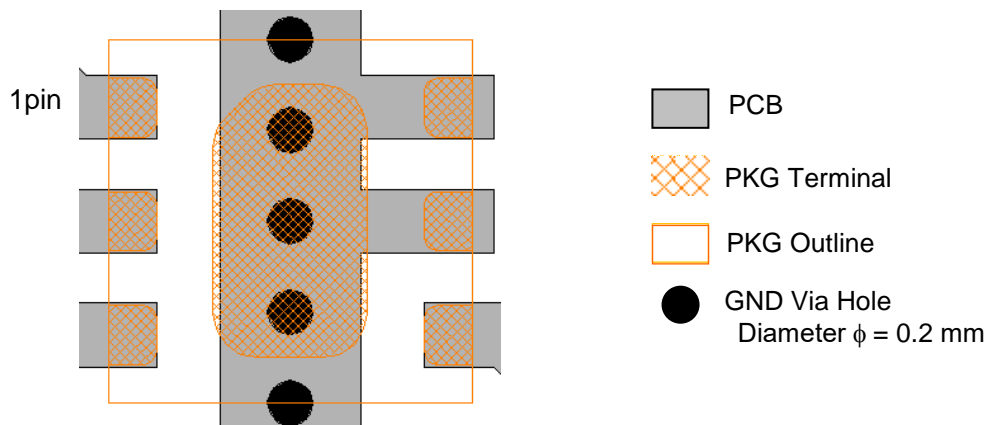

● PRECAUTIONS

- All external parts should be placed as close as possible to the LNA.
- For good RF performance, all GND terminals must be connected to PCB ground plane of substrate, and via-holes for GND should be placed near the LNA.

● NF Measurement Block Diagram

Measuring instruments

NF Analyzer : Keysight N8975A
 Noise Source : Keysight 346A

Setting the NF analyzer

Measurement mode form

Device under test : Amplifier
 System downconverter : off

Mode setup form

Sideband : LSB
 Averages : 8
 Average mode : Point
 Bandwidth : 4 MHz
 Loss comp : off
 Tcold : setting the temperature of noise source (306.15 K)

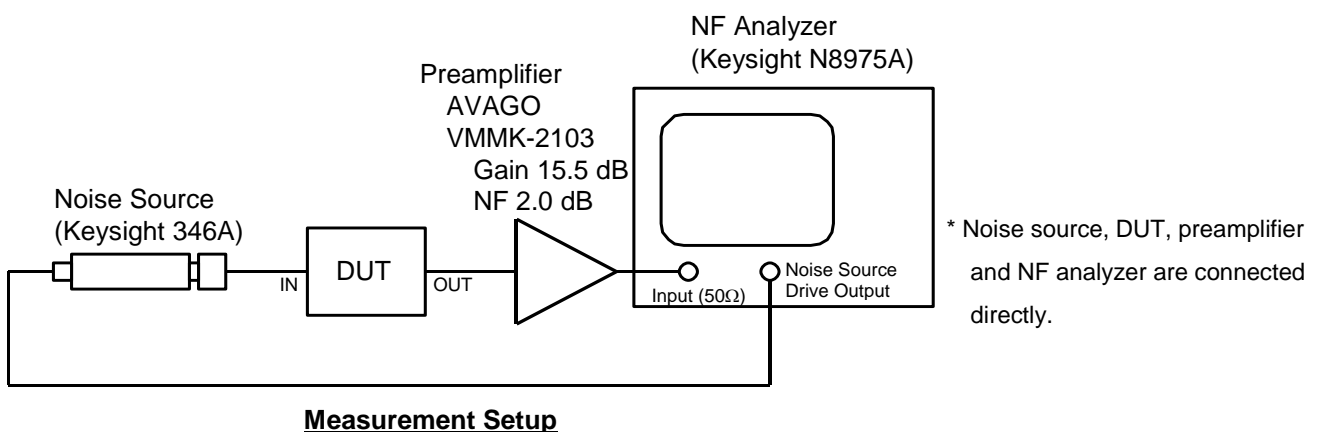
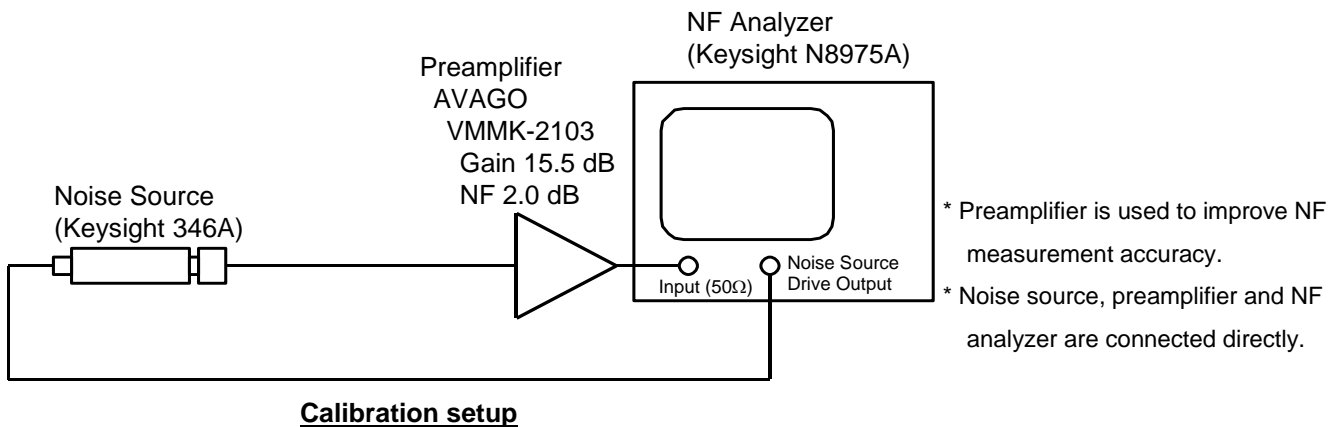

■ PACKAGE DIMENSIONS

UNIT: mm

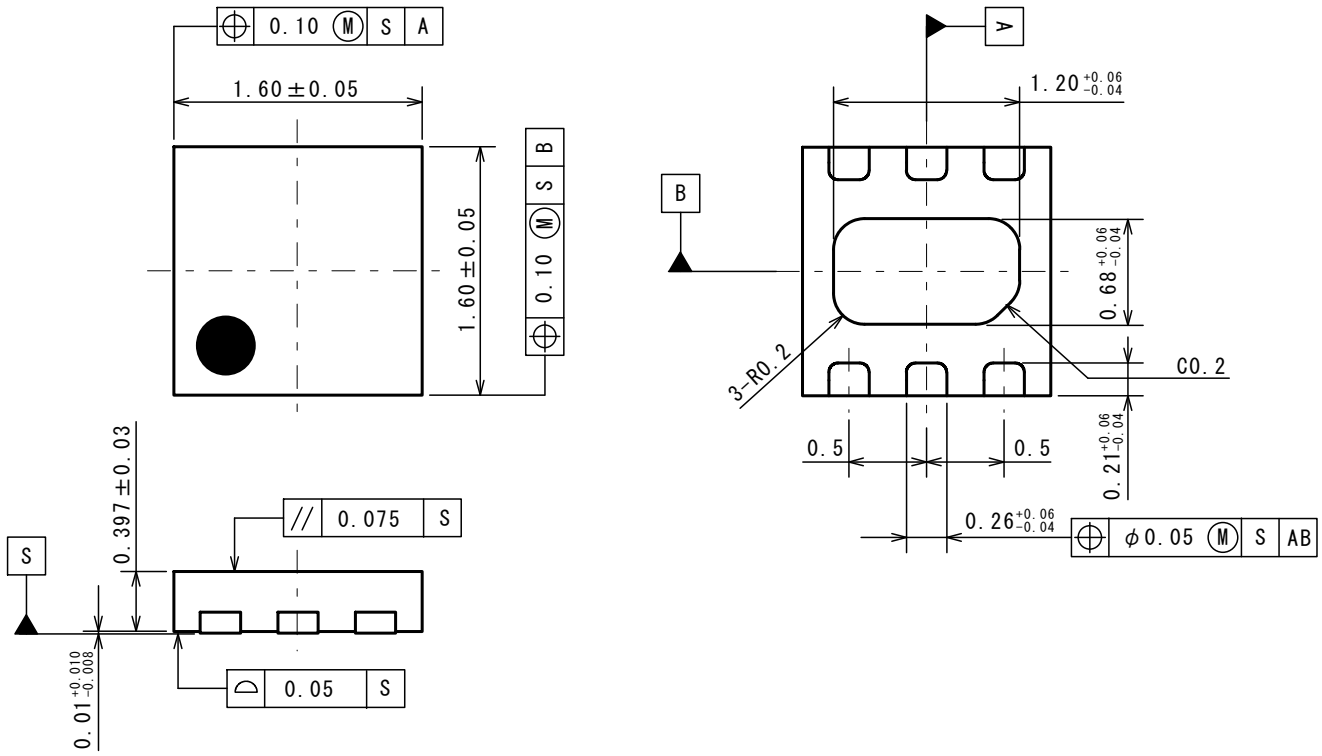

■ EXAMPLE OF SOLDER PADS DIMENSIONS

UNIT: mm

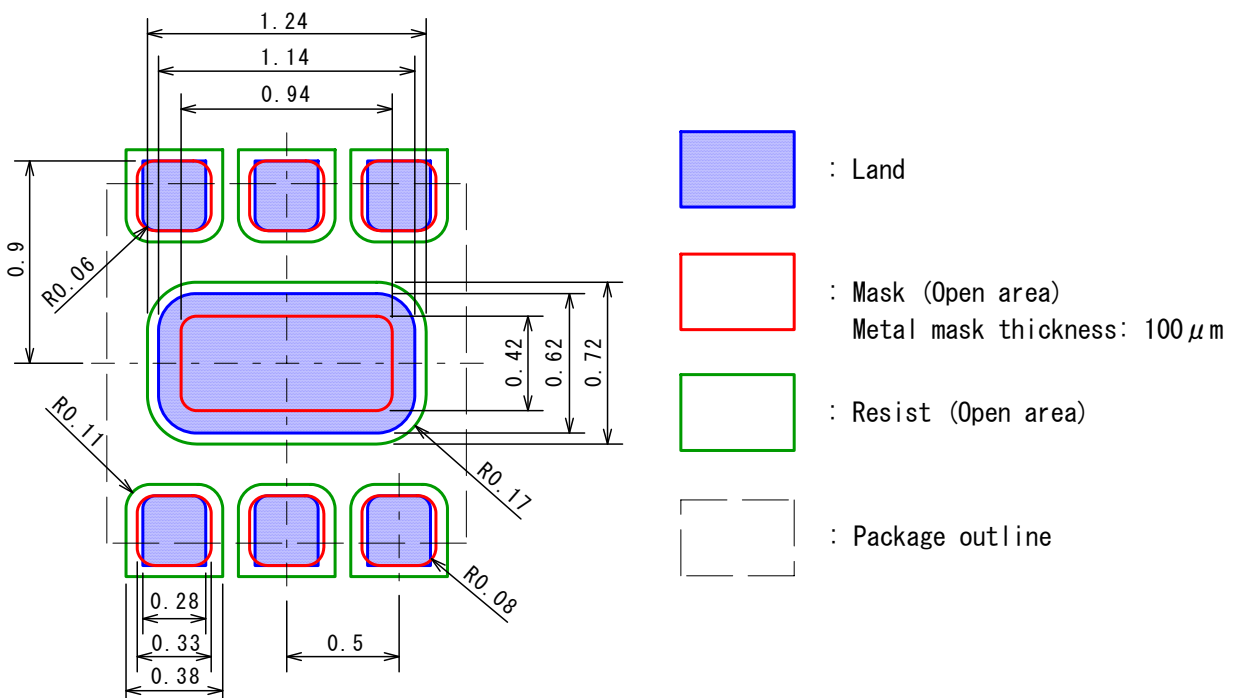

Nisshinbo Micro Devices Inc.

DFN1616-6-GD

PI-DFN1616-6-GD-E-A

■ PACKING SPEC

UNIT: mm

(1) Taping dimensions / Insert direction

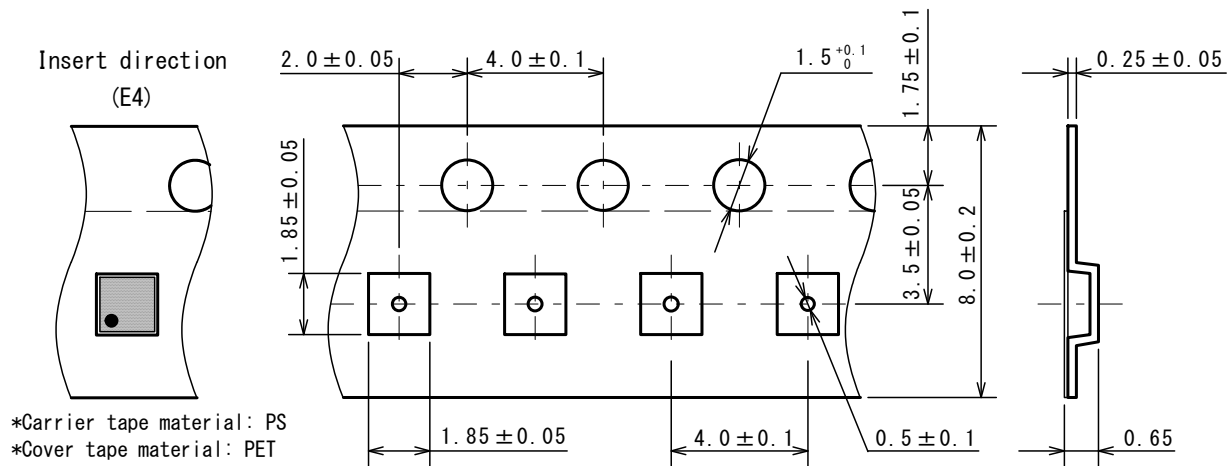
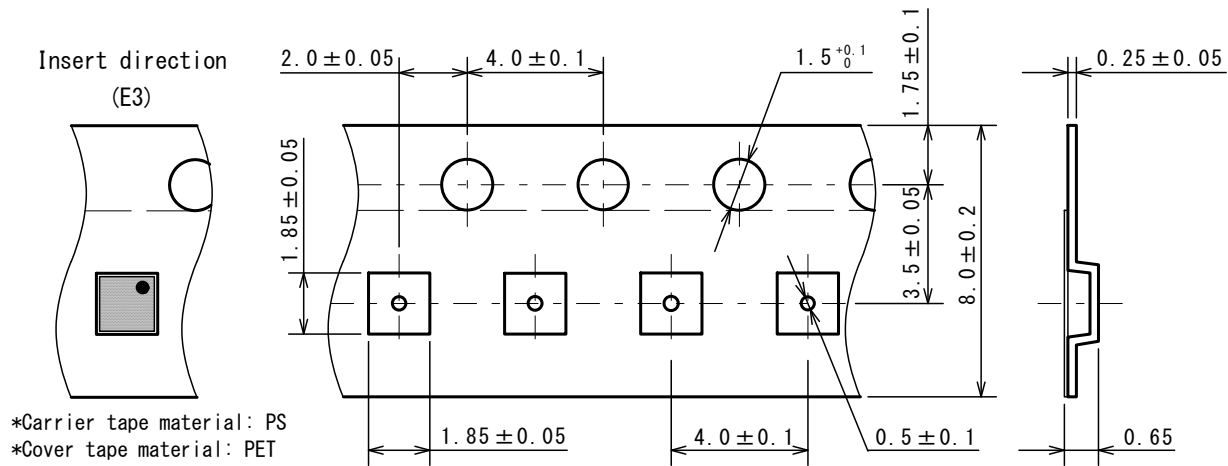

(2) Taping state

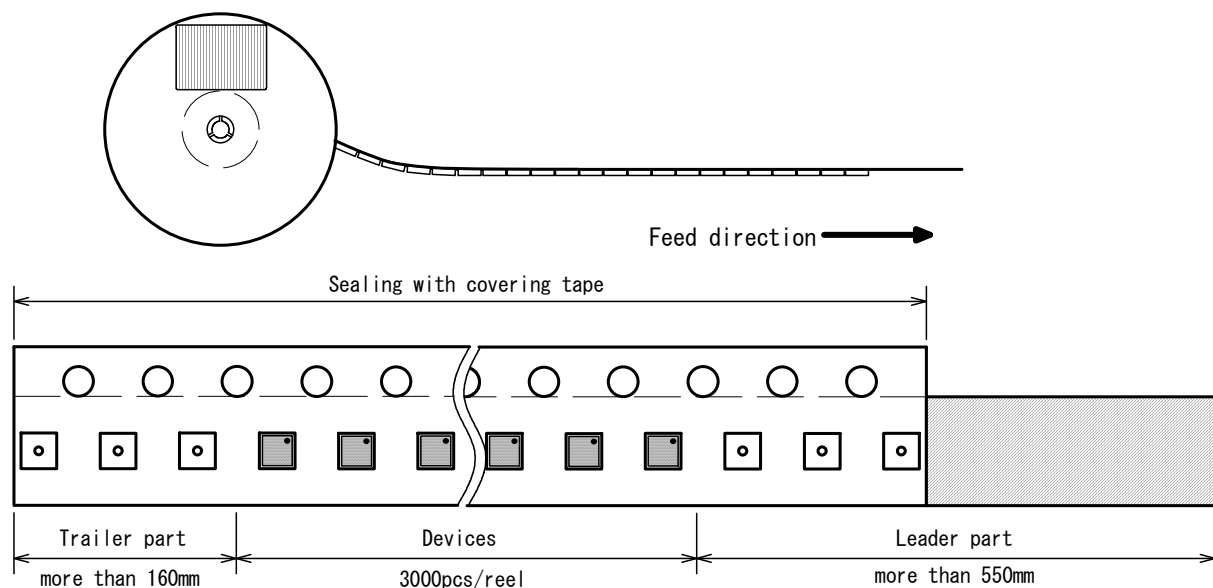

(3) Reel dimensions

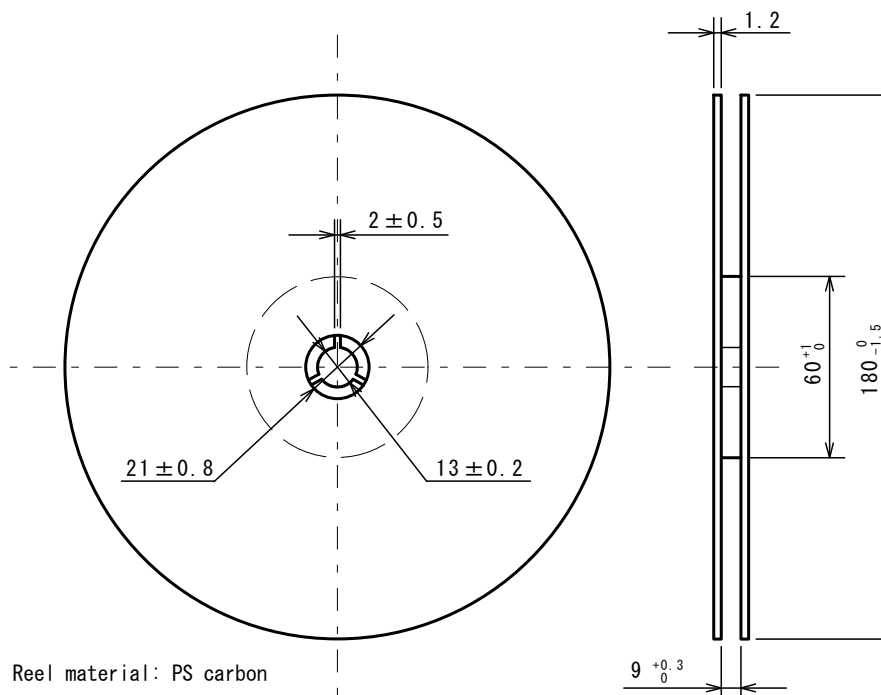

(4) Peeling strength

Peeling strength of cover tape

- Peeling angle 165 to 180° degrees to the taped surface.
- Peeling speed 300mm/min
- Peeling strength 0.1 to 1.0N

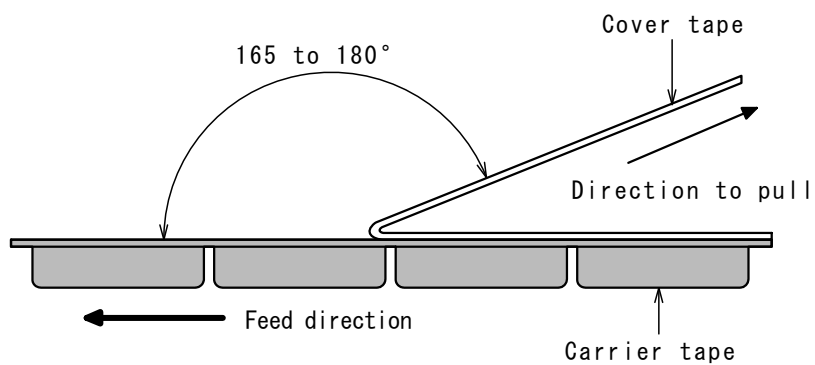

(5) Packing state

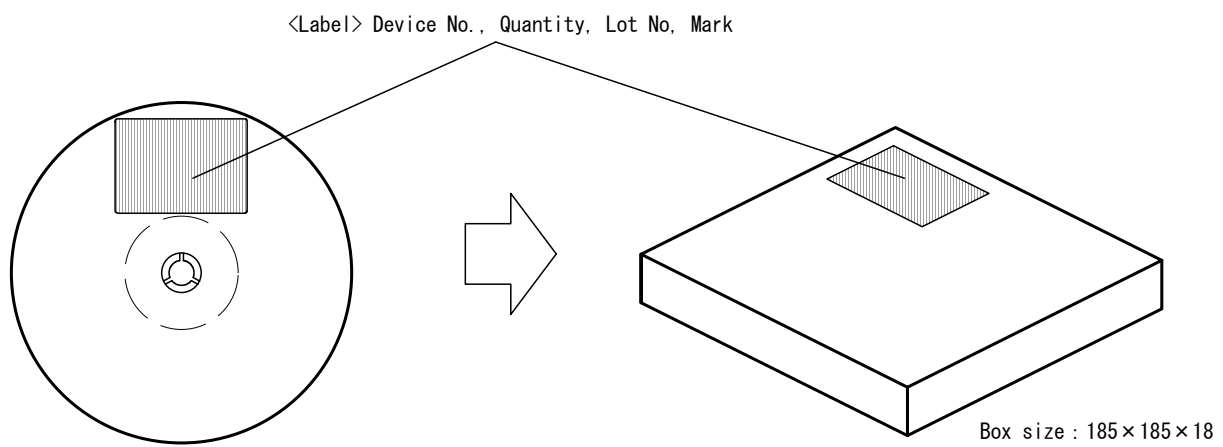

■ HEAT-RESISTANCE PROFILES

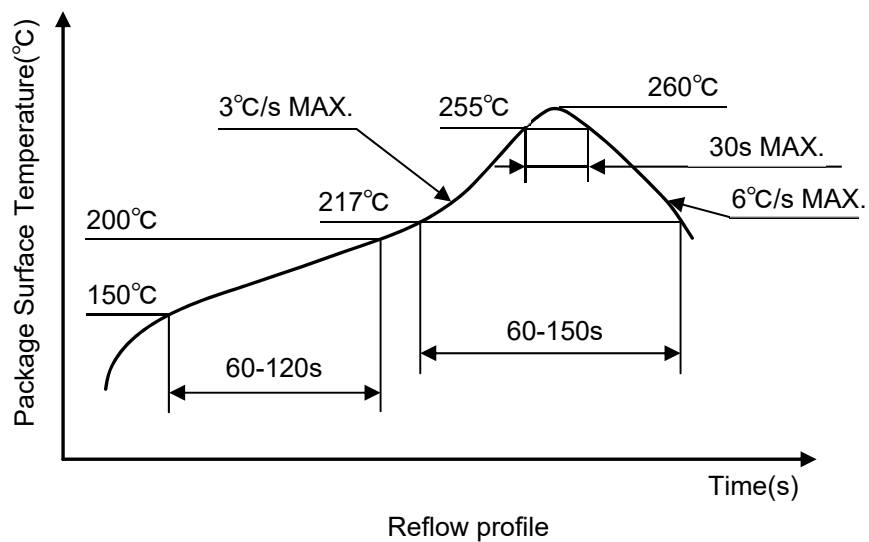

1. The products and the product specifications described in this document are subject to change or discontinuation of production without notice for reasons such as improvement. Therefore, before deciding to use the products, please refer to our sales representatives for the latest information thereon.
2. The materials in this document may not be copied or otherwise reproduced in whole or in part without the prior written consent of us.
3. This product and any technical information relating thereto are subject to complementary export controls (so-called KNOW controls) under the Foreign Exchange and Foreign Trade Law, and related politics ministerial ordinance of the law. (Note that the complementary export controls are inapplicable to any application-specific products, except rockets and pilotless aircraft, that are insusceptible to design or program changes.) Accordingly, when exporting or carrying abroad this product, follow the Foreign Exchange and Foreign Trade Control Law and its related regulations with respect to the complementary export controls.
4. The technical information described in this document shows typical characteristics and example application circuits for the products. The release of such information is not to be construed as a warranty of or a grant of license under our or any third party's intellectual property rights or any other rights.
5. The products listed in this document are intended and designed for use as general electronic components in standard applications (office equipment, telecommunication equipment, measuring instruments, consumer electronic products, amusement equipment etc.). Those customers intending to use a product in an application requiring extreme quality and reliability, for example, in a highly specific application where the failure or misoperation of the product could result in human injury or death should first contact us.
 - Aerospace Equipment
 - Equipment Used in the Deep Sea
 - Power Generator Control Equipment (nuclear, steam, hydraulic, etc.)
 - Life Maintenance Medical Equipment
 - Fire Alarms / Intruder Detectors
 - Vehicle Control Equipment (automotive, airplane, railroad, ship, etc.)
 - Various Safety Devices
 - Traffic control system
 - Combustion equipment

In case your company desires to use this product for any applications other than general electronic equipment mentioned above, make sure to contact our company in advance. Note that the important requirements mentioned in this section are not applicable to cases where operation requirements such as application conditions are confirmed by our company in writing after consultation with your company.

6. We are making our continuous effort to improve the quality and reliability of our products, but electronic device products are likely to fail with certain probability. In order to prevent any injury to persons or damages to property resulting from such failure, customers should be careful enough to incorporate safety measures in their design, such as redundancy feature, fire containment feature and fail-safe feature. We do not assume any liability or responsibility for any loss or damage arising from misuse or inappropriate use of the products.
7. The products have been designed and tested to function within controlled environmental conditions. Do not use products under conditions that deviate from methods or applications specified in this datasheet. Failure to employ the products in the proper applications can lead to deterioration, destruction or failure of the products. We shall not be responsible for any bodily injury, fires or accident, property damage or any consequential damages resulting from misuse or misapplication of the products.
8. **Quality Warranty**
 - 8-1. **Quality Warranty Period**

In the case of a product purchased through an authorized distributor or directly from us, the warranty period for this product shall be one (1) year after delivery to your company. For defective products that occurred during this period, we will take the quality warranty measures described in section 8-2. However, if there is an agreement on the warranty period in the basic transaction agreement, quality assurance agreement, delivery specifications, etc., it shall be followed.
 - 8-2. **Quality Warranty Remedies**

When it has been proved defective due to manufacturing factors as a result of defect analysis by us, we will either deliver a substitute for the defective product or refund the purchase price of the defective product.

Note that such delivery or refund is sole and exclusive remedies to your company for the defective product.
 - 8-3. **Remedies after Quality Warranty Period**

With respect to any defect of this product found after the quality warranty period, the defect will be analyzed by us. On the basis of the defect analysis results, the scope and amounts of damage shall be determined by mutual agreement of both parties. Then we will deal with upper limit in Section 8-2. This provision is not intended to limit any legal rights of your company.
9. Anti-radiation design is not implemented in the products described in this document.
10. The X-ray exposure can influence functions and characteristics of the products. Confirm the product functions and characteristics in the evaluation stage.
11. Warning for handling Gallium and Arsenic (GaAs) products (Applying to GaAs MMIC, Photo Reflector). These products use Gallium (Ga) and Arsenic (As) which are specified as poisonous chemicals by law. For the prevention of a hazard, do not burn, destroy, or process chemically to make them as gas or power. When the product is disposed of, please follow the related regulation and do not mix this with general industrial waste or household waste.
12. Front end module product is hollow seal package type, and it is with the structure susceptible to stress from the outside. Therefore, note the following in relation to the contents, after conducting an evaluation. please use.
 - 12-1. After mounting this product, to implement the potting and transfer molding, please the confirmation of resistance to temperature changes and shrinkage stress involved in the molding.
 - 12-2. When mounted on the product, collet diameter please use more than 1mmφ. In addition, the value of static load is recommended mounting less than 5N.
 - 12-3. For dynamic load at the time of mounting. please use it after confirming in consideration of the contact area /speed /load.
13. Please contact our sales representatives should you have any questions or comments concerning the products or the technical information.



Nisshinbo Micro Devices Inc.

Official website

<https://www.nisshinbo-microdevices.co.jp/en/>

Purchase information

<https://www.nisshinbo-microdevices.co.jp/en/buy/>