

---

## Si4844-B DEMO BOARD USER'S GUIDE

---

### 1. Features

- ATDD (analog tune and digital display) FM/AM/SW radio
- Worldwide FM band support from 64 to 109 MHz with 5 default sub-bands:
  - FM1 87–108 MHz (Demo Board Default)
  - FM2 86.5–109 MHz
  - FM3 87.3–108.25 MHz
  - FM4 76–90 MHz
  - FM5 64–87 MHz (Demo Board Default)
- Worldwide AM band support from 504 kHz to 1750 kHz with 5 default sub-bands:
  - AM1 520–1710 kHz (Demo Board Default)
  - AM2 522–1620 kHz (Demo Board Default)
  - AM3 504–1665 kHz
  - AM4 520–1730 kHz
  - AM5 510–1750 kHz
- Worldwide SW band support from 2.3 to 22 MHz with 16 default sub-bands:
  - SW1 5.6–6.4 MHz (DEMO Board Default)
  - SW2 5.95–6.2 MHz
  - SW3 6.8–7.6 MHz (DEMO Board Default)
  - SW4 7.1–7.6 MHz
  - SW5 9.2–10 MHz (DEMO Board Default)
  - SW6 9.2–9.9 MHz
  - SW7 11.45–12.25 MHz (DEMO Board Default)
  - SW8 11.6–12.2 MHz
  - SW9 13.4–14.2 MHz (DEMO Board Default)
  - SW10 13.57–13.87 MHz
  - SW11 15–15.9 MHz (DEMO Board Default)
  - SW12 15.1–15.8 MHz
  - SW13 17.1–18 MHz (DEMO Board Default)
  - SW14 17.48–17.9 MHz
  - SW15 21.2–22 MHz (DEMO Board Default)
  - SW16 21.45–21.85 MHz
- Supports wider FM/SW band range
- Twelve positions slide switch or one push button for selecting different bands according to the target application
- Two AAA battery operations with working voltage down to 2.0 V
- Economical potentiometer for frequency tuning replaces more expensive variable capacitor (PVC)
- Potentiometer and/or push button volume control
- FM 50  $\mu$ s or 75  $\mu$ s (default) de-emphasis
- 9-level Bass/Treble via push button control for FM
- 7-level Bass/Treble via push button control for AM/ SW
- FM/AM/SW band indicator and frequency display in LCD
- 2×4 matrix keypad
- The frequency range of each band, de-emphasis, and AM channel space can be re-configured by host MCU.

# Si4844-B-DEMO

## 2. Overview

This manual describes the operation of the Skyworks Solutions Si4844 DEMO board Rev1.4, Mar 12, 2013. The Skyworks Solutions Si4844-DEMO board is designed with the 24-pin SSOP packaged Si4844-B chip, the revolutionary single chip AM/FM/SW receiver that integrates everything from antenna input to audio output and allows use of common and economical potentiometers to do the frequency tuning. It provides a complete portable analog tune digital display AM/FM/SW radio design. The LCD displays the tuning information. The Si4844-DEMO is designed with 1-layer PCB, allowing the lowest cost without sacrificing the RF performance. The demo board works with two AAA batteries and working voltage down to 2.0 V.

## 3. Description

Figure 1 and Figure 2 shows the physical layout of the board with key components indicated.

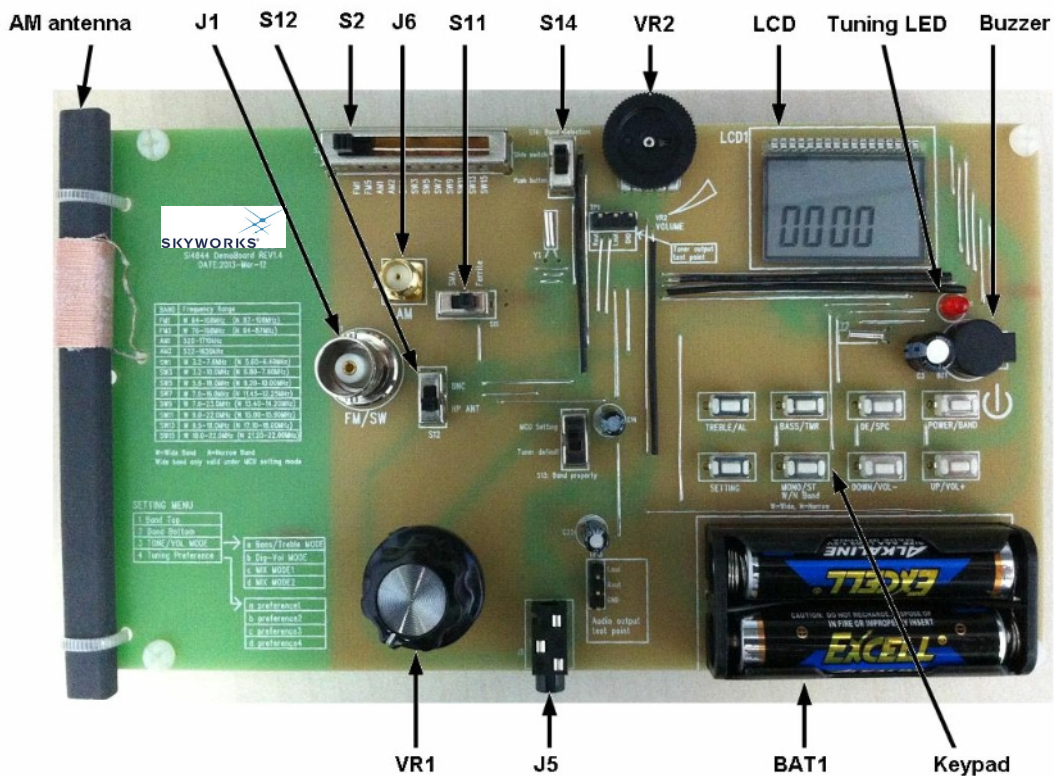

Figure 1. Si4844-DEMO Board Top Side in Time Mode

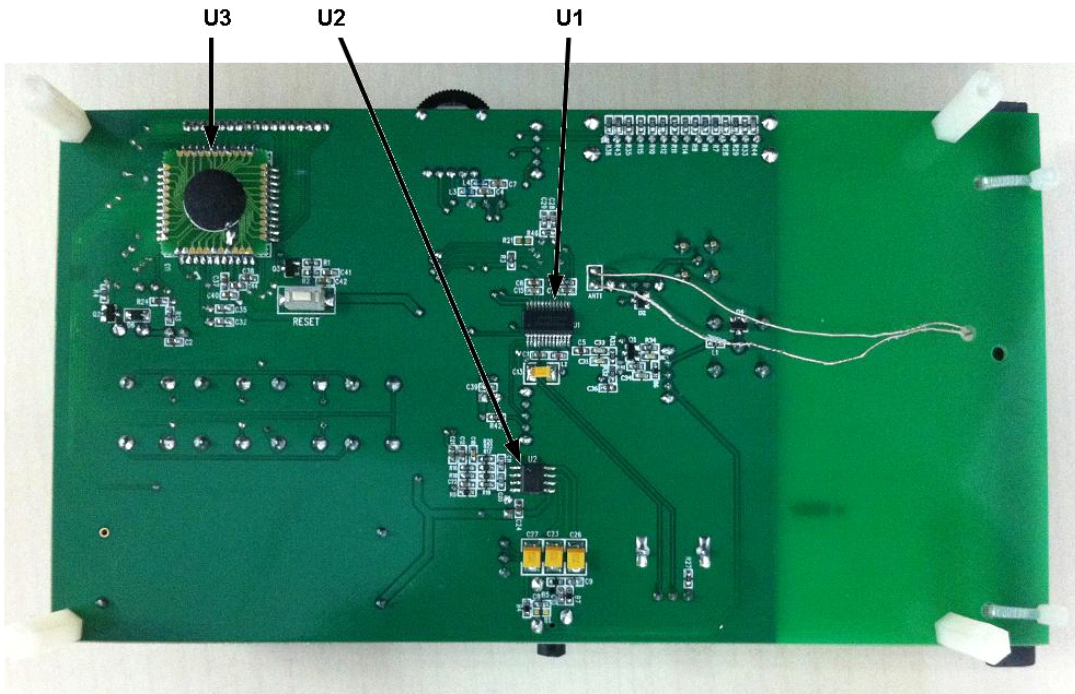

Figure 2. Si4844-DEMO Board Bottom Side

# Si4844-B-DEMO

---

## Power:

BAT1: 2 cells AAA battery holder

## Audio Connectors:

J5: Stereo audio headphone output

## Antenna Selections:

AM antenna: Ferrite stick antenna for AM

J6: SMA connector for AM conductive test

S11: AM antenna selector

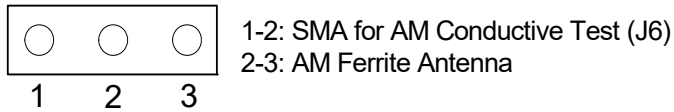

J1: BNC connector for FM/ SW conductive test or FM whip antenna

S12: FM antenna selector

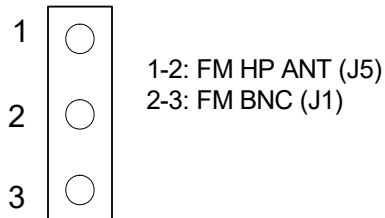

## Radio Band Selection:

The demo board provides two methods for selecting the radio band: one is to use the slide switch, S2; the other is to use the POWER/BAND push button. S14 determines which method is in use.

S14:

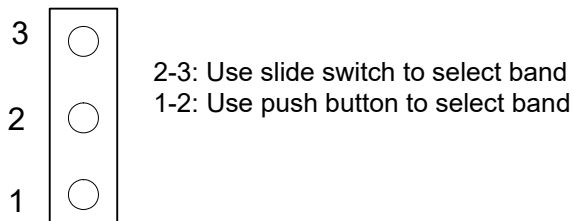

## Radio Band Property Setting

S13:

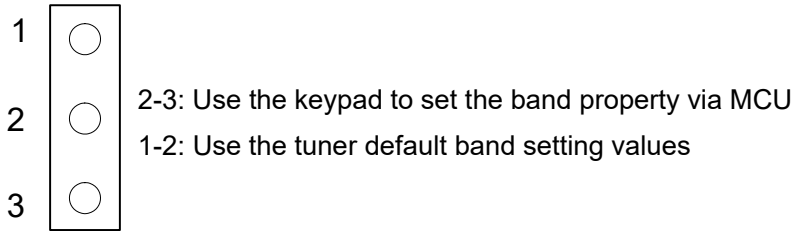

## Audio Output Test Point:

For general specification test, TP3 is the recommended audio signal test point. The audio test instrument should be connected to TP3 to get more accurate test results. J5 can also be used as an audio test point, but the test results may not be entirely accurate under some circumstances.

TP3:

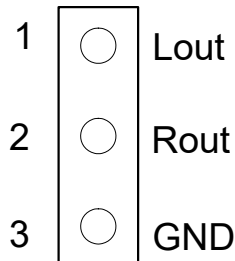

## Tuner Output Test Point:

For the tuner specification test, TP1 is the recommended tuner output test point. The audio test instrument should be connected to TP1 to get accurate test results.

TP1:

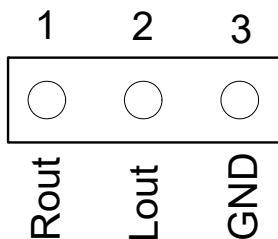

## Main Components:

U1: Skyworks Solutions Si4844-B FM/AM/SW ATDD receiver

U2: Audio amplifier

U3: MCU

LCD: The digital display for tuning information

# Si4844-B-DEMO

---

## Control Interface:

VR1: Frequency tuning wheel

VR2: Volume control wheel

S3~S10: The keypad for human interface

S2: Band switch for FM, AM, and SW

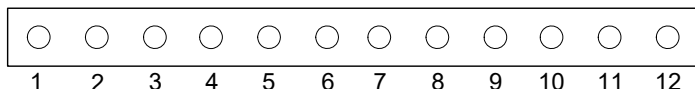

Band definition for the slide switch is as follows:

1: FM1 (W 64–108 MHz) (N 87–108 MHz), ST indication = 6 dB separation@20 dB $\mu$ V

2: FM5 (W 76–108 MHz) (N 64–87 MHz), ST indication = 6 dB separation@20 dB $\mu$ V

3: AM1 (520–1710 kHz), 10 kHz spacing

4: AM2 (522–1620 kHz), 9 kHz spacing

5: SW1 (W 3.2–7.6 MHz) (N 5.6– 6.4 MHz)

6: SW3 (W 3.2–10.0 MHz) (N 6.8–7.6 MHz)

7: SW5 (W 5.9–18.0 MHz) (N 9.2–10.0 MHz)

8: SW7 (W 7.0–16.0 MHz) (N 11.45–12.25 MHz)

9: SW9 (W 7.0–23.0 MHz) (N 13.4–14.2 MHz)

10: SW11 (W 9.0–22.0 MHz) (N 15–15.9 MHz)

11: SW13 (W 9.5–18.0 MHz) (N 17.1–18 MHz)

12: SW15 (W 10.0–22.0 MHz) (N 21.2–22 MHz)

**Note:** N = Narrow-band, W = Wideband

## Human Interface:

There are 8 keys for controlling the demo board as shown below.

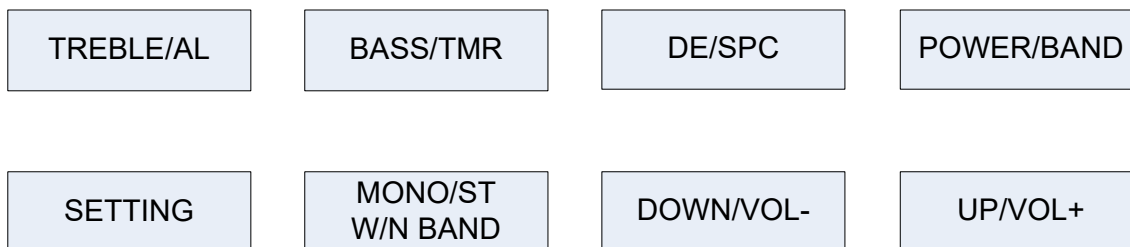

Each key can have a different function under each operating condition:

- **Time Mode:** Radio function is disabled. LCD displays time. Buttons can be used to set time, alarm, etc.
- **FM/AM/SW Radio Mode:** Tuner IC works in powerup mode. Radio function is enabled. LCD displays the radio station parameters. Buttons are used to adjust radio settings.

The functions of the buttons are summarized in Table 1

The FM/AM/SW radio parameters that can be configured are listed below in Table 2.

**Table 1. Key Function Description**

Button/Mode		Time Mode	FM/AM/SW Radio Mode
		Tuner Off	Tuner On
POWER/BAND	Hold Time < 1s	None	Change between FM, AM, and SW (there are 2 FM bands, 2 AM bands, and 8 SW bands)
	Hold Time > 1s	Enable radio	Disable radio function and enter Time mode. (Radio parameters will be saved to MCU)
DE/SPC		None	FM mode: Change De-emphasis, between 50 $\mu$ s and 75 $\mu$ s.
			AM mode: Change channel space, between 9 kHz and 10 kHz.
BASS/TMR		Enter or quit time setting menu.	Decrease Bass/Treble level by 1 step.
TREBLE/AL		Enable or disable the alarm function; enter or quit alarm setting menu.	Increase Bass/Treble level by 1 step.
UP/VOL+	Hold Time < 1s	In setting menu, change the current time/alarm parameter by one unit per each press.	In radio setting menu, change the current parameter by one unit per each press. In radio working mode, increase volume 1 step per each press.
	Hold Time > 1s	In setting menu, change the current time/alarm parameter automatically.	In radio setting menu, change the current parameter automatically. In radio working mode, increase volume level automatically until at maximum.
DOWN/VOL-	Hold Time < 1s	In setting menu, change the current time/alarm parameter by one unit per each press.	In radio setting menu, change the current parameter by one unit per each press. In radio working mode, decrease volume 1 step per each press.
	Hold Time > 1s	In setting menu, change the current time/alarm parameter automatically.	In radio setting menu, change the current parameter automatically. In radio working mode, decrease volume level automatically until at minimum.
MONO/ST W/N BAND	Hold Time < 1s	None	FM/SW mode: Change band range between wideband and narrow-band.
	Hold Time > 1s	None	FM mode: Change between forced mono audio and ST audio
SETTING	Hold Time < 1s	None	In radio setting menu, change the current item by one step per each press
	Hold Time > 1s	None	Quickly return to FM working mode.

# Si4844-B-DEMO

**Table 2. Radio Configuration Parameters**

FM Parameter	AM Parameter	SW Parameter
Bass/Treble: 0-8	Bass/Treble: 1-7	Bass/Treble: 1-7
Default: 4	Default: 3	Default: 3
Digital volume: 0-63	Digital volume: 0-63	Digital volume: 0-63
Default: 63	Default: 63	Default: 63
Band top: max 109 MHz	Band top: max 1750 kHz	Band top: max 28.5 MHz
Default: 108/108 MHz for wide band FM1/FM2	Default: 1710 kHz	Default: 7.6/10.0/18.0/16.0/23.0/22.0/18.0/22.0 MHz for wide band SW1 to SW8 respectively.
Band bottom: min 64 MHz	Band bottom: min 504 kHz	Band bottom: min 2.3 MHz
Default: 87.5 MHz for narrow-band and 64 MHz for wide-band.	Default: 522 kHz	Default: 3.2/3.2/5.9/7.0/7.0/9.0/9.5/10.0 MHz for wideband SW1 to SW8 respectively.
De-emphasis: 50 or 75 $\mu$ s	Channel space: 9 or 10 kHz	
Default: 75 $\mu$ s	Default: 9 kHz	
TONE/VOL mode: a-d		
Default: d		
Tuning preference: a-d		Tuning preference: a-d
Default: a		Default: a
<p><b>Notes:</b></p> <p>TONE/VOL mode has four modes:</p> <ol style="list-style-type: none"> <li>1. Bass/treble mode: no digital volume control, fixed volume level at 59.</li> <li>2. Digital volume mode: no bass/treble effect, volume levels from 0 to 63.</li> <li>3. Mixed mode 1: bass/treble &amp; digital volume coexist, volume levels from 0 to 63, scale to 0 ~59.</li> <li>4. Mixed mode 2: bass/treble &amp; digital volume coexist, volume levels from 0 to 63.</li> </ol> <p>The Tuning preference of FM mode has four selections:</p> <ol style="list-style-type: none"> <li>1. preference1: When tuning to adjacent channels, allow stereo separation and stereo indicator is on, the volume level decreases by 2 dB.</li> <li>2. preference2: When tuning to adjacent channels, allow stereo separation and stereo indicator is on, the volume level remains unchanged.</li> <li>3. preference3: When tuning to adjacent channels, disable stereo separation and stereo indicator is off, the volume level decreases by 2 dB.</li> <li>4. preference4: When tuning to adjacent channels, disable stereo separation and stereo indicator is off, the volume level remains unchanged.</li> </ol> <p>The Tuning preference of SW mode has two selections:</p> <ol style="list-style-type: none"> <li>1. preference1: When tuning to adjacent channels, the volume level decreases by 2 dB.</li> <li>2. preference2: When tuning to adjacent channels, the volume level remains unchanged.</li> </ol> <p>There is no tuning preference selection for AM mode.</p>		



## 4. Operation

The S4844-DEMO Board, a complete analog tune and digital display radio, provides two major modes of operation: Time mode and FM/AM/SW Radio mode.

### 4.1. Time Mode

Put two AAA batteries into the battery compartment. The board will automatically enter Time Mode and display the time. The demo board display in Time Mode is illustrated in Figure 1.

#### 4.1.1. Time Setting

The time default value is 00:00 and can be set to the correct time manually when needed.

1. In Time mode, press the BASS/TMR button to enter the setting menu. The default is to set the minute item first. Press this button again to select the hour item. The selected item flashes.
2. While the selected item is flashing, press the DOWN/VOL– and UP/VOL+ button to set the desired time.
3. When you have finished setting the time, press the BASS/TMR button to quit the setting menu. The MCU automatically quits the setting menu if there is no operation within 2 seconds.

#### 4.1.2. Alarm Setting

1. In Time mode, press the TREBLE/AL button to enable or disable the alarm function, and enter the setting menu automatically when the alarm is enabled. Once you have entered the setting menu, the default is to set the minute item first. Press this button again to select the hour item. The selected item flashes.
2. While the selected item is flashing, press the DOWN/VOL– and UP/VOL+ button to set the desired time.
3. When you have finished the alarm setting, press the TREBLE/AL button to quit the setting menu. The MCU automatically quits the setting menu if there is no operation within 2 seconds.
4. If the alarm is enabled and the alarm setting time is matched, the radio will be automatically turned on after the buzzer sounds for 5 seconds.
5. The radio will be turned off and demo board will go into sleep mode automatically if there is no operation on the buttons within 15 minutes; if there is any operation on the buttons, the auto-sleep function will be disabled. The radio keeps working throughout this time.

# Si4844-B-DEMO

## 4.2. FM/AM/SW Radio Mode

In Time mode, after a long press (hold time > 1s) of the POWER/BAND button or when the alarm time is reached, the device will enter FM/AM/SW Mode. The LCD displays the following information: band indicator, band frequency indicator, and sleep indicator in case the radio is automatically turned on by the alarm.

The demo board display in FM/AM/SW Mode is illustrated in Figure 3.

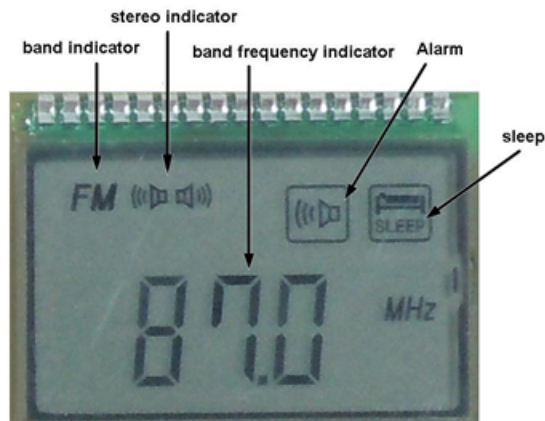

**Figure 3. LCD Display in FM Radio Mode**

The demo board provides two methods for selecting the radio band. One is to use the slide switch S2. The other is to use the POWER/BAND push button. S14 determines which method is in use.

The demo board also provides two methods for setting the band property. One is to use the tuner default values. The other method is to use the keypad to reconfigure the band property value via the MCU. S13 determines which method is in use. If you use the tuner default values, the band property is fixed and cannot be reconfigured. Refer to Section "4.2.1. MCU Setting Band Property" for the operation details for setting the band property using the keypad.

To operate the demo board, follow these procedures:

1. According to the desired radio band selection method, set S14 to use slide switch or push button.
2. According to the desired radio band property, set S13 to use tuner default values or reconfigure the band property via MCU.
3. Hold the POWER/BAND button (hold time > 1s) or when the alarm time is reached, the device will enter FM/AM/SW Mode.
4. Use slide switch S2 or press the POWER/BAND push button to select the desired band.
5. Refer to Section "4.2.1. MCU Setting Band Property" or section "4.2.2. MCU Setting Radio Working Mode" to reconfigure the band property or radio working mode if necessary.
6. Rotate the tuning wheel and find the desired radio station with the help of the LCD display and/or tuning indicator D1.
7. Rotate the volume control wheel VR2 and/or press the DOWN/VOL- or UP/VOL+ button to get a comfortable volume. Press the BASS/TMR or TREBLE/AL button to get the desired bass/treble level.

**Note:** For FM listening, the earphone cable must be connected to the board when S12 is set to HP ANT or an external antenna must be connected to the BNC connector when S12 is set to BNC.  
For AM listening, the ferrite antenna must be connected to the board and the S11 is set to Ferrite before turning on the radio or switching the band to AM.

## 4.2.1. MCU Setting Band Property

The demo board provides the function that the band property can be set by MCU. The band property includes:

- Band top
- Band bottom
- De-emphasis (only for FM)
- Channel space (only for AM)

The setting menu is illustrated in Figure 4.

To set the band properties, follow these steps:

1. Press the SETTING button to enter the setting menu and select the item to be set. The selected item flashes for 1 second, then automatically switches to its current value.
2. While the value is flashing, press the DOWN/VOL- or UP/VOL+ button to set the desired value within 3 seconds.
3. Repeat step 1 and 2 to finish setting the band properties.
4. When the band properties are set, the MCU automatically quits the setting menu if there is no operation within 3 seconds.
5. In FM working mode, press the DE/SPC button to set the De-emphasis 50  $\mu$ s or 75  $\mu$ s.
6. In AM working mode, press the DE/SPC button to set the Channel Space 9 kHz or 10 kHz.

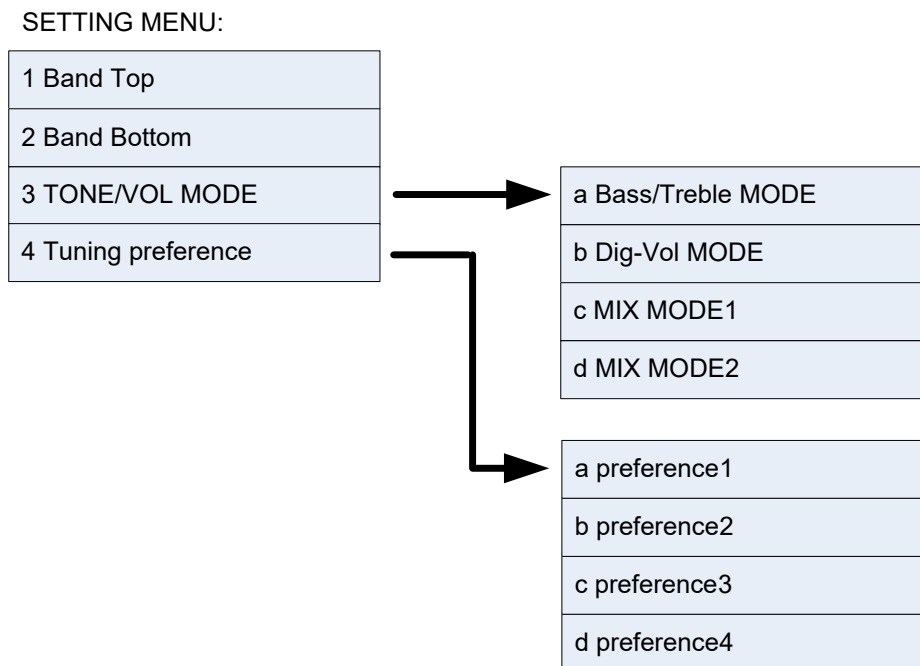

**Figure 4. Setting Menu**

# Si4844-B-DEMO

---

## 4.2.2. MCU Setting Radio Working Mode

The host MCU can set the radio working mode.

The working modes include:

- Tone/volume mode (only for FM), item 3 in setting menu
- Tuning preference (only for FM and SW), item 4 in setting menu
- Forced mono audio/ST audio (only for FM)

Follow these procedures to set radio working mode:

1. Press the SETTING button to enter item 3. The LCD displays the item number st3 for 1 second, then automatically switches to its mode indication.
2. Press the DOWN/VOL– or UP/VOL+ button to select the desired mode within 3 seconds.
3. Repeat steps 1 and 2 to set the tuning preference by setting the item 4.
4. When the radio working mode is set, the MCU automatically quits the setting menu if there is no operation within 3 seconds.
5. Press the MONO/ST button to select forced mono audio or ST audio in FM mode when necessary.

## 5. Bill of Materials

- ATDD AM/FM/SW receiver IC Si4844-B with external 32.768 kHz crystal oscillator support
- LM4910MA audio amplifier IC
- TM8723 MCU
- See Table 3 for details

**Table 3. Si4844-DEMO Board Bill of Materials REV 1.4**

Item	Qty	Reference	Description	Value
1	12	C1-2 C6 C19 C24 C37-42 C44	CAP,SM,0603,X7R	0.1 $\mu$
2	2	C5 C36	CAP,SM,0603,X7R	0.47 $\mu$
3	2	C8 C10	CAP,SM,0603,COG	100p
4	1	C33	CAP,SM,0603,COG	10p
5	4	C28-29 C32 C35	CAP,SM,0603,COG	22p
6	2	C11 C20	CAP,SM,0603,COG	150p
7	2	C30-31	CAP,SM,0603,X7R	33n
8	1	C34	CAP,SM,0603,COG	33p
9	1	C15	CAP,SM,0603,X7R	4.7 $\mu$
10	4	C4 C7 C12 C21	CAP,SM,0603,X7R	10.0 $\mu$
11	1	C13	CAP,SM,1210,X7R	47 $\mu$
12	2	C18 C22	CAP,SM,0603,COG	330p
13	3	C23 C26 C27	CAP,SM,1210,X7R	220 $\mu$
14	2	C14 C25	Electrolytic capacitor	100 $\mu$ /4 V
15	1	C3	Electrolytic capacitor	220 $\mu$ /4 V
16	1	R34	RES,SM,0603	100k
17	1	R27	RES,SM,0603	100R
18	2	R5 R6	RES,SM,0603	2k
19	1	R32	RES,SM,0603	10R
20	2	R3 R42	RES,SM,0603	10k
21	1	R41	RES,SM,0603	120k
22	2	R17 R22	RES,SM,0603	12k
23	2	R1-2	RES,SM,0603	1M
24	2	R4 R31	RES,SM,0603	1k
25	1	R24	RES,SM,0603	200R
26	1	R13	RES,SM,0603	22R
27	2	R16 R18	RES,SM,0603	2.2k
28	1	R46	RES,SM,0603	4.7M
29	2	R19 R20	RES,SM,0603	6.8k
30	1	R21	RES,SM,0603	NP

# Si4844-B-DEMO

**Table 3. Si4844-DEMO Board Bill of Materials REV 1.4 (Continued)**

Item	Qty	Reference	Description	Value
31	1	R7	RES,SM,0603,Tolerance ±1%	10k 1%
32	1	R29	RES,SM,0603,Tolerance ±1%	160k 1%
33	9	R9-12 R14-15 R28 R33 R35	RES,SM,0603,Tolerance ±1%	20k 1%
34	1	R43	RES,SM,0603,Tolerance ±1%	30k 1%
35	1	R36	RES,SM,0603,Tolerance ±1%	33k 1%
36	1	R8	RES,SM,0603,Tolerance ±1%	40k 1%
37	1	R44	RES,SM,0603,Tolerance ±1%	47k 1%
38	1	U1	SI4844-B SOIC16	Si4844-B
39	1	U2	LM4910MA,SO8	LM4910MA
40	1	U3	TM8795 44 PIN	TM8795 44 PIN
41	1	Q2	TRANSISTOR NPN SOT23	2N3904
42	1	Q1	TRANSISTOR NPN SOT23	2SC9018
43	1	Q3	TRANSISTOR NPN SOT23	2N3906
44	2	D2 D4	DIODE,SM,ESD,SOT23	BAV99
45	4	B4 B5 B6 B7	FERRITE BEAD,SM,0603	2.5 k/100M
46	1	B1	FERRITE BEAD,SM,0603	NP
47	1	BZ1	BUZZER	BUZZER
48	2	Y1-2	CRYSTAL	32.768KHz
49	1	D1	LED	LED
50	1	D6	1N4148	1N4148
51	1	J5	Stereo earphone jack with switch	3.5mm
52	1	L1	RES,SM,0603	0R
53	1	L2	IND,SM,0603	270 nH
54	2	L3 L4	IND,SM,0603	120 nH
55	2	TP1 TP3	CONN,TH,1x3,HDR	CONN,TH,1x3,HDR
56	1	LCD1	LCD	LCD
57	1	J1	BNC VERTICAL	BNC for FM testing
58	1	J6	SMA VERTICAL	SMA for AM testing
59	1	ANT1	AW ferrite stick antenna	220 µH
60	1	BAT1	BATTERY BOX ,AAA*2 SIZE	
61	4	S11 S12 S13 S14	One pole two throw switch	
62	1	S2	Single pole twelve throw switch	
63	9	S1 S3-10	Push button	
64	1	VR1	100k,±10%,Variable resistor(POT)	100k
65	1	VR2	10k,±20%,Variable resistor(POT)	10k

## 6. Schematics

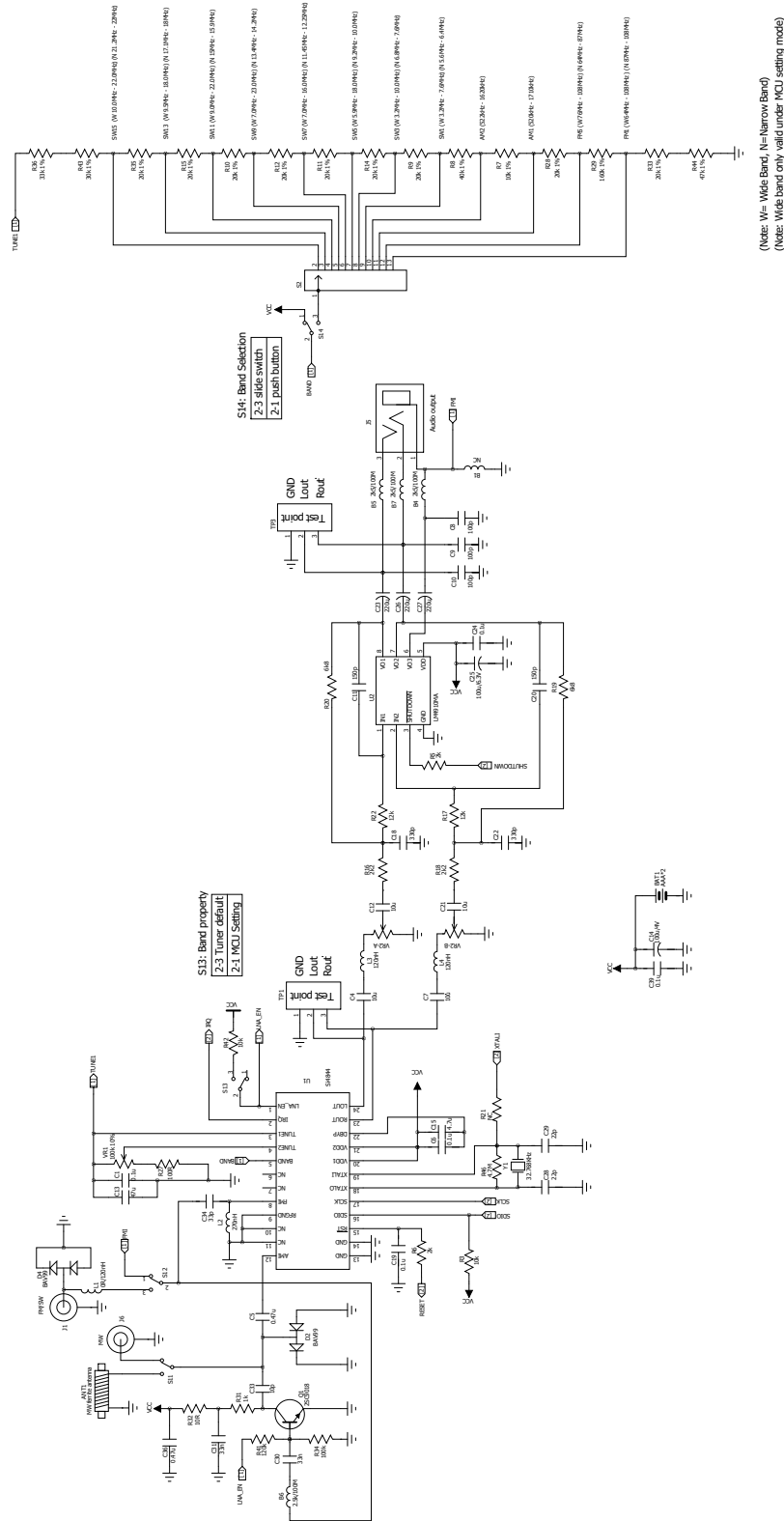

Figure 5. Si4844-DEMO Board Schematic REV1.4

# Si4844-B-DEMO

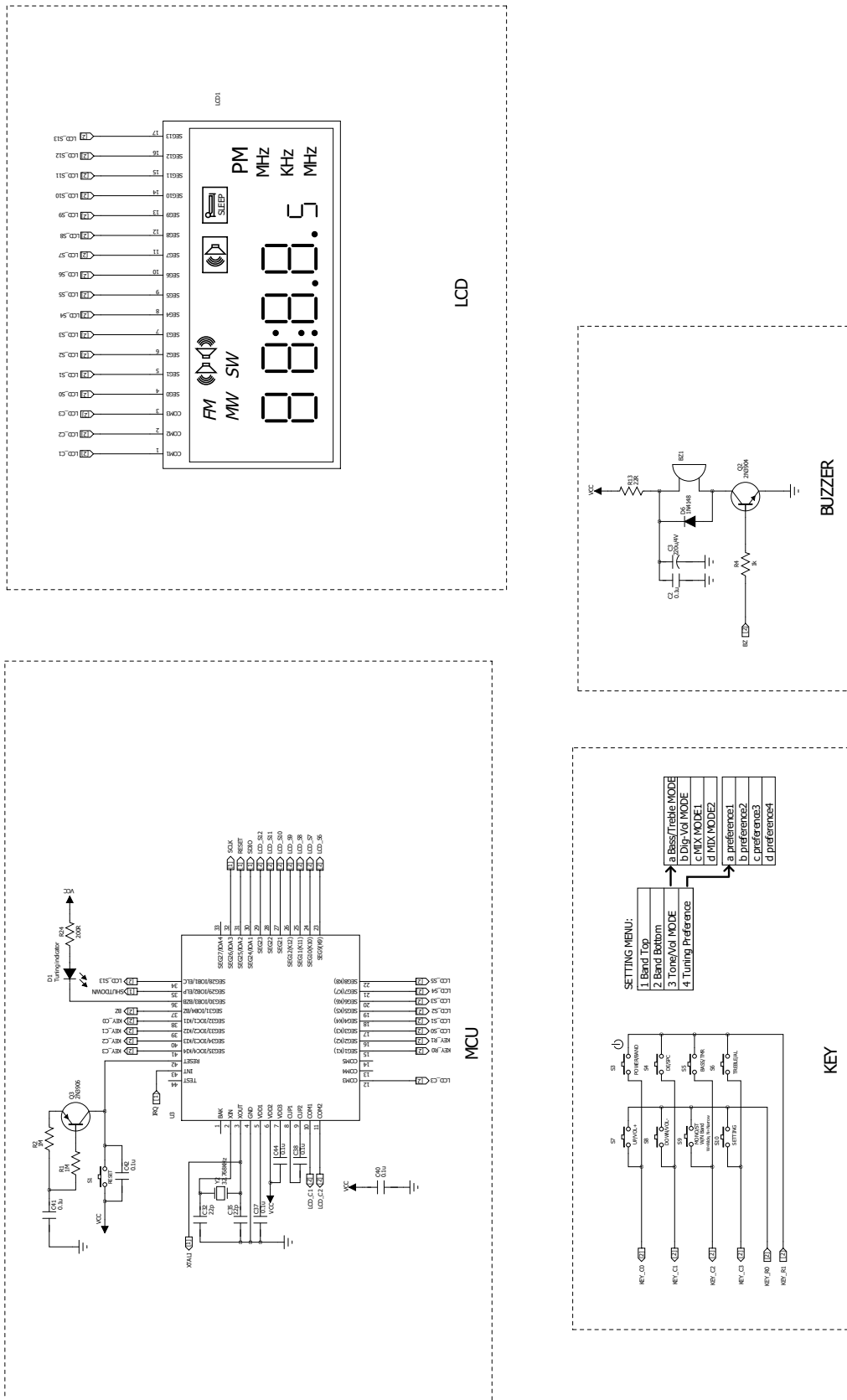

Figure 6. Si4844-DEMO Board Schematic REV1.4



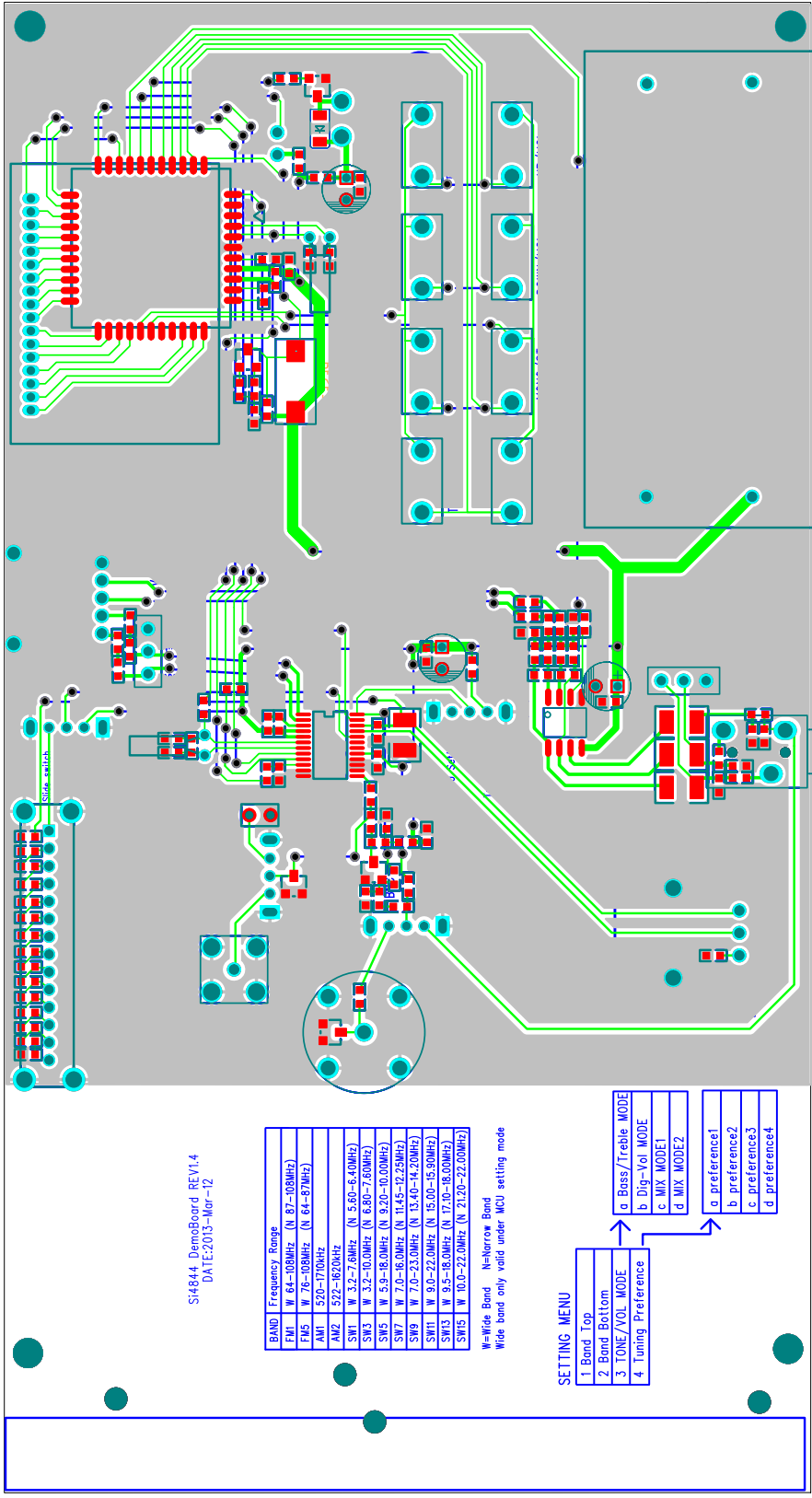

Figure 7. Si4844-DEMO Board Gerber REV1.4



# SKYWORKS®

**Connecting Everyone  
and Everything,  
All the Time**



**Portfolio**

[www.skyworksinc.com](http://www.skyworksinc.com)

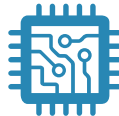

**Quality**

[www.skyworksinc.com/quality](http://www.skyworksinc.com/quality)



**Support & Resources**

[www.skyworksinc.com/support](http://www.skyworksinc.com/support)

**Copyright © 2021 Skyworks Solutions, Inc. All Rights Reserved.**

Information in this document is provided in connection with Skyworks Solutions, Inc. ("Skyworks") products or services. These materials, including the information contained herein, are provided by Skyworks as a service to its customers and may be used for informational purposes only by the customer. Skyworks assumes no responsibility for errors or omissions in these materials or the information contained herein. Skyworks may change its documentation, products, services, specifications or product descriptions at any time, without notice. Skyworks makes no commitment to update the materials or information and shall have no responsibility whatsoever for conflicts, incompatibilities, or other difficulties arising from any future changes.

No license, whether express, implied, by estoppel or otherwise, is granted to any intellectual property rights by this document. Skyworks assumes no liability for any materials, products or information provided hereunder, including the sale, distribution, reproduction or use of Skyworks products, information or materials, except as may be provided in Skyworks' Terms and Conditions of Sale.

THE MATERIALS, PRODUCTS AND INFORMATION ARE PROVIDED "AS IS" WITHOUT WARRANTY OF ANY KIND, WHETHER EXPRESS, IMPLIED, STATUTORY, OR OTHERWISE, INCLUDING FITNESS FOR A PARTICULAR PURPOSE OR USE, MERCHANTABILITY, PERFORMANCE, QUALITY OR NON-INFRINGEMENT OF ANY INTELLECTUAL PROPERTY RIGHT; ALL SUCH WARRANTIES ARE HEREBY EXPRESSLY DISCLAIMED. SKYWORKS DOES NOT WARRANT THE ACCURACY OR COMPLETENESS OF THE INFORMATION, TEXT, GRAPHICS OR OTHER ITEMS CONTAINED WITHIN THESE MATERIALS. SKYWORKS SHALL NOT BE LIABLE FOR ANY DAMAGES, INCLUDING BUT NOT LIMITED TO ANY SPECIAL, INDIRECT, INCIDENTAL, STATUTORY, OR CONSEQUENTIAL DAMAGES, INCLUDING WITHOUT LIMITATION, LOST REVENUES OR LOST PROFITS THAT MAY RESULT FROM THE USE OF THE MATERIALS OR INFORMATION, WHETHER OR NOT THE RECIPIENT OF MATERIALS HAS BEEN ADVISED OF THE POSSIBILITY OF SUCH DAMAGE.

Skyworks products are not intended for use in medical, lifesaving or life-sustaining applications, or other equipment in which the failure of the Skyworks products could lead to personal injury, death, physical or environmental damage. Skyworks customers using or selling Skyworks products for use in such applications do so at their own risk and agree to fully indemnify Skyworks for any damages resulting from such improper use or sale.

Customers are responsible for their products and applications using Skyworks products, which may deviate from published specifications as a result of design defects, errors, or operation of products outside of published parameters or design specifications. Customers should include design and operating safeguards to minimize these and other risks. Skyworks assumes no liability for applications assistance, customer product design, or damage to any equipment resulting from the use of Skyworks products outside of Skyworks' published specifications or parameters.

Skyworks, the Skyworks symbol, Sky5®, SkyOne®, SkyBlue™, Skyworks Green™, Clockbuilder®, DSPLL®, ISOModem®, ProSLIC®, and SiPHY® are trademarks or registered trademarks of Skyworks Solutions, Inc. or its subsidiaries in the United States and other countries. Third-party brands and names are for identification purposes only and are the property of their respective owners. Additional information, including relevant terms and conditions, posted at [www.skyworksinc.com](http://www.skyworksinc.com), are incorporated by reference.

Skyworks Solutions, Inc. | Nasdaq: SWKS | [sales@skyworksinc.com](mailto:sales@skyworksinc.com) | [www.skyworksinc.com](http://www.skyworksinc.com)

USA: 781-376-3000 | Asia: 886-2-2735 0399 | Europe: 33 (0)1 43548540 | [in](#) [f](#) [t](#) [v](#)