

NOTES

1. APPLICABLE FEMALE HOUSING : 35564-2015, 35564-2016, 35563-1615
A(GRAY) B(BLACK) C(GRAY)
2. PLATING : SN 1-3 OVER NI 1-4 (MICRO METER)
3. PIN POSITION OF SOLDER AREA SHOULD BE CHECKED IN MATING PCB CHARACTERISTIC PRIOR TO DIMENSION.

5	FITTING NAIL (R) FOR R/A SMT	BRASS (POST-TIN)	1
4	FITTING NAIL (L) FOR R/A SMT	BRASS (POST-TIN)	1
3	040 WTB MALE TML (S) FOR R/A SMT	BRASS (POST-TIN)	28
2	040 WTB MALE TML (L) FOR R/A SMT	BRASS (POST-TIN)	28
1	040 WTB R/A SMT HEADER HSG 5P	SPS-GF30	1
NO	DESCRIPTION	MATERIAL/PLATING	Q'TY

<TABLE 1>

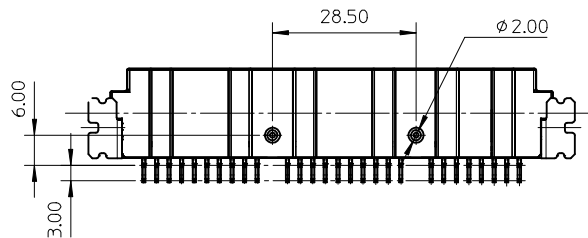

MATERIAL NO	ORDER NO	COLOR
1041835621	104183-5621	BLACK

PCB LAYOUT (MOUNTING SIDE)

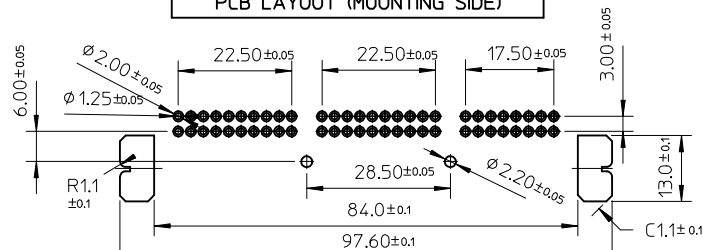

ENTER DESCRIPTION
EC NO: KTR2014-0038
DRWN: JWK1M02 2014/11/12
CHKD:
APPR: JYCH01 2014/12/31

QUALITY SYMBOLS
F_A=0
F_C=0
F_P=0

GENERAL TOLERANCES (UNLESS SPECIFIED)

	mm	INCH
4 PLACES	±0	±0
3 PLACES	±0.25	±0
2 PLACES	±0.3	±0
1 PLACE	±0	±0
0 PLACE	±0	±0

ANGULAR ± 1 °
DRAFT WHERE APPLICABLE
MUST REMAIN WITHIN DIMENSIONS

DIMENSION STYLE
MM ONLY

DRAWN BY	DATE	TITLE
JWK1M02	2014/11/12	040 WTB R/A SMT HEADER ASSY 56P
CHECKED BY	DATE	
BCYOON	2014/11/12	
APPROVED BY	DATE	
JYCH01	2014/12/31	

MATERIAL NO. SEE TABLE
SIZE A3
THIS DRAWING CONTAINS INFORMATION THAT IS PROPRIETARY TO MOLEX INCORPORATED AND SHOULD NOT BE USED WITHOUT WRITTEN PERMISSION

SCALE 1:1
DESIGN UNITS METRIC
THIRD ANGLE PROJECTION

040 WTB R/A SMT HEADER ASSY 56P

molex

MATERIAL NO. SD-104083-001_ DOCUMENT NO. SHEET NO. 1 OF 1

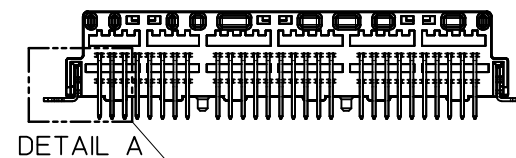
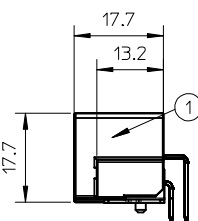
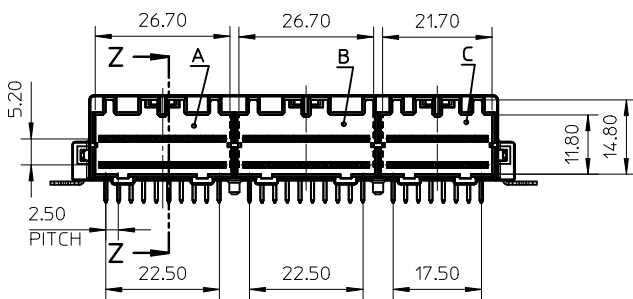
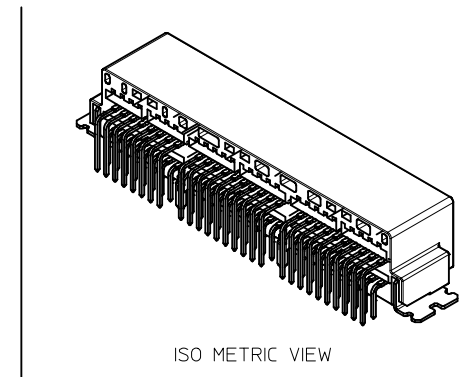
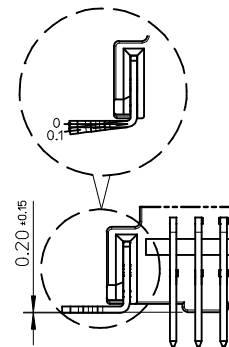
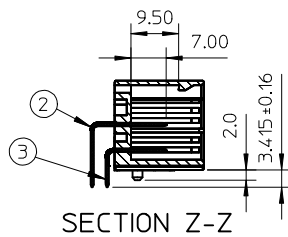
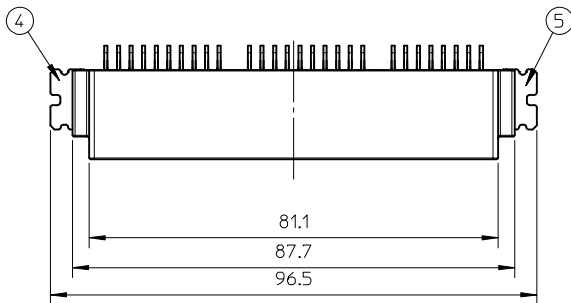

NOTES

1. APPLICABLE FEMALE HOUSING : 35564-2015, 35564-2016, 35563-1615
A(GRAY) B(BLACK) C(GRAY)
2. PLATING : SN 1-3 OVER NI 1-4 (MICRO METER)
3. PIN POSITION OF SOLDER AREA SHOULD BE CHECKED IN MATING PCB CHARACTERISTIC PRIOR TO DIMENSION.

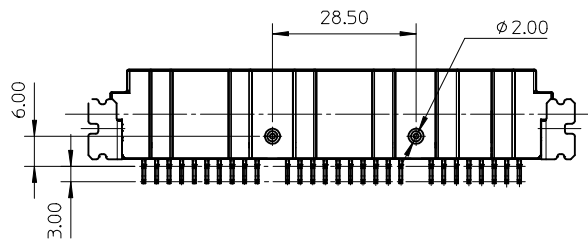

NO	DESCRIPTION	MATERIAL/PLATING	Q'TY
5	FITTING NAIL (R) FOR R/A SMT	BRASS (POST-TIN)	1
4	FITTING NAIL (L) FOR R/A SMT	BRASS (POST-TIN)	1
3	040 WTB MALE TML (S) FOR R/A SMT	BRASS (POST-TIN)	28
2	040 WTB MALE TML (L) FOR R/A SMT	BRASS (POST-TIN)	28
1	040 WTB R/A SMT HEADER HSG 5P	SPS-GF30	1

<TABLE 1>

MATERIAL NO	ORDER NO	COLOR
1041835621	104183-5621	BLACK

PCB LAYOUT (MOUNTING SIDE)

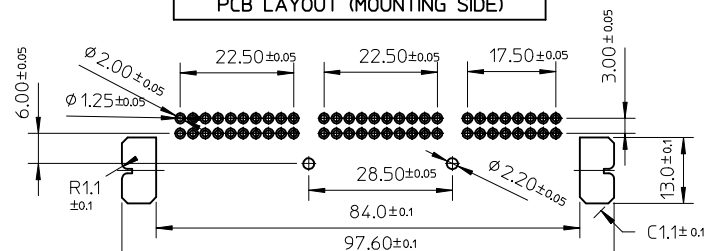

ENTER DESCRIPTION
EC NO: KTR2014-0038
DRWN: JWK IM02 2014/11/12
CHKD:
APPR: JYCH01 2014/12/31

QUALITY SYMBOLS
F_A=0
F_C=0
F_P=0

GENERAL TOLERANCES (UNLESS SPECIFIED)

	mm	INCH
4 PLACES	±0	±0
3 PLACES	±0.25	±0
2 PLACES	±0.3	±0
1 PLACE	±0	±0
0 PLACE	±0	±0

ANGULAR ± 1 °
DRAFT WHERE APPLICABLE
MUST REMAIN WITHIN DIMENSIONS

DIMENSION STYLE
MM ONLY

DRAWN BY	DATE	TITLE
JWK IM02	2014/11/12	040 WTB R/A SMT HEADER ASSY 56P
BCYOON	2014/11/12	
JYCH01	2014/12/31	

MATERIAL NO. SEE TABLE
SIZE A3
THIS DRAWING CONTAINS INFORMATION THAT IS PROPRIETARY TO MOLEX INCORPORATED AND SHOULD NOT BE USED WITHOUT WRITTEN PERMISSION

SCALE 1:1
DESIGN UNITS METRIC
THIRD ANGLE PROJECTION

molex

DOCUMENT NO. SD-104083-001_ SHEET NO. 1 OF 1