

SUMMARY

Wires

Low voltage 4



Image is for illustrative purpose only

Series 1S
Termination type Male solder
IP rating 50
AWG wire size 30.00 - 22.00
Cable Ø 4.20 - 5.20 mm
Status active
Matching parts [ERA.1S.304.CLL](#)

Download

[Request a quote](#)
[Eplan](#)
[Catalog](#)

TECHNICAL DETAILS

Mechanics

Shell Style/Model FFA*: Straight plug, cable collet and nut for fitting a bend relief
Keying Hermaphroditic keying (half moon insert) with male pin 1
Housing Material Brass (chrome plated [SAE AMS 2460]) shell and collet nut, nickel plated [SAE AMS QQ N 290] brass latch sleeve and mid pieces
Variant Z : Nut for fitting a bend relief
Weight 14.12 g

Performance

Configuration 1S.304 : 4 Low Voltage
Insulator L: PEEK (UL 94 / V-0/1.5)
Rated Current 10 Amps

Specifications

Contact Type: Solder
Contact Dia.: 0.9 mm (0.0354in)
Bucket Dia.: 0.8 mm (0.031in)
Max. Solid Conductor: 0.34 mm² (AWG 22)
R (max): 4.8 mOhm
Vtest: 1200 V (AC), 1800 V (DC)

LEMO products and services are provided "as is". LEMO makes no warranties or representations with regard to LEMO product & services or use of them, express, implied or statutory, including for accuracy, completeness, or security. The user is fully responsible for his products and applications using LEMO components.

Air clearance min.: 1.1 mm
Creepage distance min.: 1.1 mm

Others

Endurance (Shell): 5000 mating cycles
Temp (min / max): -55°C / +250°C
Humidity (max): <=95% [at 60 deg C / 140 F]
Vibration: 15 g [10 Hz - 2000 Hz]
Shock Resistance: 100 g [6 ms]
Climatical Category: 50/175/21
Shielding (min): 75 dB (10 MHz)
Shielding (min): 40 dB (1 GHz)
Salt Spray Corrosion: >144 hr

DRAWINGS

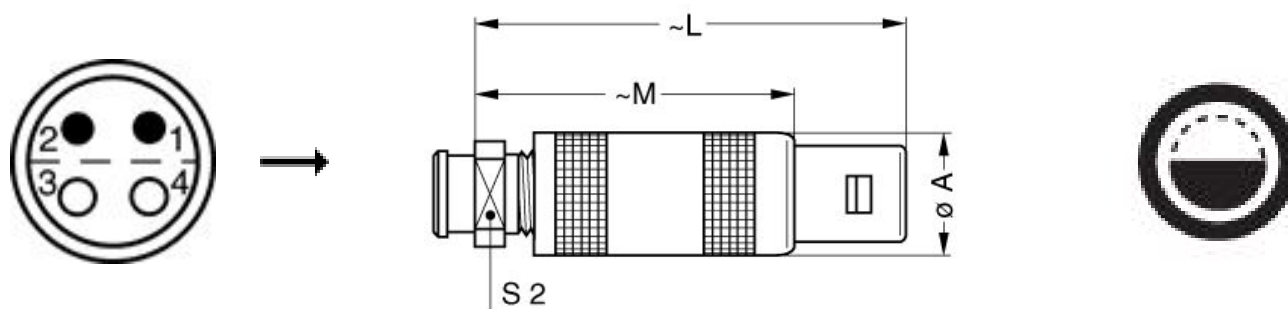

Dimensions

	A	L	M	S2
mm.	12	42.5	31.5	9
in.	0,47	1,67	1,24	0,35







RECOMMENDED BY LEMO

Tools

LEMO products and services are provided "as is". LEMO makes no warranties or representations with regard to LEMO product & services or use of them, express, implied or statutory, including for accuracy, completeness, or security. The user is fully responsible for his products and applications using LEMO components.

Spanner wrench: [DCD.1B.ZZZ.PA090](#)

Cables

CMN.04.T22.047QGC	TPR	Grey	
CMN.04.T22.048QGZE	TPR (medical)	Grey	
140240	PVC	Black	
140250	PVC	Grey	
40260	PVC	Black	
4080	PVC	Grey	
4221	PVC	Black	
4280	PVC	Black	
80080	PVC	Grey	
80082	PVC	Red	
80084	PVC	Black	

LEMO products and services are provided "as is". LEMO makes no warranties or representations with regard to LEMO product & services or use of them, express, implied or statutory, including for accuracy, completeness, or security. The user is fully responsible for his products and applications using LEMO components.