

REVISIONS				
ZONE	REV	DESCRIPTION	DATE	APPROVED

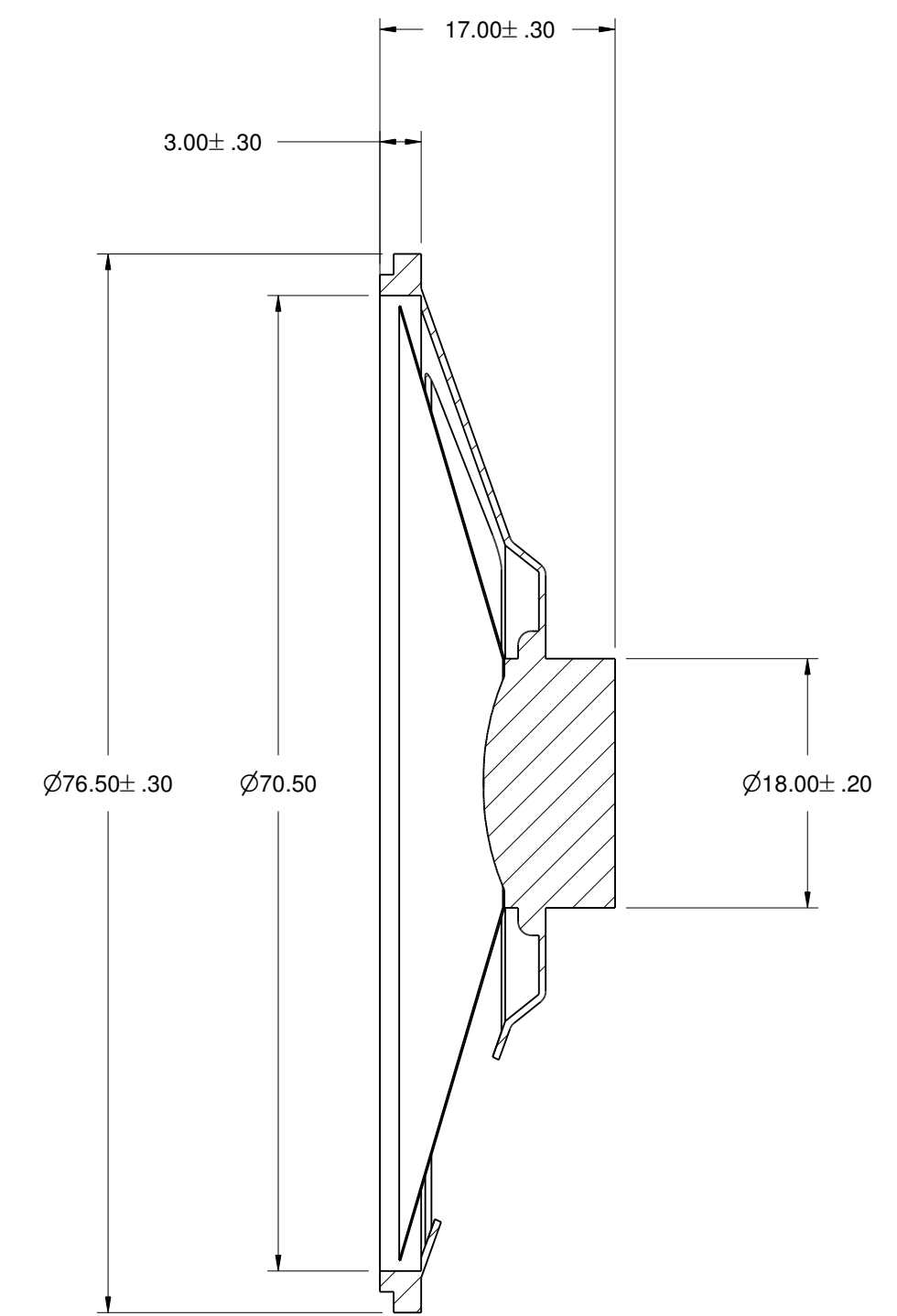

Section A-A

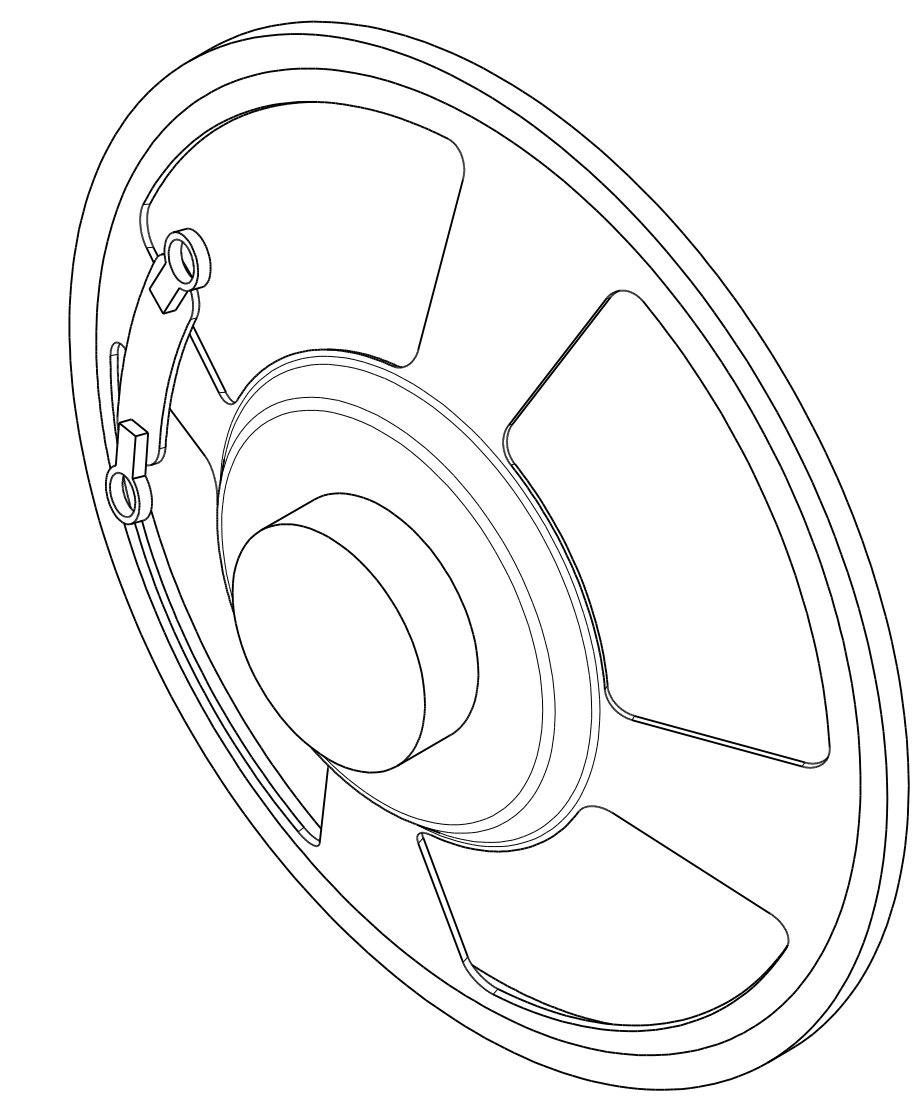
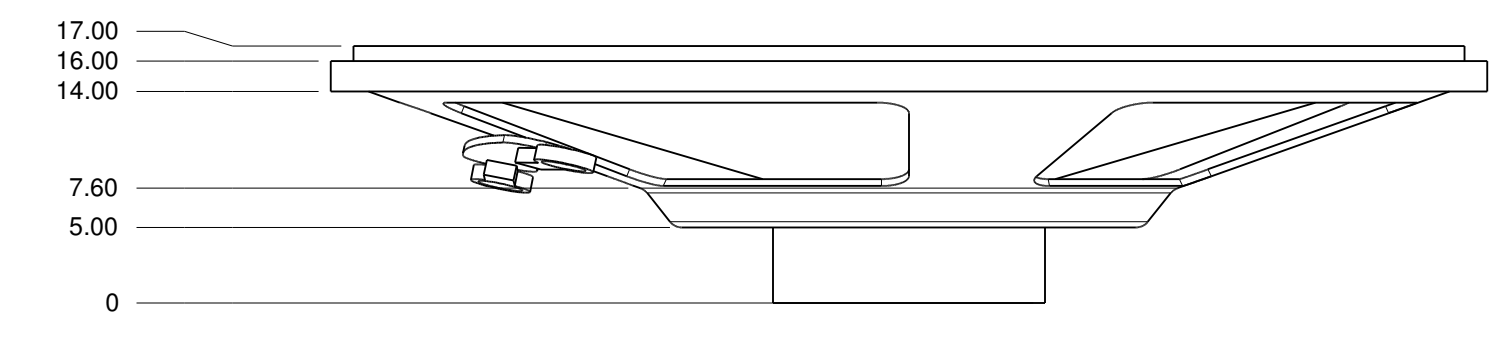
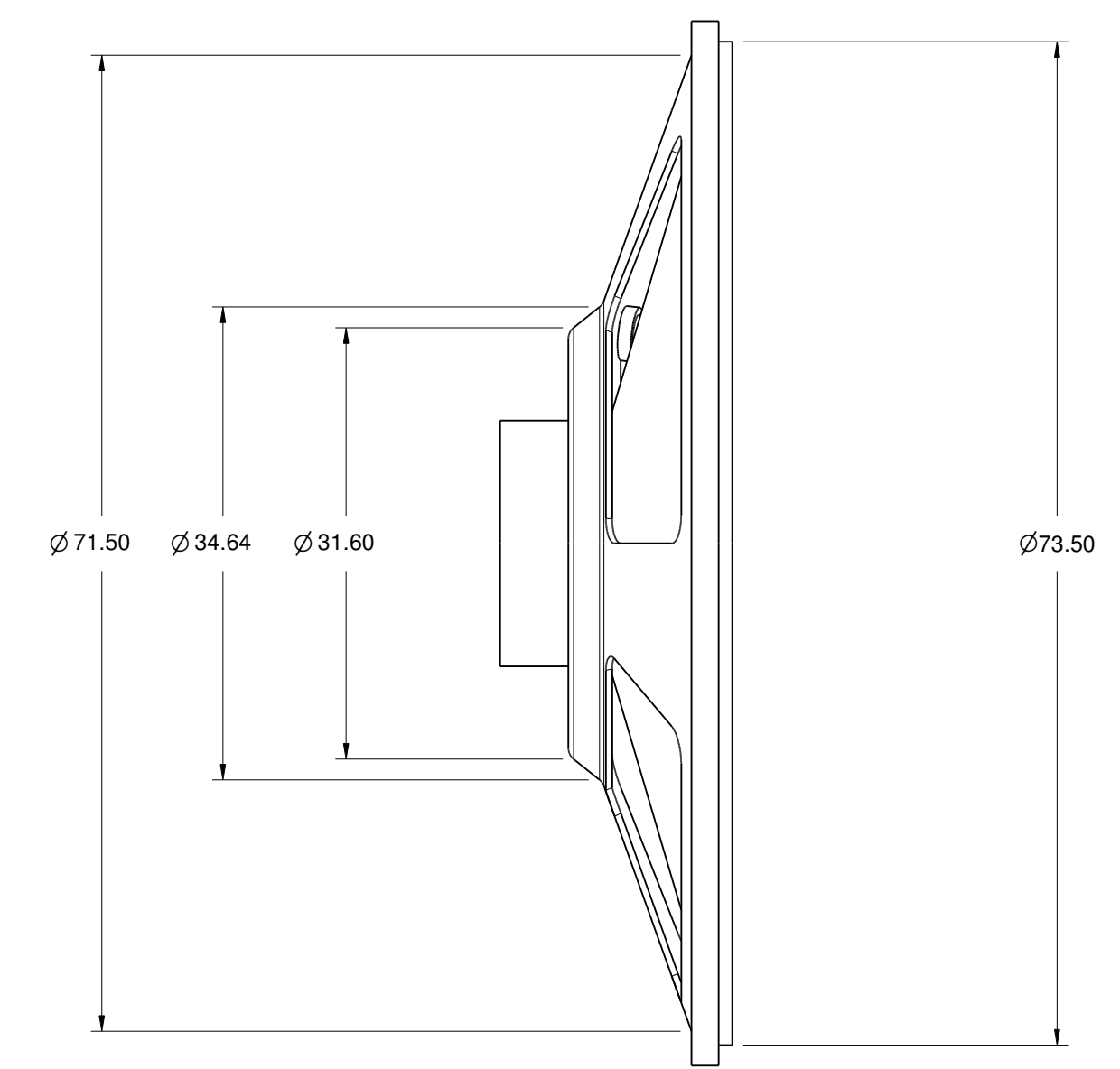
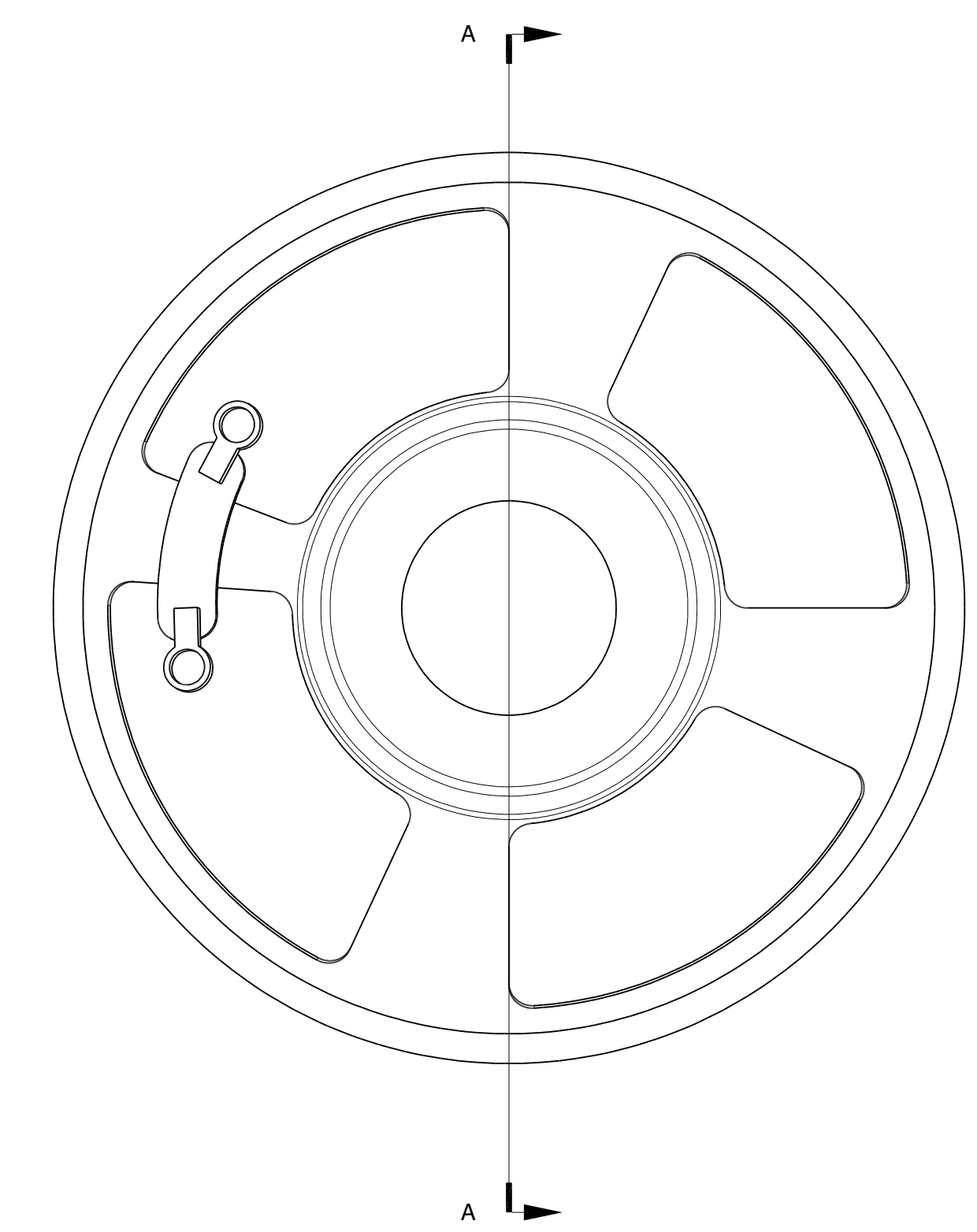

SIZE	FSCM NO.	DWG NO.	REV
D		WSP-7608	
SCALE	SHEET		1 OF 1
1:1			