

EC 1 12DC...

12 V DC electronic circuit breakers

Data sheet
3023_en_B

© PHOENIX CONTACT 2014-04-09



1 Description

The EC 1 12DC... electronic circuit breakers selectively protect 12 V DC load circuits in hazardous and non-hazardous environments. A combination of an active electronic current limit for short circuits and an overload shutdown ensures that the EC 1 12DC... will quickly react to an over-current condition in the protected circuit.

Current limitation restricts fault current to 1.5 - 1.8 times the nominal current rating (I_N). As a result, the EC 1 12DC... can prevent the loss of the DC output voltage sometimes experienced when a faulted circuit triggers a switched-mode power supply into self-protected output-shutdown mode. Capacitive loads of up to 75,000 μF can be protected.

The EC 1 12DC... electronic circuit breakers are available with nominal current ratings from 1 to 10 A. Local status indication is provided by a multi-color LED, and remote status indication is available via status output (+12 V = OK). Manual on/off and reset is accomplished using the integrated slide switch. Remote reset (EC 1 12DC... S-R) and remote on/off (EC 1 12DC... S-C) versions are available.

The EC 1 12DC... can be snapped onto 35 mm mounting rails (EN 50022) for fast and easy installation. At just 12.5 mm wide, it requires only a small space on the rail.

Screw connection technology provides secure and reliable wire connection.

The integrated current distribution system is another advantage of the EC 1 12DC... circuit breakers. Wiring can be implemented easily using available busbar.

2 Features

- Selective load protection
- Current limitation on overload/short circuits
- Protection for capacitive circuits up to 75,000 μF
- Current ratings from 1 to 10 A
- Manual on/off/reset slide switch
- Electronic reset option
- Electronic on/off option
- 12.5 mm width for minimal rail footprint
- Bridging available for line (+) and return (-)
- Remote status indication (+12 V = OK)
- Multi-color status LEDs



This equipment is suitable for use in Class I, Division 2, Groups A, B, C, D or non-hazardous locations only.



Make sure you always use the latest documentation. It can be downloaded at phoenixcontact.com.



This data sheet is valid for all products listed on the following page:

3 Ordering data

Products

Description	Type	Order No.	Pcs. / Pkt.
Electronic circuit breaker, 1 A, 12 V DC, on/off control input and status output	EC 1 12DC/1A S-C	3000754	1
Electronic circuit breaker, 2 A, 12 V DC, on/off control input and status output	EC 1 12DC/2A S-C	3000755	1
Electronic circuit breaker, 3 A, 12 V DC, on/off control input and status output	EC 1 12DC/3A S-C	3000756	1
Electronic circuit breaker, 4 A, 12 V DC, on/off control input and status output	EC 1 12DC/4A S-C	3000757	1
Electronic circuit breaker, 6 A, 12 V DC, on/off control input and status output	EC 1 12DC/6A S-C	3000758	1
Electronic circuit breaker, 10 A, 12 V DC, on/off control input and status output	EC 1 12DC/10A S-C	3000759	1
Electronic circuit breaker, 1 A, 12 V DC, reset input and status output	EC 1 12DC/1A S-R	3000760	1
Electronic circuit breaker, 2 A, 12 V DC, reset input and status output	EC 1 12DC/2A S-R	3000761	1
Electronic circuit breaker, 3 A, 12 V DC, reset input and status output	EC 1 12DC/3A S-R	3000762	1
Electronic circuit breaker, 4 A, 12 V DC, reset input and status output	EC 1 12DC/4A S-R	3000763	1
Electronic circuit breaker, 6 A, 12 V DC, reset input and status output	EC 1 12DC/6A S-R	3000765	1
Electronic circuit breaker, 10 A, 12 V DC, reset input and status output	EC 1 12DC/10A S-R	3000766	1

Accessories

Description	Type	Order No.	Pcs. / Pkt.
Busbar, 500 mm, can be cut to length, gray	FBST 500 TMC-N GY	0901028	10

4 Technical data



Data values at $T_A = 25^\circ\text{C}$, $U_S = 12\text{ V DC}$

Operating data

Nominal voltage U_S	12 V DC
Voltage range	9 ... 18 V DC
Nominal current I_N	See "Current rating" on page 3
Closed-circuit current I_0	When on: 15 ... 20 mA typical
Shutdown time, typical	3 s at $I_{\text{Load}} > 1.1 \times I_N$ 50 ms ... 3 s at $I_{\text{Load}} > 1.8 I_N$ (or $1.5 \times I_N$)

Load circuit

Load output	Power MOSFET switching output (positive switching)
Overload shutdown	Typically $1.1 \times I_N$ ($1.05 \dots 1.35 \times I_N$)
Short-circuit current I_K	Active current limitation (see "Current rating" on page 3)
Temperature shutdown	Internal temperature monitoring with electronic disconnect
Undervoltage monitoring for load output after each switch-on procedure	With hysteresis at voltage dips <500 ms, no reset required: load "off" at $U_B < 3.2\text{ V}$
Switch-on delay t_{Start} (typical)	10 ms
Free running circuit	External free-wheeling diode recommended for inductive load
Parallel connection of multiple load outputs	Not permitted

Connection data**Line+/Load+/0 V**

Thread size	M4
Conductor size	
1 solid or stranded conductor	0.5 ... 10 mm ² with or without ferrule
2 solid or stranded conductors with same cross-section	0.5 ... 4 mm ² without ferrule; 0.5 ... 2.5 mm ² with ferrule
2 stranded conductors with TWIN ferrule	0.5 ... 6 mm ²
Stripping length	10 mm
Tightening torque	1.5 ... 1.8 Nm

Signal connections

Thread size	M3
Stranded conductor size with ferrule	0.25 ... 2.5 mm ²
Stripping length	8 mm
Tightening torque	0.5 ... 0.6 Nm

General data

Mounting	DIN rail in acc. with EN 50072 (NS 35 x 7.5)
Degree of protection	IP20
Temperature range, operation	
Ordinary location	-20 ... 60°C
Hazardous location (Class I, Div. 2)	0 ... 25°C
Temperature range, storage	-20 ... 70°C
Weight	65 g

Status and control

Status LED	<p>Green: power applied</p> <p>Orange: overload or short circuit leading to electronic shutdown condition</p> <p>Red: electronically disconnected; low voltage (<3.25 V); load circuit/power-MOSFET off</p> <p>Off: under voltage or no power; manually switched off</p>
Terminals	
Gnd (-)	Pin 3
NC signal contacts	-
NO signal contacts	-
Remote control/reset	Pin 21/22
Status output	Pin 23
Switching capacity I _{CN}	Active current limitation
Expected life with 1 x I _N	10000 cycles

Current rating

Current rating, I _N (A)	1	2	3	4	6	10
Voltage drop, typical, at I _N (mV)	80	130	80	100	130	150
Active current limitation, typical	1.8 x I _N	1.8 x I _N	1.8 x I _N	1.8 x I _N	1.8 x I _N	1.5 x I _N
Maximum load current at 40°C at 100% duty cycle (A)	1	2	3	4	6	10
Maximum load current at 50°C at 100% duty cycle (A)	1	2	3	4	5	9

Approval/conformance

Vibration	3g tested in acc. with IEC 60068-2-6, test Fc
Conformance with EMC Directive 2004/108/EC	Noise emission: EN 61000-6-3 Noise susceptibility: EN 61000-6-2
Insulation coordination (IEC 60934)	0.5 kV/2 pollution degree 2, increased insulation in actuation area

Approval/conformance

Dielectric strength	18 V DC maximum (load circuit)
Insulation resistance (off state)	None (electronic shutdown only)
Approvals	<p>CE</p> <p>SSOP Solid state overcurrent protector (UL 2367)</p> <p>Class I, Division 2, Groups A,B,C,D T5 (UL 1604)</p>

Voltage drop, current limitation, maximum load current

Nominal current I_N	Voltage drop U_{ON} at I_N (typical)	Active current limitation (typical)	Maximum load current at 100% on duty	
			$T_A = 40^\circ\text{C}$	$T_A = 50^\circ\text{C}$
1 A	80 mV	$1.8 \times I_N$	1 A	1 A
2 A	130 mV	$1.8 \times I_N$	2 A	2 A
3 A	80 mV	$1.8 \times I_N$	3 A	3 A
4 A	100 mV	$1.8 \times I_N$	4 A	4 A
6 A	130 mV	$1.8 \times I_N$	6 A	5 A
10 A	150 mV	$1.5 \times I_N$	10 A	9 A



When mounted side-by-side without airflow between the electronic circuit breakers, current load should be reduced to 80% of rated load when operating at a 100% duty cycle.

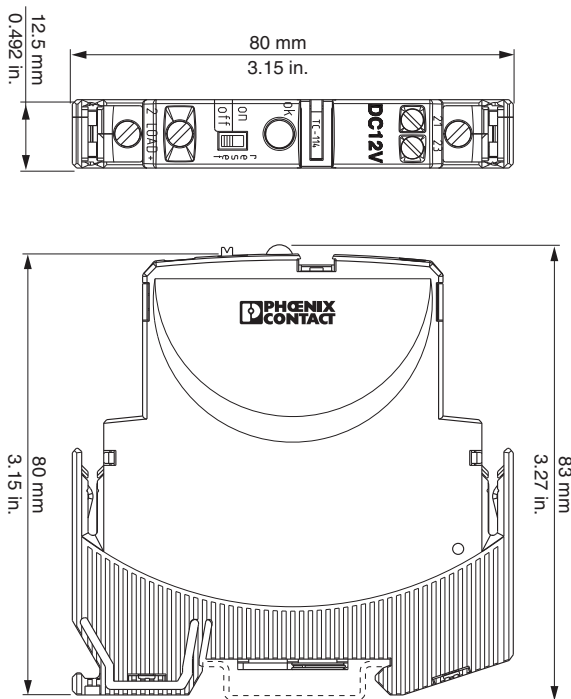

Figure 1 Dimensions

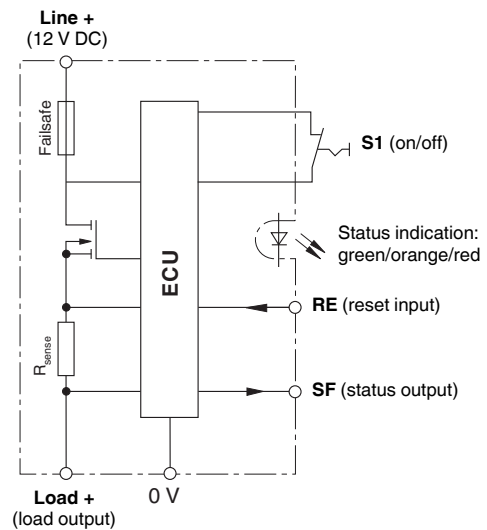

Figure 2 Circuit diagram

5 Operating characteristics

5.1 Information required for UL approval



WARNING:

Exposure to some chemicals may degrade the sealing properties of materials used in EC 1 12DC.... These products use the following materials:

Sealing material:

- Generic name: Modified diglycidyl ether of bisphenol A
- Supplier: Fine Polymers Corporation
- Type: Epi Fine 4616L-160PK

Casing material:

- Generic name: Liquid crystal polymer
- Supplier: Sumitomo Chemical
- Type: E4008, E4009 or E6008

Periodically inspect the EC 1 12DC... for any degradation of properties and replace if degradation is found.



WARNING: Explosion hazard

Do not disconnect equipment unless power has been removed or the area is known to be non-hazardous.

Substitution of any components may impair suitability for hazardous locations.

5.2 Time/current characteristics

The trip time is typically 3 s in the range between 1.1 and 1.8 x I_N¹.

Electronic current limitation typically occurs at 1.8 x I_N which means that, under all overload conditions (independent of the power supply and the resistance of the load circuit), the maximum overload before disconnection will not exceed 1.8 x I_N times the current rating. Trip time is between 100 ms and 3 s (depending on overload or at short circuit).

Without this current limitation, a considerably higher overload current would flow in the event of an overload or short circuit.

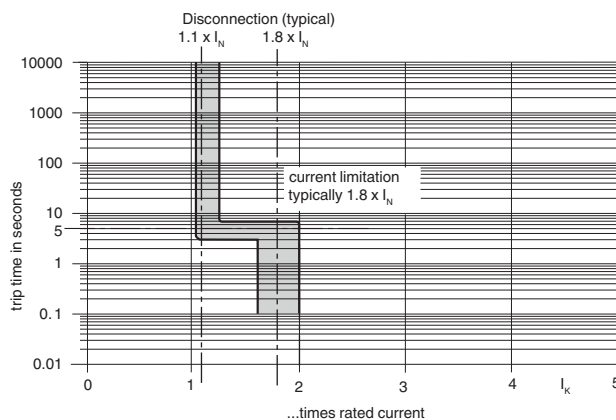



Figure 4 Time/current characteristic curve



Electronic Circuit Protector
EC-E, EC-E1, EC-E4, EC1

 UL1604
 This device is suitable for use in Class I, Div 2, Groups A, B, C, D;
 TC T5; UL File# E324415

Warnings:

1. Remove power before disconnecting device.
2. Components substitutions may impair suitability of Class I, Div 2.
3. Chemical exposure may degrade internal relay's sealing property in the EC-E1 and EC-E4 products only.

 UL2367
 Non-hazardous use - UL File# E317172

Refer to data sheet / installation guidelines for installation and safety instructions.

PHOENIX CONTACT GmbH & Co.KG
 Flachsmarktstraße 8
 32825 Blomberg - Germany
 Phone +49-(0)5235-3-00
 Fax +49-(0)5235-3-4 1200

Figure 3 UL-approved package slip

¹ Current limitation is typically 1.8 x I_N times rated current at I_N = 0.5 A to 6 A
 Current limitation is typically 1.5 x I_N times rated current at I_N = 8 A or 10 A

6 Installation

The EC 1 12DC... features an integrated power distribution system.

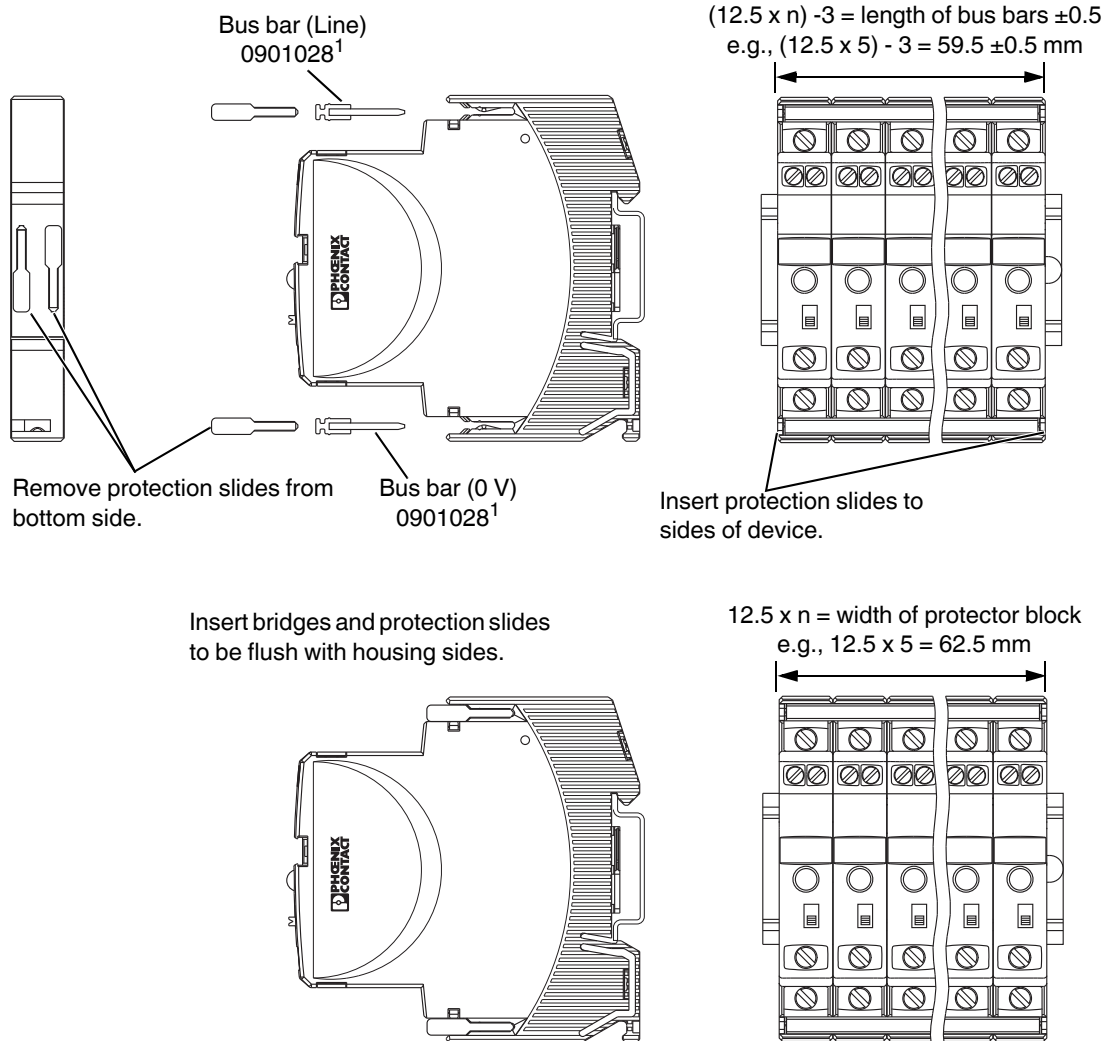

¹ $I_{MAX} = 50$ A when connected with a single input wire to the center of the bar
 $I_{MAX} = 63$ A when connected with two input wires, one at each end of the bar

Figure 5 Mounting options and components



NOTE:

A 0 V connection is required for the EC 1 12DC....
 A maximum of 10 insertion/removal cycles are allowed for busbars.



When mounted side-by-side without airflow between the electronic circuit breakers, current load should be reduced to 80% of rated load when operating at a 100% duty cycle.
 Busbars should be interrupted and re-connected every 10 devices.



WARNING:

Ensure that all personnel are clear before applying a reset to multiple circuit breakers. While breakers that are on will be unaffected, any breakers that were electronically tripped due to an overload condition will be turned on.

When the breaker is on, 12 V DC is available at the Status Output (terminal 23) (see Figure 2 for terminal locations).

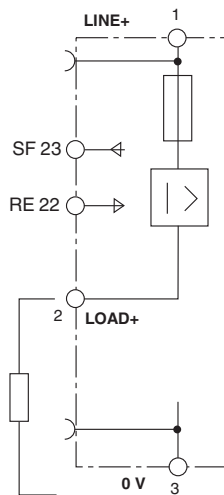

Figure 6 EC 1 12DC... S-R signal inputs/outputs

EC 1 12DC... S-R breakers with remote reset option may be remotely reset by the trailing edge of a +12 V DC pulse applied to the Reset Input (terminal 22).

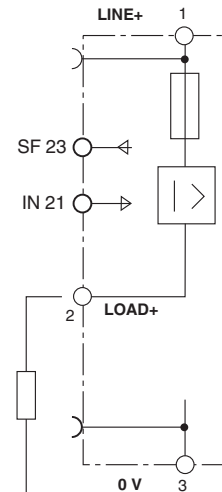

Figure 7 EC 1 12DC... S-C signal inputs/outputs

EC 1 12DC... S-C breakers with remote control option may be turned on/off by cycling the +12 V DC applied to terminal 21.