

5 CONTACTS
 BLUE MALE HOUSING FOR WIRE INSULATION Ø1.30 TO Ø1.70

TOLERANCE UNLESS OTHERWISE SPECIFIED	
.X	±0.38
.XX	±0.25
.XXX	±0.13

THIS IS A C.A.D. GENERATED DRAWING
 DO NOT MAKE MANUAL REVISIONS TO MASTER.



ISSUE NUMBER	
ORIGINAL	①

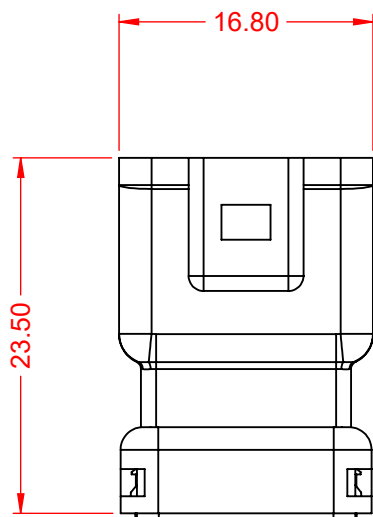
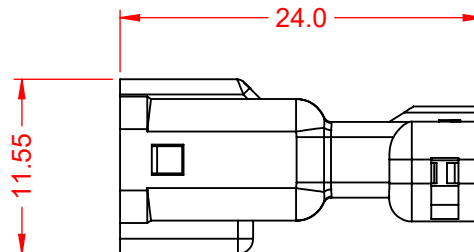
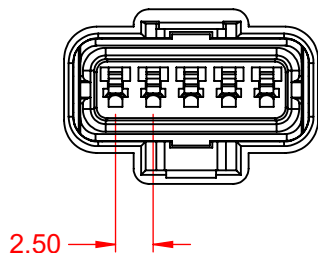

ISO 1:1

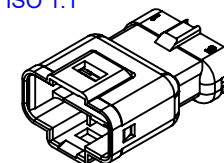

NOTE:

ELECTRICAL SPECIFICATIONS:

VOLTAGE RATING:	250V MAX.
CURRENT RATING:	3A per CONTACT
CONTACT RESISTANCE:	15mΩ MAX.
INSULATOR RESISTANCE:	1000MΩ min.
DIELECTRIC WITHSTANDING VOLTAGE:	1000V AC(RMS)
OPERATING TEMPERATURE:	-40°C ~ 105°C

MATERIAL & FINISH:

HOUSING:	PBT, UL94V-0
CONTACTS:	PHOSPHOR BRONZE, TIN PLATED
SEALS:	SILICONE RUBBER



THIS SERIES FULLY CONFORMS TO
 THE EUROPEAN UNION DIRECTIVES
 2011/65/EU FOR RoHS COMPLIANCY.



YOUR CONNECTION TO QUALITY & SERVICE

EDAC INC
 TORONTO, ONTARIO
 CANADA

THESE DRAWINGS AND SPECIFICATIONS
 ARE THE PROPERTY OF EDAC INC., AND
 SHALL NOT BE REPRODUCED, OR COPIED
 OR USED AS THE BASIS FOR THE
 MANUFACTURE OR SALE OF APPARATUS
 WITHOUT WRITTEN PERMISSION.

560 SERIES WATERPROOF CONNECTOR

ACAD REFERENCE NO.: 560 Assembly	
DRAWN: C.B	DATE: July 23, 2020
CHECKED:	DATE:
SCALE: 2:1	SHEET 1 OF 1
DRAWING NUMBER: 560 Assembly	ISSUE
PART NUMBER: 560-005-000-311	1