

EZO-DO™

Embedded Dissolved Oxygen Circuit

Reads	Dissolved Oxygen
Range	0.01 – 100+ mg/L 0.1 – 400+ % saturation
Accuracy	+/- 0.05 mg/L
Response time	1 reading per sec
Supported probes	Any galvanic probe
Calibration	1 or 2 point
Temperature, salinity and pressure compensation	Yes
Data protocol	UART & I²C
Default I ² C address	97 (0x61)
Operating voltage	3.3V – 5V
Data format	ASCII

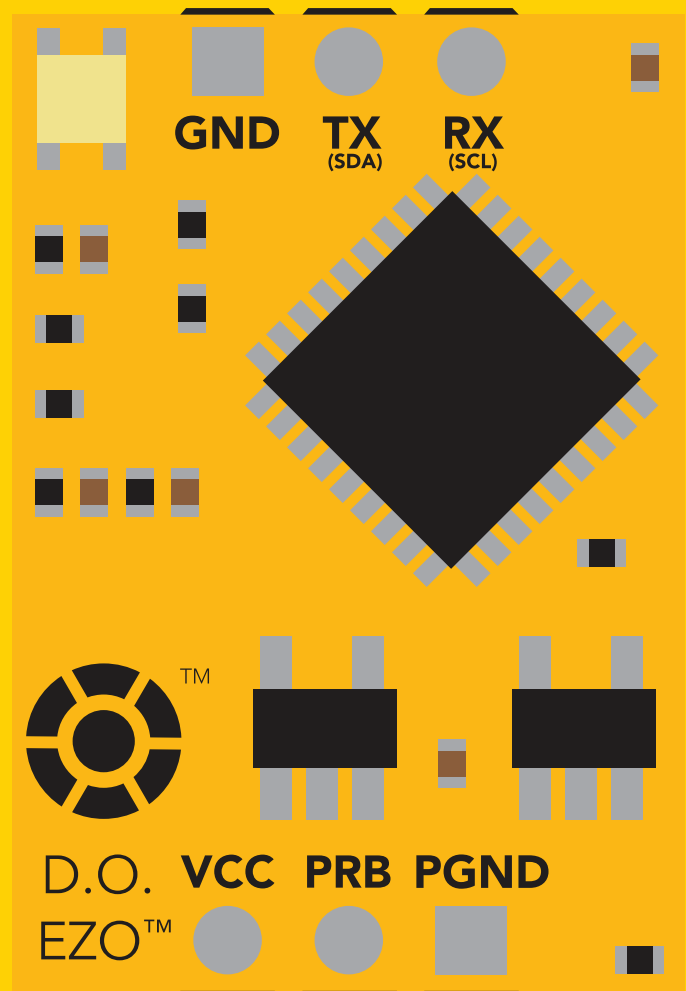

PATENT PROTECTED



STOP

SOLDERING THIS DEVICE VOIDS YOUR WARRANTY.

This is sensitive electronic equipment. Get this device working in a solderless breadboard first. Once this device has been soldered it is no longer covered by our warranty.

This device has been designed to be soldered and can be soldered at any time. Once that decision has been made, Atlas Scientific no longer assumes responsibility for the device's continued operation. The embedded systems engineer is now the responsible party.

Get this device working in a solderless breadboard first!

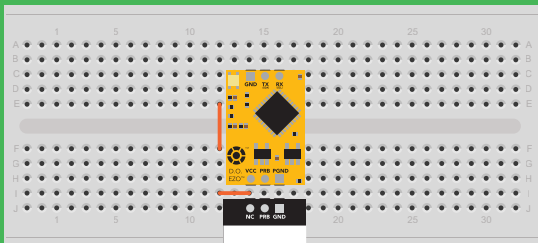

Do not embed this device without testing it in a solderless breadboard!

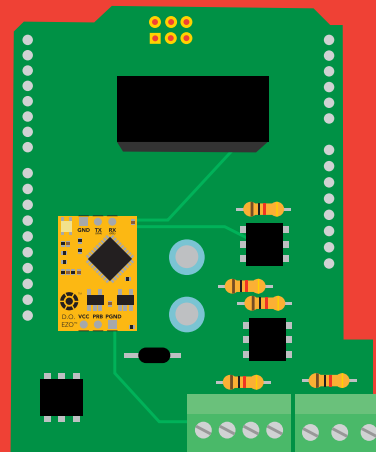

Table of contents

Circuit dimensions	4	Correct wiring	8
Power consumption	4	Calibration theory	9
Absolute max ratings	4	Preserve calibration solution	12
Operating principle	5	Default state	13
Power and data isolation	6	Available data protocols	14

UART

UART mode	16
Receiving data from device	17
Sending commands to device	18
LED color definition	19
UART quick command page	20
LED control	21
Find	22
Continuous reading mode	23
Single reading mode	24
Calibration	25
Export calibration	26
Import calibration	27
Temperature compensation	28
Salinity compensation	29
Pressure compensation	30
Enable/disable parameters	31
Naming device	32
Device information	33
Response codes	34
Reading device status	35
Sleep mode/low power	36
Change baud rate	37
Protocol lock	38
Factory reset	39
Change to I²C mode	40
Manual switching to I²C	41

I²C

I²C mode	43
Sending commands	44
Requesting data	45
Response codes	46
LED color definition	47
I²C quick command page	48
LED control	49
Find	50
Taking reading	51
Calibration	52
Export calibration	53
Import calibration	54
Temperature compensation	55
Salinity compensation	56
Pressure compensation	57
Enable/disable parameters	58
Naming device	59
Device information	60
Reading device status	61
Sleep mode/low power	62
Protocol lock	63
I²C address change	64
Factory reset	65
Change to UART mode	66
Manual switching to UART	67

Circuit footprint	68
Datasheet change log	69
Warranty	73

EZO™ circuit dimensions

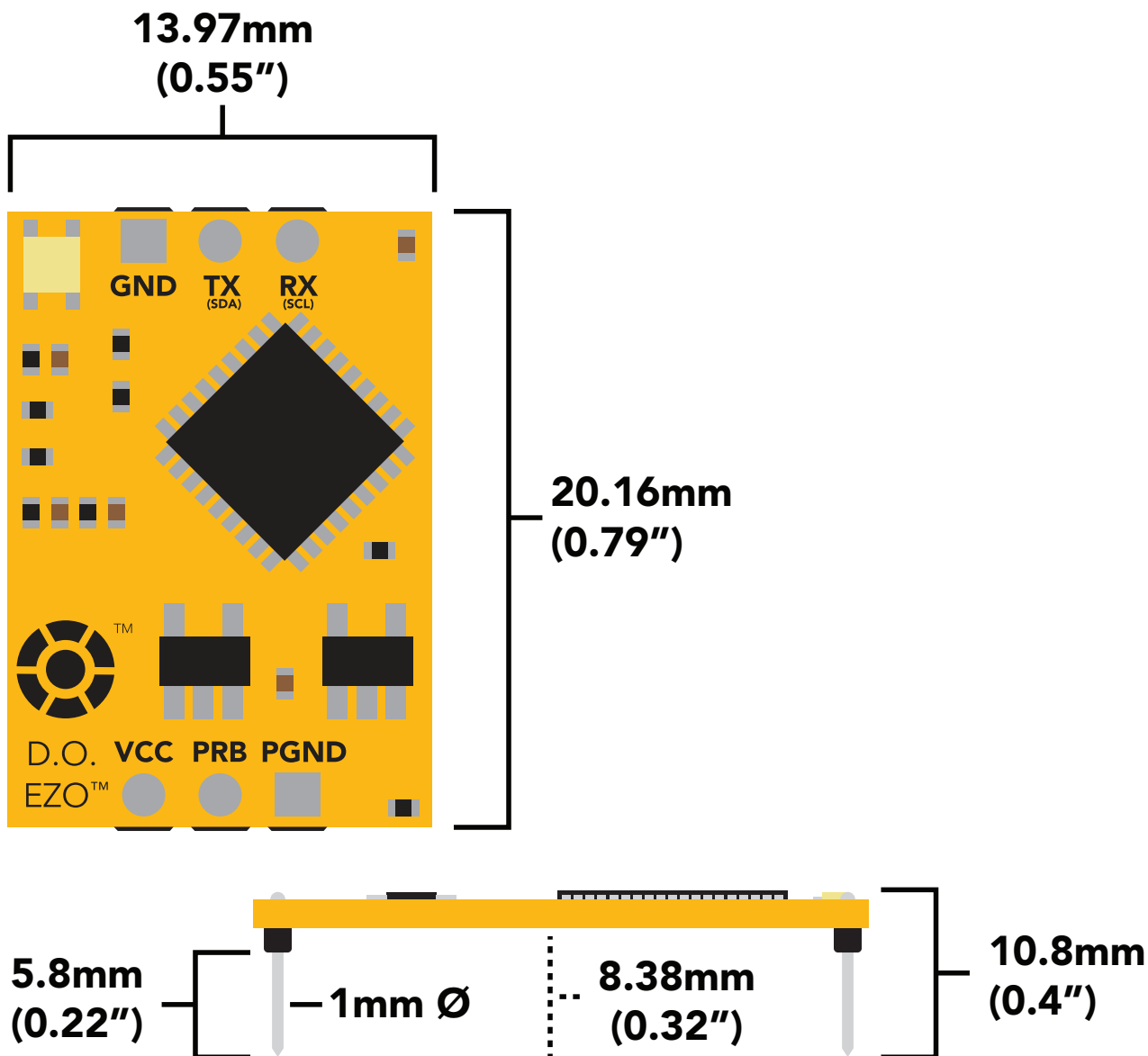

Power consumption

	LED	MAX	STANDBY	SLEEP
5V	ON	13.5 mA	13.1 mA	0.66 mA
	OFF	12.7 mA	12.7 mA	
3.3V	ON	12.1 mA	12 mA	0.3 mA
	OFF	11.9 mA	11.9 mA	

Absolute max ratings

Parameter	MIN	TYP	MAX
Storage temperature (EZO™ D.O.)	-65 °C		125 °C
Operational temperature (EZO™ D.O.)	-40 °C	25 °C	85 °C
VCC	3.3V	5V	5.5V

Operating principle

The Atlas Scientific™ EZO™ Dissolved Oxygen circuit works with:

- X Optical probe** Slow response, requires external power, expensive.
- X Polar Graphic probe** Requires external power, output in μA .
- ✓ Galvanic probe** Requires no external power, output in mV.

A galvanic dissolved oxygen probe consists of a PTFE membrane, an anode bathed in an electrolyte and a cathode. Oxygen molecules diffuse through the probe's membrane at a constant rate (without the membrane the reaction happens too quickly). Once the oxygen molecules have crossed the membrane they are reduced at the cathode and a small voltage is produced. If no oxygen molecules are present, the probe will output 0 mV. As the oxygen increases so does the mV output from the probe. Each probe will output a different voltage in the presence of oxygen. The only thing that is constant is that **0mV = 0 Oxygen**. (A galvanic dissolved oxygen probe can also be used to detect the Oxygen content in gases).

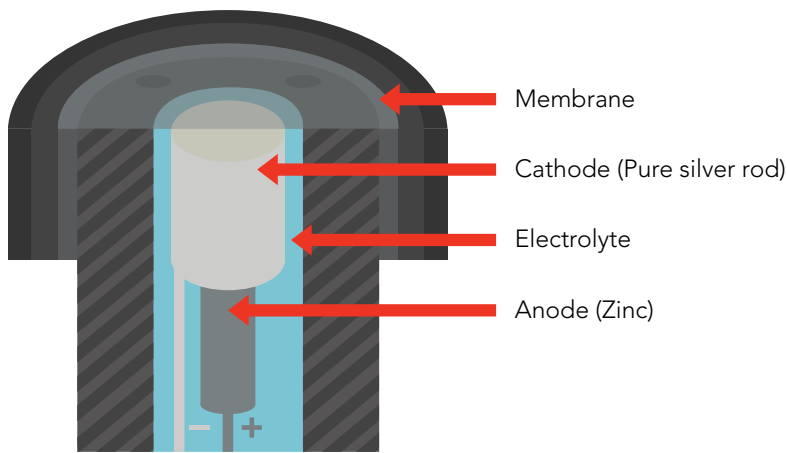

Flow Dependence

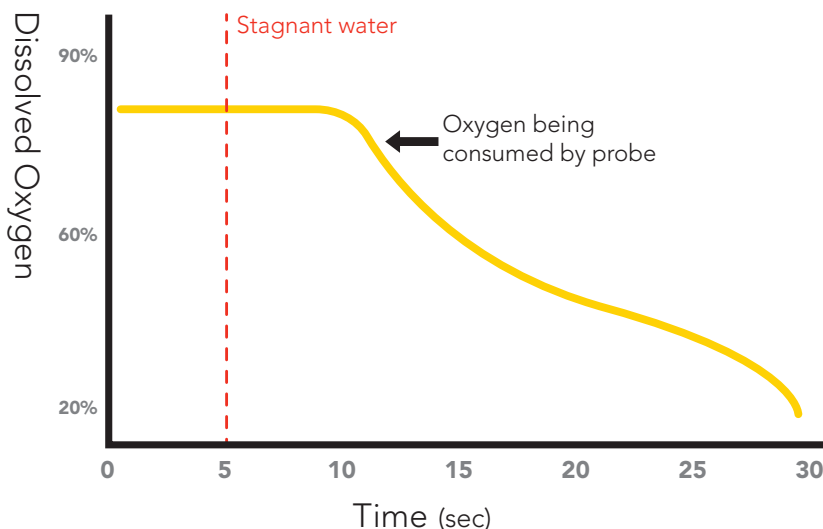

One of the drawbacks from using a galvanic probe is that it consumes a **VERY** small amount of the oxygen it reads. Therefore, a small amount of water movement is necessary to take accurate readings. **Approximately 60 ml/min.**

Power and data isolation

The Atlas Scientific EZO™ Dissolved Oxygen circuit is a very sensitive device. This sensitivity is what gives the Dissolved Oxygen circuit its accuracy. This also means that the Dissolved Oxygen circuit is capable of reading micro-voltages that are bleeding into the water from unnatural sources such as pumps, solenoid valves or other probes/sensors.

When electrical noise is interfering with the Dissolved Oxygen readings it is common to see rapidly fluctuating readings or readings that are consistently off. To verify that electrical noise is causing inaccurate readings, place the Dissolved Oxygen probe in a cup of water by itself. The readings should stabilize quickly, confirming that electrical noise was the issue.



When reading Dissolved Oxygen and Conductivity together, it is **strongly recommended** that the EZO™ Dissolved Oxygen circuit is electrically isolated from the EZO™ Conductivity circuit.

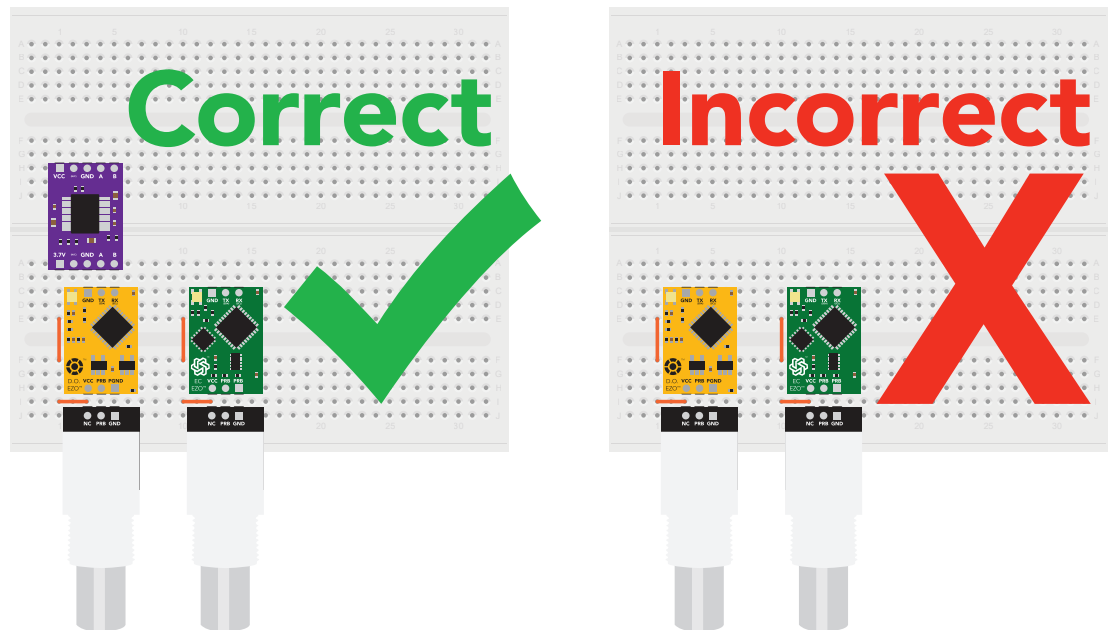

Without isolation, Conductivity readings will effect Dissolved Oxygen accuracy.

This schematic shows exactly how we isolate data and power using the and a few passive components. The ADM3260 can output isolated power up to 150 mW and incorporates two bidirectional data channels.

This technology works by using tiny transformers to induce the voltage across an air gap. PCB layout requires special attention for EMI/EMC and RF Control, having proper ground planes and keeping the capacitors as close to the chip as possible are crucial for proper performance. The two data channels have a 4.7kΩ pull up resistor on both the isolated and non-isolated lines (R1, R2, R3, and R4) The output voltage is set using a voltage divider (R5, R6, and R7) this produces a voltage of 3.9V regardless of your input voltage.

Isolated ground is different from non-isolated ground, these two lines should not be connected together.

VCC = 3.0v – 5.5v

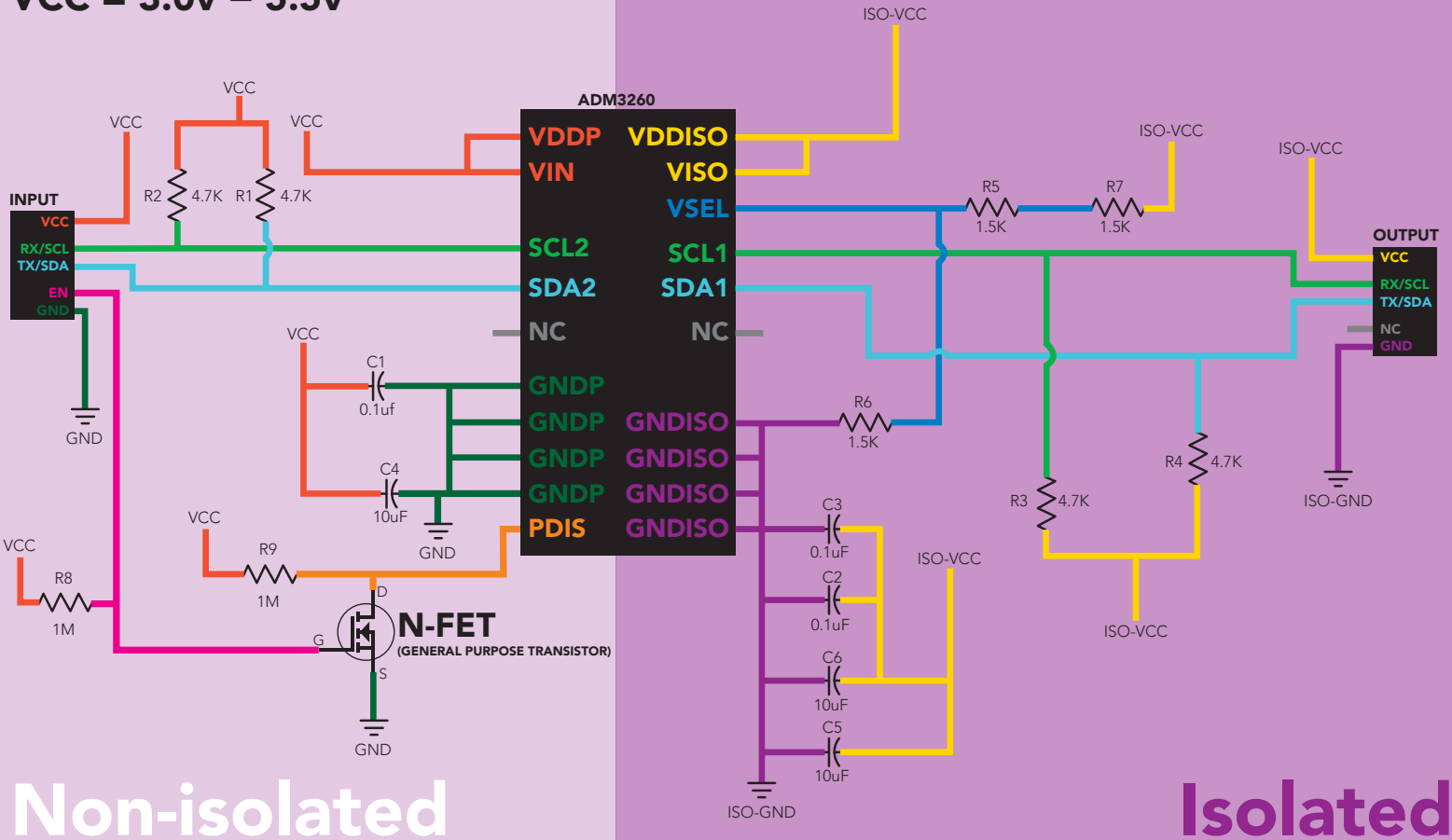

✓ Correct wiring

Bread board

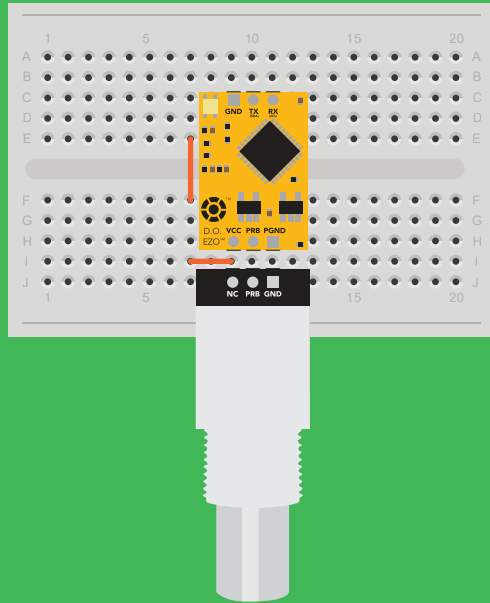

Bread board via USB

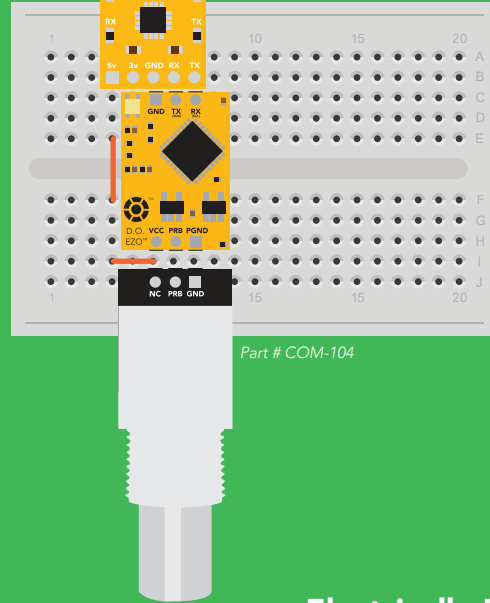

Part # COM-104

Carrier board

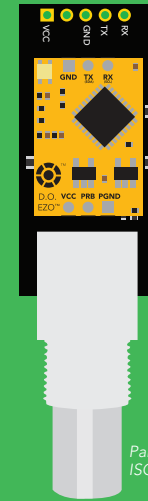

Part # ISCCB

USB carrier board

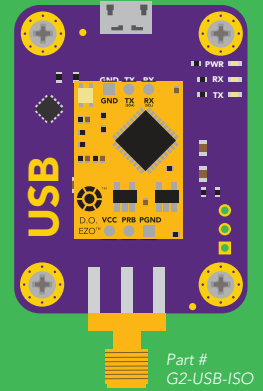

Part # G2-USB-ISO

Electrically Isolated EZO™ Carrier Board

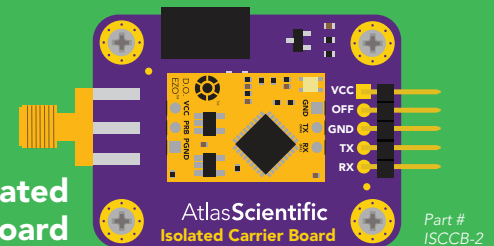

Part # ISCCB-2

X Incorrect wiring

Extended leads

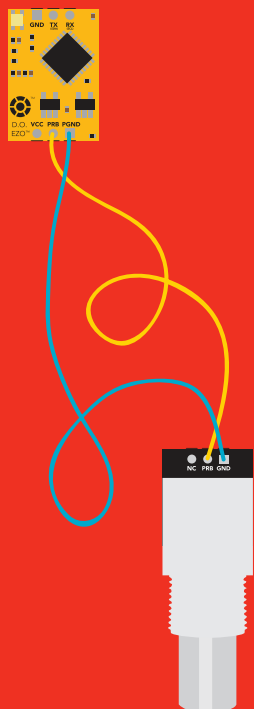

Sloppy setup

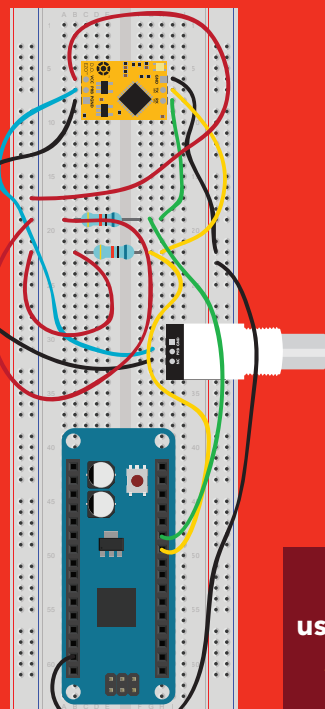

Perfboards or Protoboards

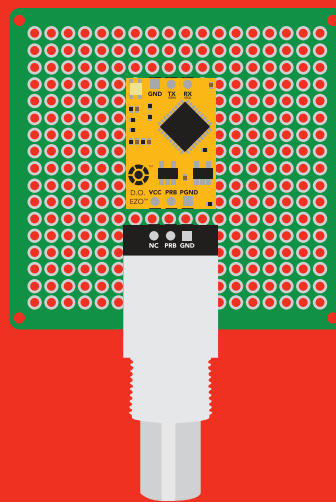

NEVER
use Perfboards or Protoboards

Flux residue and shorting wires make it very hard to get accurate readings.

*Embedded into your device

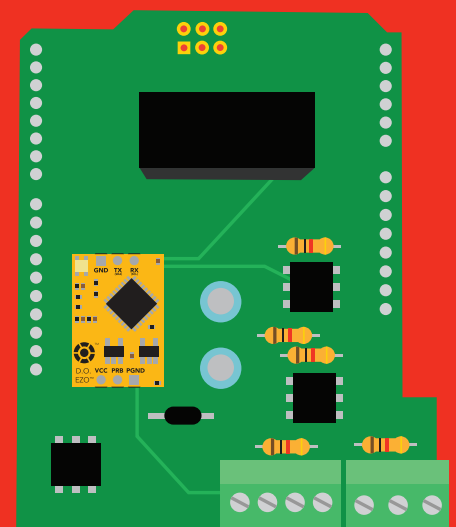

***Only after you are familiar with EZO™ circuits operation**

Calibration theory

Simple calibration

UART mode

Continuous readings

Advanced calibration

I²C mode

Continuously request readings

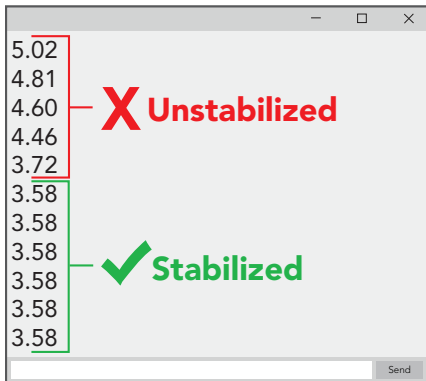

The most important part of calibration is watching the readings during the calibration process.

It's easiest to calibrate the device in its default state (UART mode, with continuous readings enabled).

Switching the device to I²C mode after calibration **will not** affect the stored calibration. If the device must be calibrated in I²C mode be sure to **continuously request readings** so you can see the output from the probe.



The Atlas Scientific EZO™ Dissolved Oxygen circuit, has a flexible calibration protocol, allowing for **single point** or **dual point (optional)** calibration.

Calibrate first, compensate later.

Temperature, salinity and pressure compensation values have no effect on calibration.



Single point calibration

Let the Dissolved Oxygen probe sit, exposed to air until the readings stabilize. (*small movement from one reading to the next is normal*).

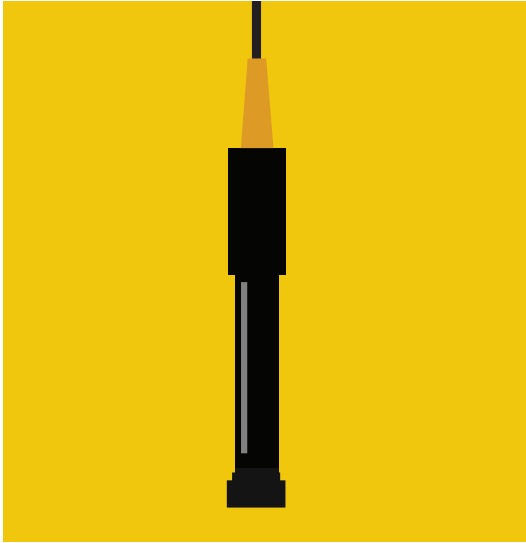

```
15.03
14.45 — X Unstabilized
14.08
13.95
13.95 — ✓ Stabilized
13.95
13.95
cal
*OK
9.09
9.09
```

Once the readings have stabilized, issue the calibration command. **"cal"**

After calibration is complete, you should see readings between **9.09 – 9.1X mg/L**.
(only if temperature, salinity and pressure compensation are at default values)

Dual point calibration (optional)

Only perform this calibration if you require accurate readings **below 1.0 mg/L**

After you have calibrated the EZO™ Dissolved Oxygen circuit using the "Cal" command; Place the probe into the Zero Dissolved Oxygen calibration solution and stir the probe around to remove trapped air (which could cause readings to go high). Let the probe sit in Zero D.O. calibration solution until readings stabilize. (small movement from one reading to the next is normal).

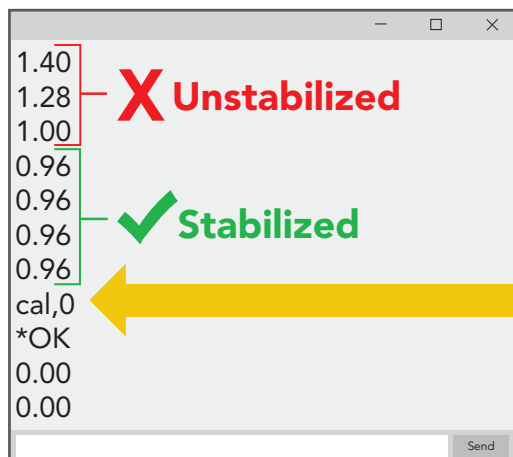
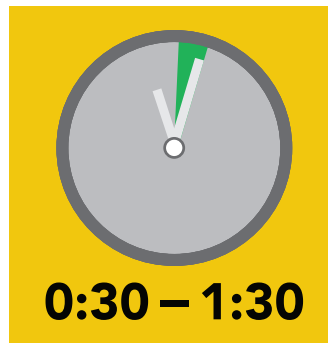

Once the readings have stabilized, issue the calibration command. **"cal,0"**

How to preserve the Zero D.O. calibration solution

Oxygen is everywhere. The Zero D.O. calibration solution has been designed to chemically absorb oxygen. Once the bottle has been opened the test solution has been exposed to oxygen and will slowly stop working.

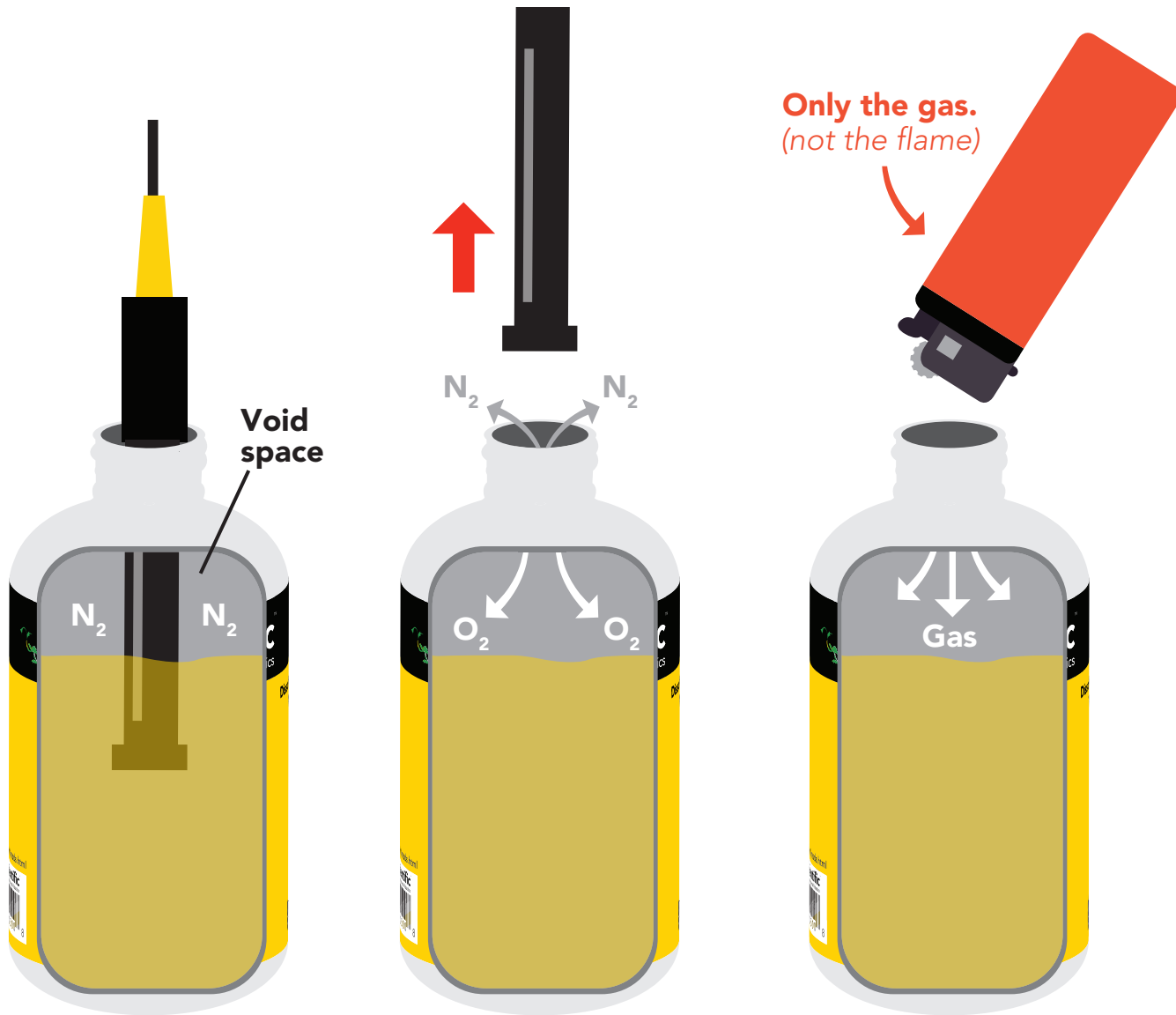

Inside each bottle of the calibration solution is a small amount of nitrogen gas that helps displace oxygen out of the bottle during the filling process. When the Dissolved Oxygen probe is removed from the bottle, oxygen will enter the bottle and begin to dissolve into the solution.

In order slow down this process, fill the void space of the bottle with any gas (*other than oxygen*) to preserve the calibration solution. Gas from a lighter works great if other gases are currently unobtainable.

Default state

UART mode

Baud	9,600
Readings	continuous
Speed	1 reading per second
Temperature compensation	20 °C
Salinity compensation	0 (Fresh water)
Pressure compensation	101.3 kPa (Sea level)
LED	on

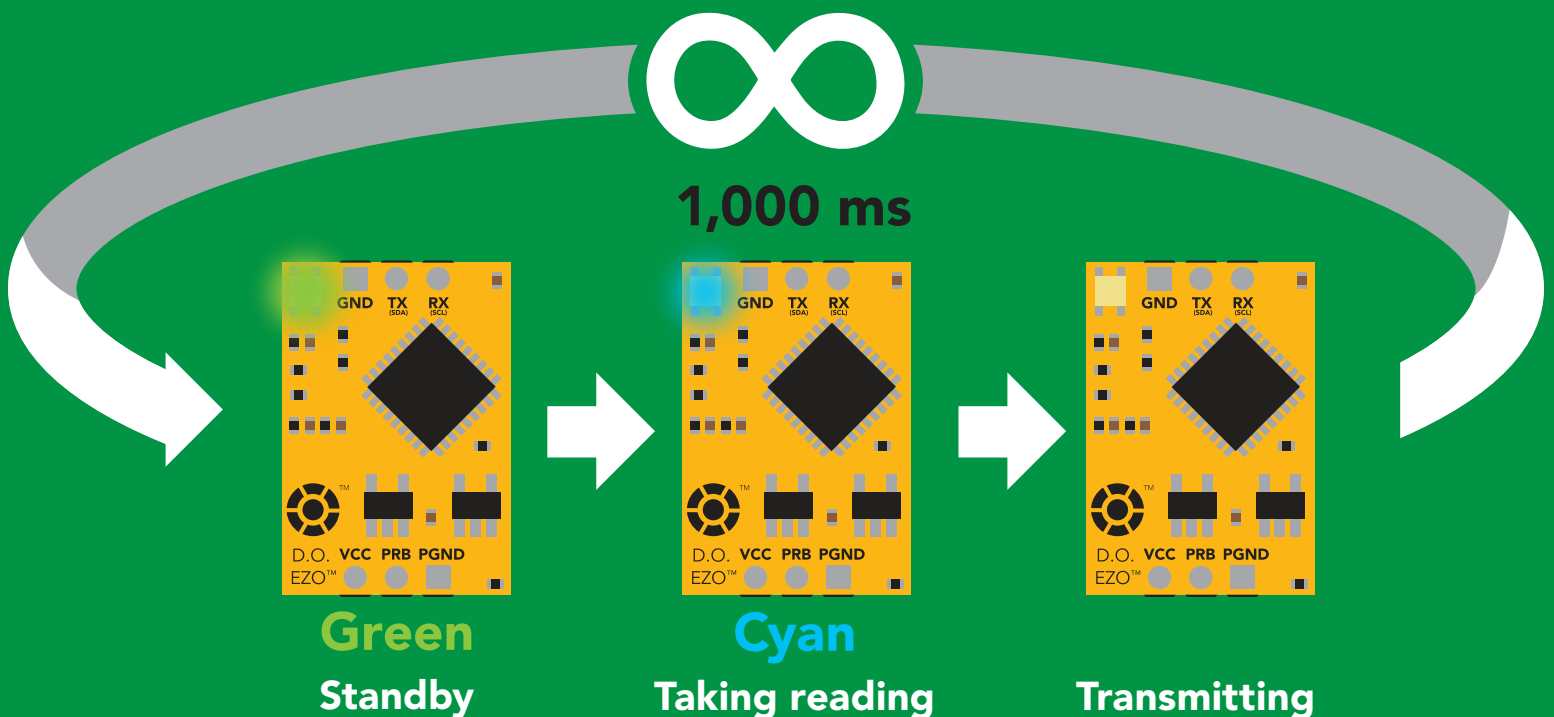

✓ Available data protocols

UART

Default

I²C

✗ Unavailable data protocols

SPI

Analog

RS-485

Mod Bus

4–20mA

UART mode

Settings that are retained if power is cut

- Baud rate
- Calibration
- Continuous mode
- Device name
- Enable/disable parameters
- Enable/disable response codes
- Hardware switch to I²C mode
- LED control
- Protocol lock
- Software switch to I²C mode

Settings that are **NOT** retained if power is cut

- Find
- Pressure compensation
- Salinity compensation
- Sleep mode
- Temperature compensation

UART mode

8 data bits no parity
1 stop bit no flow control

Baud 300
1,200
2,400
9,600 default
19,200
38,400
57,600
115,200

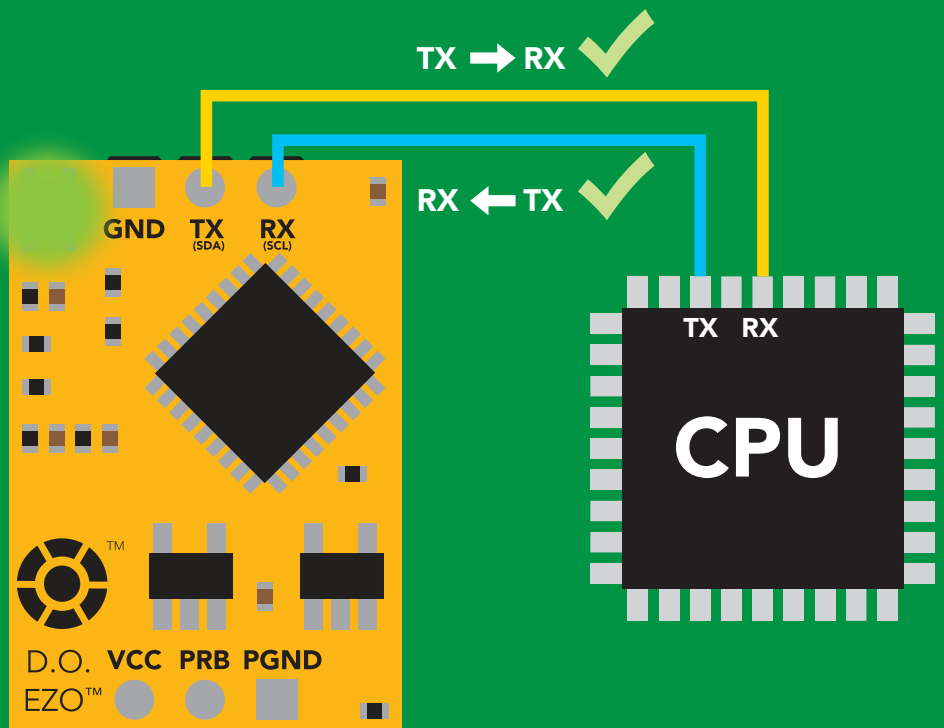
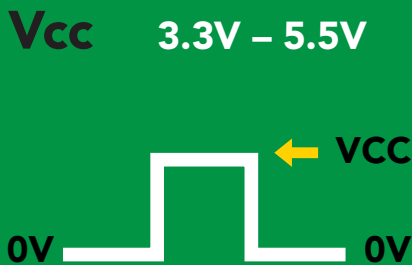

Data format

Reading	Dissolved Oxygen	Data type	floating point
Units	mg/L & (% sat) <small>when enabled</small>	Decimal places	mg/L = 2 % sat = 1
Encoding	ASCII	Smallest string	4 characters
Format	string <small>(CSV string when % sat is enabled)</small>	Largest string	16 characters
Terminator	carriage return		

Receiving data from device

2 parts

ASCII data string

Command

Carriage return <cr>

Terminator

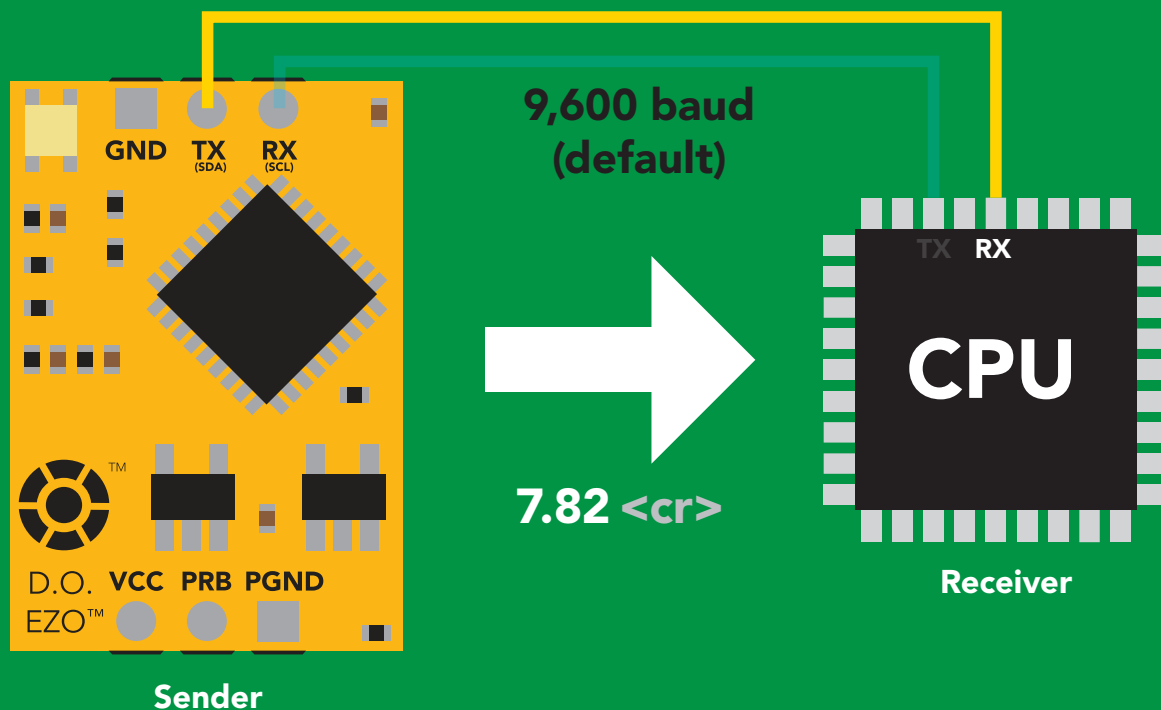

Advanced

ASCII: 7 . 8 2 <cr>

Hex: 37 2E 38 32 0D

Dec: 55 46 56 50 13

Sending commands to device

2 parts

Command (not case sensitive)

ASCII data string

Carriage return <cr>

Terminator

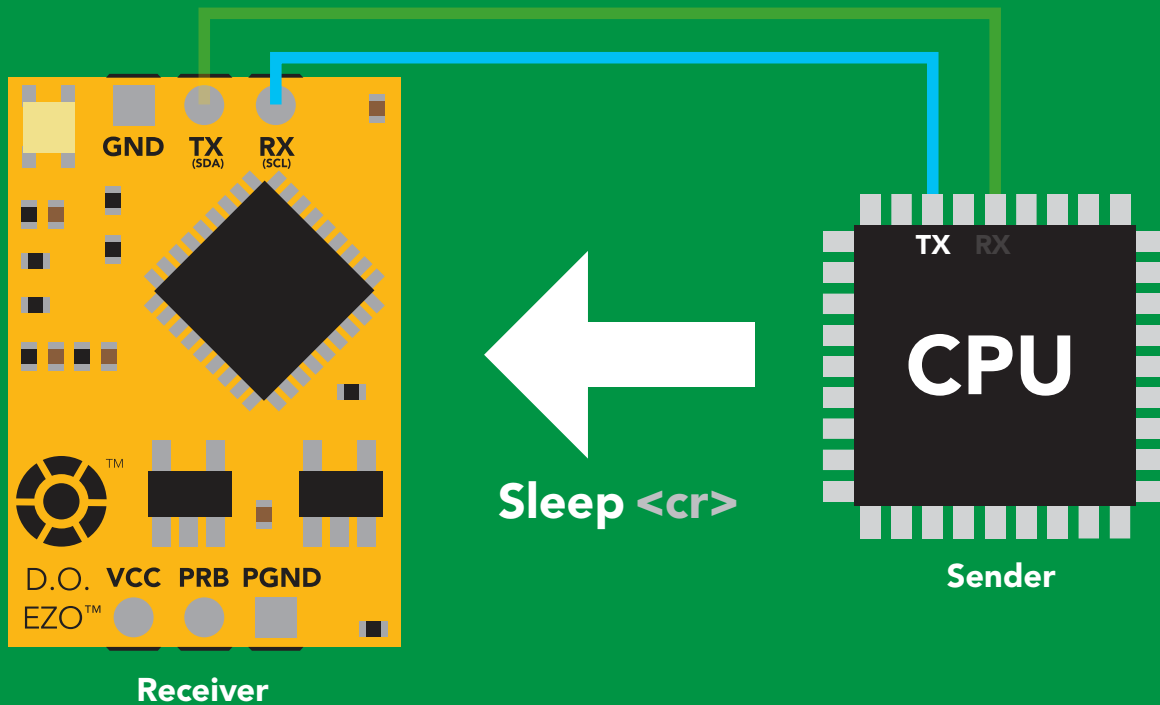

Advanced

ASCII: **S** **I** **e** **e** **p** **<cr>**

Hex: **53** **6C** **65** **65** **70** **0D**

Dec: **83** **108** **101** **101** **112** **13**

LED color definition

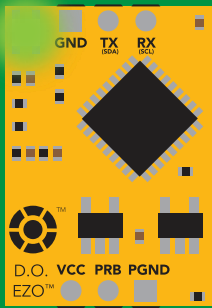

Green
UART standby

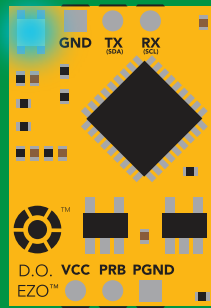

Cyan
Taking reading

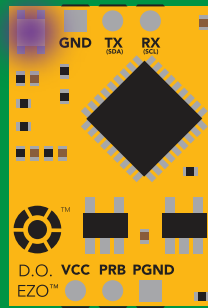

Purple
Changing baud rate

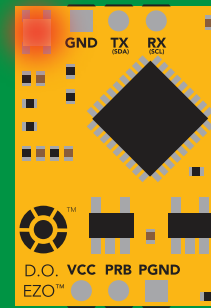

Red
Command not understood

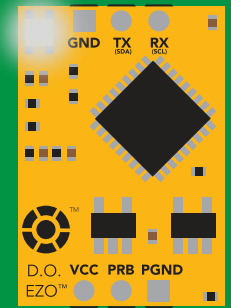

White
Find

5V

LED ON
+0.4 mA

3.3V

+0.2 mA

UART mode

command quick reference

All commands are ASCII strings or single ASCII characters.

Command	Function		Default state
Baud	change baud rate	pg. 37	9,600
C	enable/disable continuous reading	pg. 23	enabled
Cal	performs calibration	pg. 25	n/a
Export	export calibration	pg. 26	n/a
Factory	enable factory reset	pg. 39	n/a
Find	finds device with blinking white LED	pg. 22	n/a
i	device information	pg. 33	n/a
I2C	change to I ² C mode	pg. 40	not set
Import	import calibration	pg. 27	n/a
L	enable/disable LED	pg. 21	enabled
Name	set/show name of device	pg. 32	not set
O	enable/disable parameters	pg. 31	mg/L
P	pressure compensation	pg. 30	101.3 kPa
Plock	enable/disable protocol lock	pg. 38	disabled
R	returns a single reading	pg. 24	n/a
S	salinity compensation	pg. 29	n/a
Sleep	enter sleep mode/low power	pg. 36	n/a
Status	retrieve status information	pg. 35	n/a
T	temperature compensation	pg. 28	20°C
*OK	enable/disable response codes	pg. 34	enable

LED control

Command syntax

L,1 <cr> LED on **default**

L,0 <cr> LED off

L,? <cr> LED state on/off?

Example

Response

L,1 <cr>

*OK <cr>

L,0 <cr>

*OK <cr>

L,? <cr>

?L,1 <cr> or ?L,0 <cr>
*OK <cr>

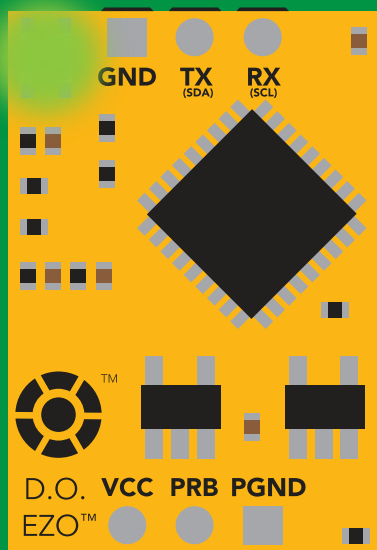

L,1

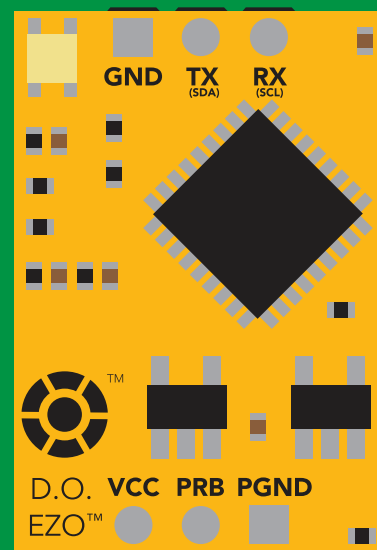

L,0

Find

Command syntax

This command will disable continuous mode
Send any character or command to terminate find.

Find <cr> LED rapidly blinks white, used to help find device

Example

Response

Find <cr>

*OK <cr>

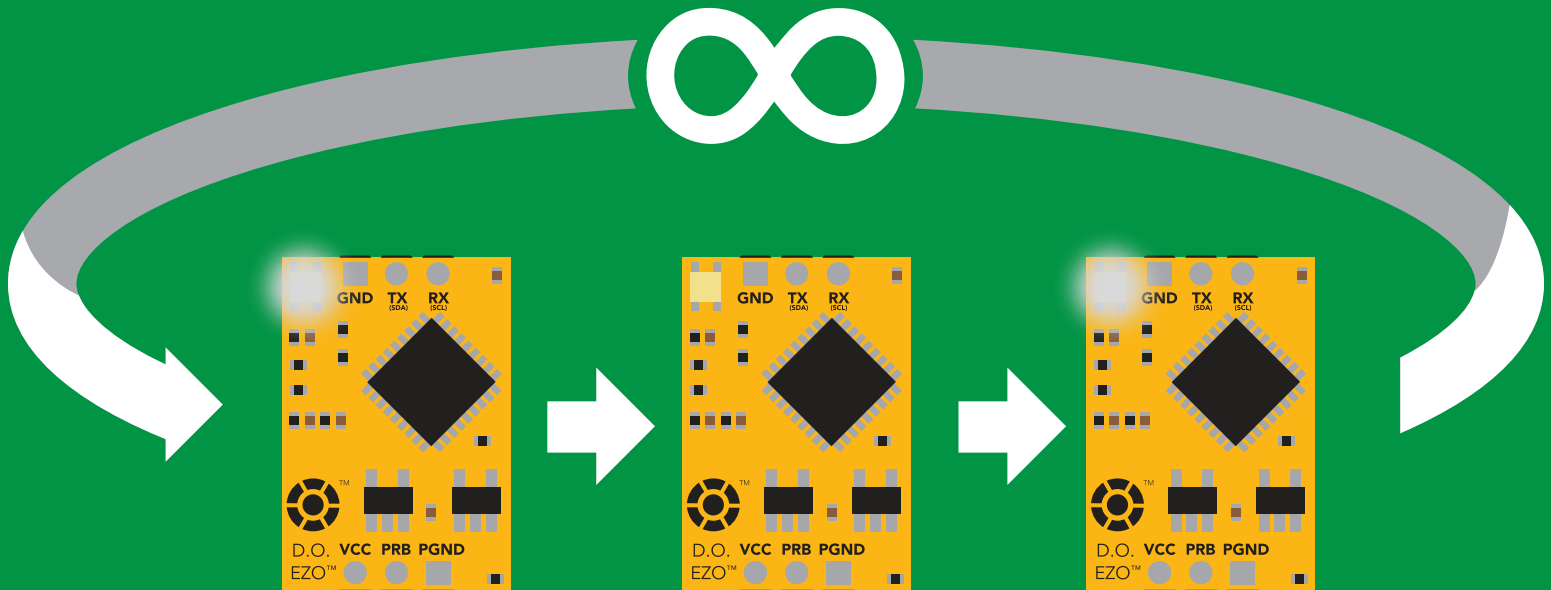

Continuous reading mode

Command syntax

- C,1 <cr>** enable continuous readings once per second **default**
- C,n <cr>** continuous readings every n seconds (n = 2 to 99 sec)
- C,0 <cr>** disable continuous readings
- C,? <cr>** continuous reading mode on/off?

Example

Response

C,1 <cr>

***OK <cr>**
DO (1 sec) <cr>
DO (2 sec) <cr>
DO (3 sec) <cr>

C,30 <cr>

***OK <cr>**
DO (30 sec) <cr>
DO (60 sec) <cr>
DO (90 sec) <cr>

C,0 <cr>

***OK <cr>**

C,? <cr>

?C,1 <cr> or ?C,0 <cr> or ?C,30 <cr>
***OK <cr>**

Single reading mode

Command syntax

R <cr> takes single reading

Example

R <cr>

Response

7.82 <cr>

*OK <cr>

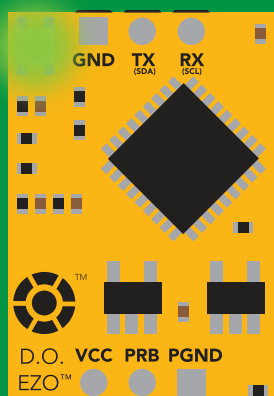

Green
Standby

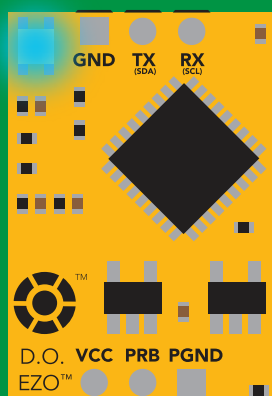

Cyan
Taking reading

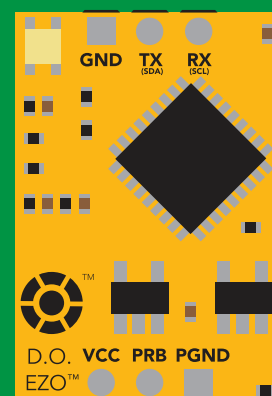
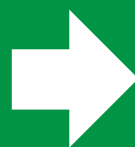

Yellow
Transmitting



600 ms

Calibration

Command syntax

The EZO™ Dissolved Oxygen circuit uses single and/or two point calibration

- Cal** <cr> calibrate to atmospheric oxygen levels
- Cal,0** <cr> calibrate device to 0 dissolved oxygen
- Cal,clear** <cr> delete calibration data
- Cal,?** <cr> device calibrated?

Example

Response

Cal <cr>

***OK** <cr>

Cal,0 <cr>

***OK** <cr>

Cal,clear <cr>

***OK** <cr>

Cal,? <cr>

?Cal,0 <cr> **or** **?Cal,1** <cr> **or** **?Cal,2** <cr>
*OK <cr> single point two point

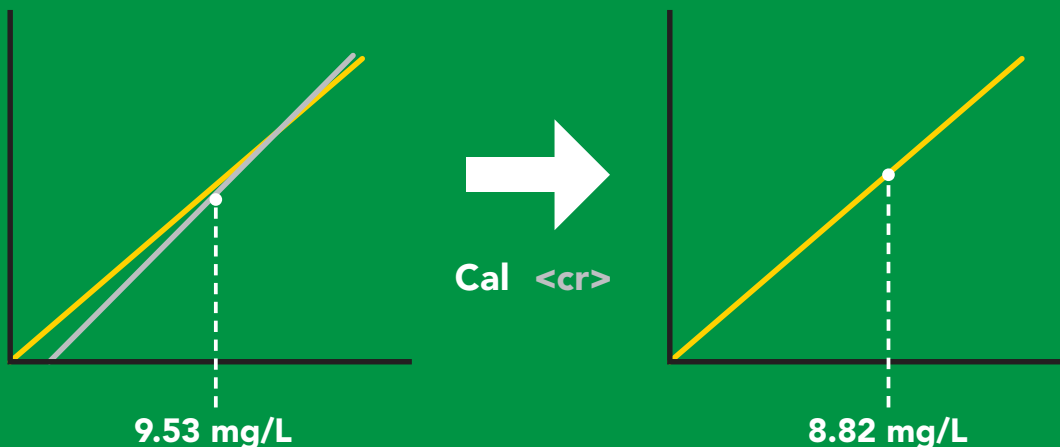

Export calibration

Command syntax

Export: Use this command to download calibration settings

Export,? <cr> calibration string info

Export <cr> export calibration string from calibrated device

Example

Response

Export,? <cr>

10,120 <cr>

Response breakdown

10, 120

of strings to export

of bytes to export

Export strings can be up to 12 characters long, and is always followed by <cr>

Export <cr>

59 6F 75 20 61 72 <cr> (1 of 10)

Export <cr>

65 20 61 20 63 6F <cr> (2 of 10)

(7 more)

⋮

Export <cr>

6F 6C 20 67 75 79 <cr> (10 of 10)

Export <cr>

***DONE**

Disabling *OK simplifies this process

Export <cr>

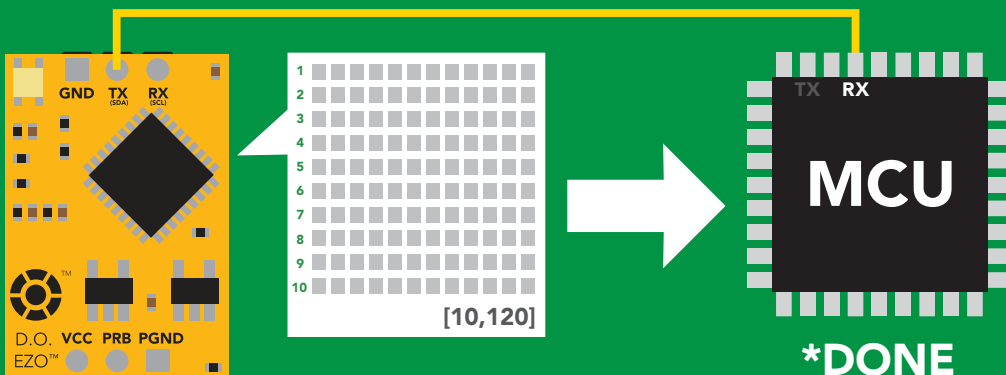

Import calibration

Command syntax

Import: Use this command to upload calibration settings to one or more devices.

Import,n <cr> import calibration string to new device

Example

Import, 59 6F 75 20 61 72 <cr> (1 of 10)

Import, 65 20 61 20 63 6F <cr> (2 of 10)

⋮

Import, 6F 6C 20 67 75 79 <cr> (10 of 10)

Response

*OK <cr>

*OK <cr>

⋮

*OK <cr>

Import,n <cr>

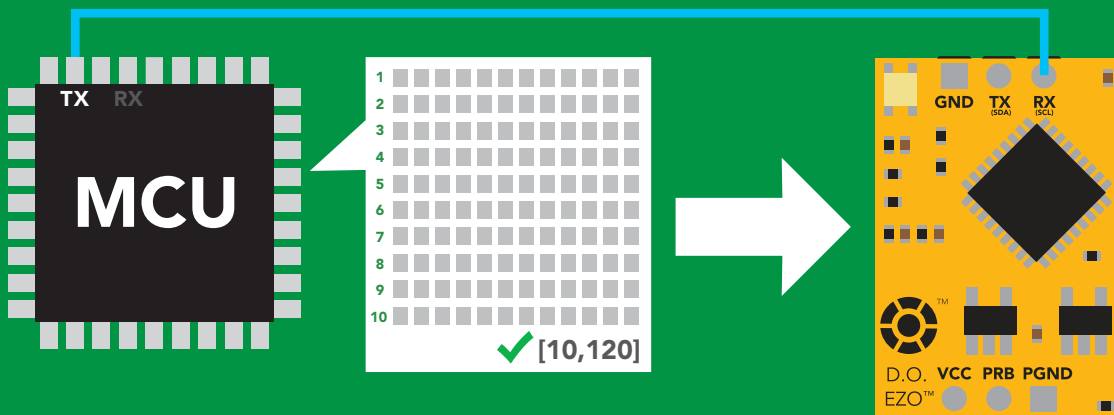

*OK <cr>

system will reboot

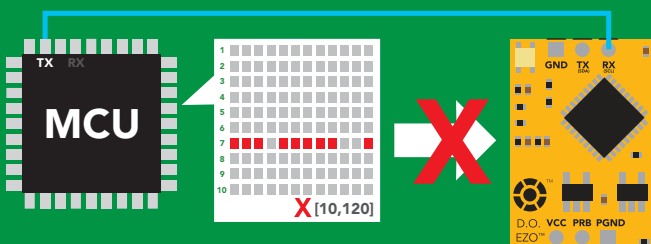

*ER <cr>

* If one of the imported strings is not correctly entered, the device will not accept the import, respond with *ER and reboot.

Temperature compensation

Command syntax

Default temperature = 20°C
Temperature is always in Celsius
Temperature is not retained if power is cut

T,n <cr> n = any value; floating point or int

T,? <cr> compensated temperature value?

RT,n <cr> set temperature compensation and take a reading*

This is a new command
for firmware V2.13

Example

Response

T,19.5 <cr>

***OK** <cr>

RT,19.5 <cr>

***OK** <cr>
8.91 <cr>

T,? <cr>

?T,19.5 <cr>
***OK** <cr>

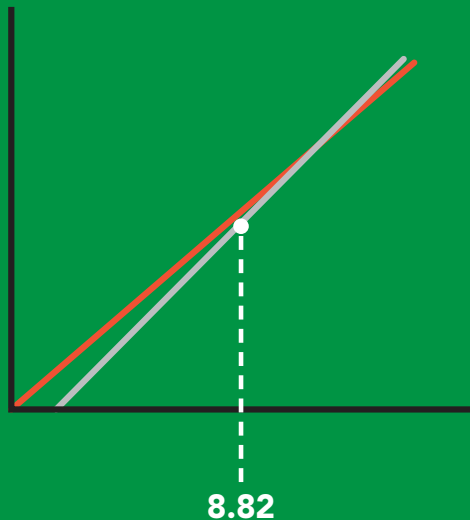

→
T,19.5 <cr>

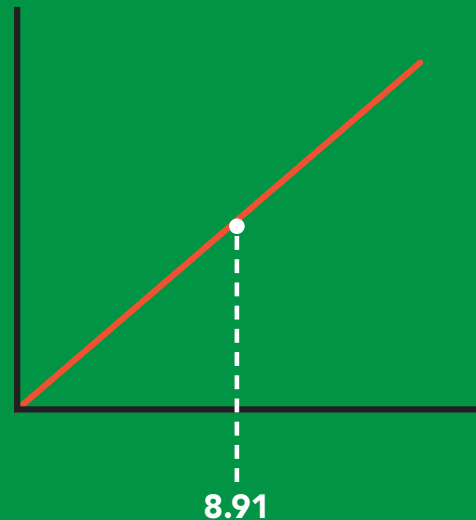

Salinity compensation

Command syntax

Default value = 0 μS
If the conductivity of your water is less than 2,500 μS this command is irrelevant

S,n <cr> n = any value in microsiemens
S,n,ppt <cr> n = any value in ppt
S,? <cr> compensated salinity value?

Example

Response

S,50000 <cr>

***OK** <cr>

S,37.5,ppt <cr>

***OK** <cr>

S,? <cr>

?S,50000, μS <cr> **or** **?S,37.5,ppt** <cr>
***OK** <cr>

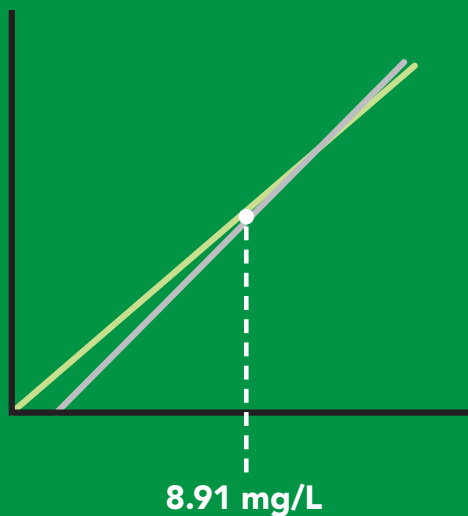

S,50000 <cr>

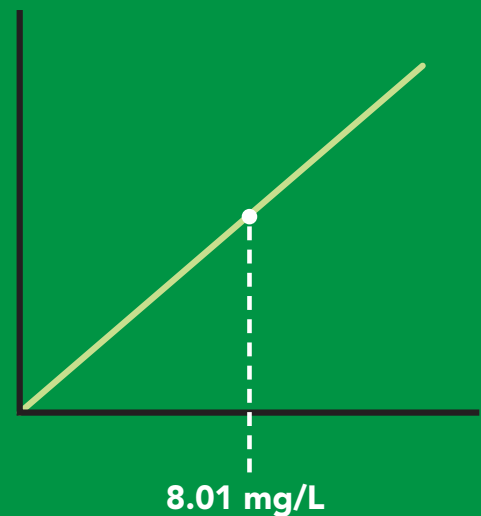

Pressure compensation

Command syntax

Default value = 101.3 kPa
This parameter can be omitted if the water is less than 10 meters deep

`P,n <cr>` n = any value in kPa

`P,? <cr>` compensated pressure value?

Example

Response

`P,90.25 <cr>`

`*OK <cr>`

`P,? <cr>`

`?,P,90.25 <cr>`
`*OK <cr>`

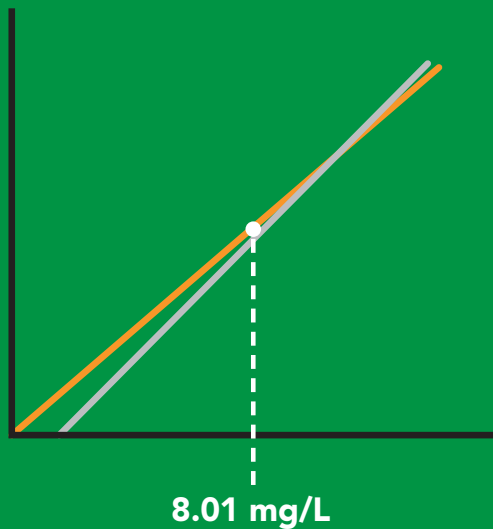

→
`P,90.25 <cr>`

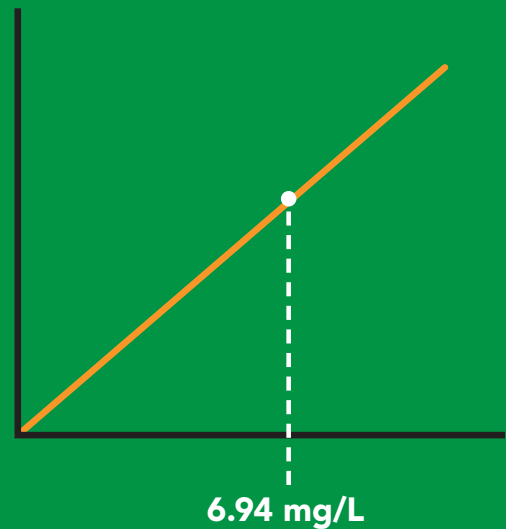

Enable/disable parameters from output string

Command syntax

O, [parameter],[1,0] <cr> enable or disable output parameter

O,? <cr> enabled parameter?

Example

O,mg,1 / O,mg,0 <cr>

O,%,1 / O,%,0 <cr>

O,? <cr>

Response

*OK <cr> enable / disable mg/L

*OK <cr> enable / disable percent saturation

?,O,%,mg <cr> if both are enabled

Parameters

mg mg/L
% percent saturation

Followed by 1 or 0

1 enabled
0 disabled

*** If you disable all possible data types your readings will display "no output".**

Naming device

Command syntax

Do not use spaces in the name

Name,n <cr> set name

Name,? <cr> show name

n =

1 2 3 4 5 6 7 8 9 10 11 12 13 14 15 16

Up to 16 ASCII characters

Example

Response

Name,zzt <cr>

*OK <cr>

Name,? <cr>

?Name,zzt <cr>
*OK <cr>

Name,zzt

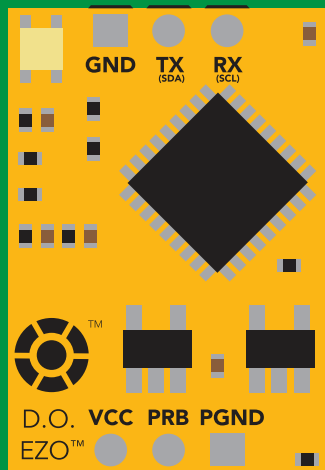

*OK <cr>

Name,?

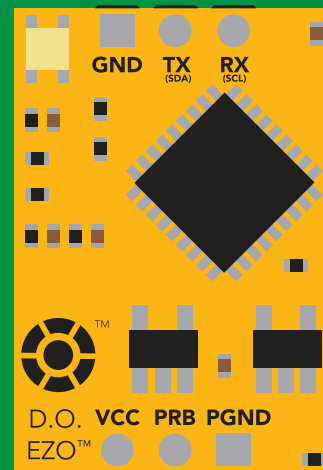

Name,zzt <cr>
*OK <cr>

Device information

Command syntax

```
i <cr> device information
```

Example

```
i <cr>
```

Response

```
?i,D.O.,1.98 <cr>  
*OK <cr>
```

Response breakdown

```
?i, D.O., 1.98  
    ↑      ↑  
  Device Firmware
```

Response codes

Command syntax

- *OK,1** <cr> enable response **default**
- *OK,0** <cr> disable response
- *OK,?** <cr> response on/off?

Example

Response

R <cr>

7.82 <cr>
***OK** <cr>

***OK,0** <cr>

no response, ***OK** disabled

R <cr>

7.82 <cr> ***OK** disabled

***OK,?** <cr>

?*OK,1 <cr> or **?*OK,0** <cr>

Other response codes

- *ER** unknown command
- *OV** over volt ($VCC \geq 5.5V$)
- *UV** under volt ($VCC \leq 3.1V$)
- *RS** reset
- *RE** boot up complete, ready
- *SL** entering sleep mode
- *WA** wake up

These response codes
cannot be disabled

Reading device status

Command syntax

Status <cr> voltage at Vcc pin and reason for last restart

Example

```
Status <cr>
```

Response

```
?Status,P,5.038 <cr>  
*OK <cr>
```

Response breakdown

?Status,	P,	5.038
	↑	↑
	Reason for restart	Voltage at Vcc

Restart codes

P	powered off
S	software reset
B	brown out
W	watchdog
U	unknown

Sleep mode/low power

Command syntax

Send any character or command to awaken device.

Sleep <cr> enter sleep mode/low power

Example

Response

Sleep <cr>

*OK <cr>

*SL <cr>

Any command

*WA <cr> wakes up device

5V

STANDBY

13.1 mA

SLEEP

0.66 mA

3.3V

12 mA

0.3 mA

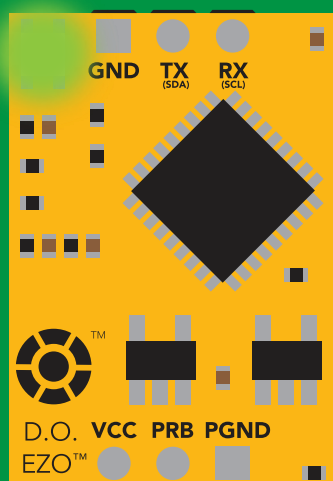

Standby
13.1 mA

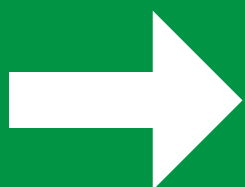

Sleep <cr>

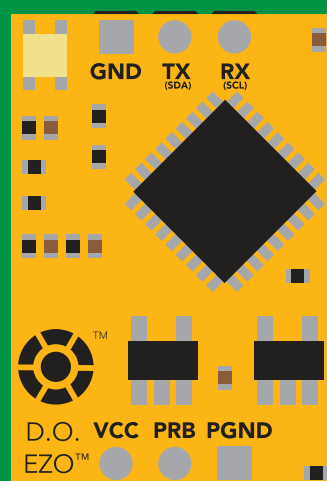

Sleep
0.66 mA

Change baud rate

Command syntax

Baud,n <cr> change baud rate

Example

Baud,38400 <cr>

*OK <cr>

Baud,? <cr>

?Baud,38400 <cr>

*OK <cr>

n =

- 300
- 1200
- 2400
- 9600 default**
- 19200
- 38400
- 57600
- 115200

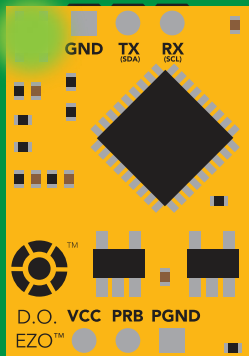

Standby

Baud,38400 <cr>

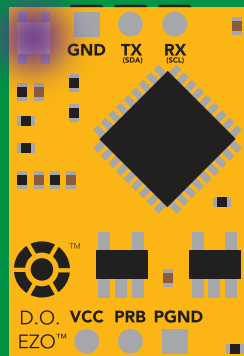

Changing
baud rate

*OK <cr>

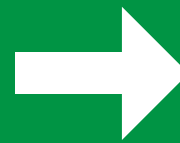

(reboot)

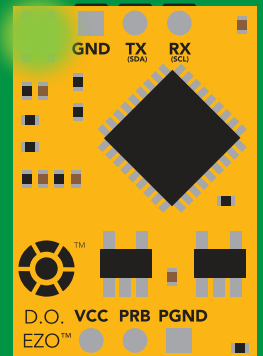

Standby

Protocol lock

Command syntax

Locks device to UART mode.

Plock,1 <cr> enable Plock

Plock,0 <cr> disable Plock **default**

Plock,? <cr> Plock on/off?

Example

Response

Plock,1 <cr>

*OK <cr>

Plock,0 <cr>

*OK <cr>

Plock,? <cr>

?Plock,1 <cr> **or** ?Plock,0 <cr>

Plock,1

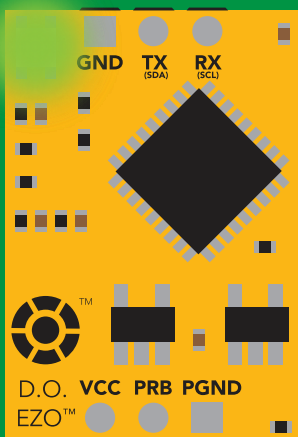

*OK <cr>

I2C,100

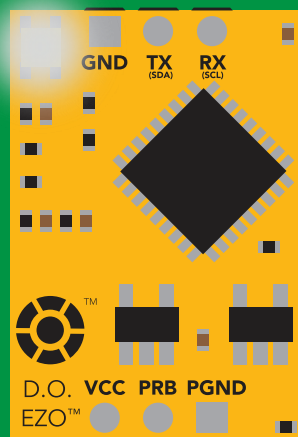

cannot change to I²C

*ER <cr>

Short

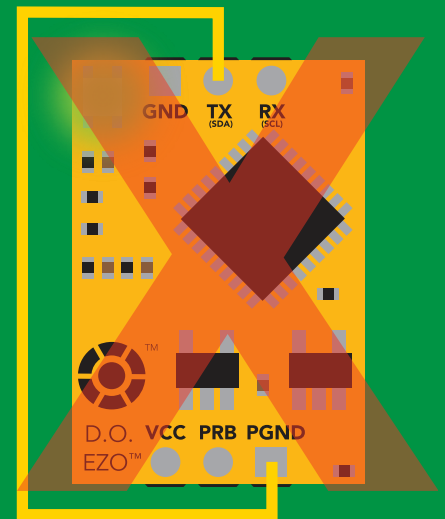

cannot change to I²C

Factory reset

Command syntax

Clears calibration
LED on
"*OK" enabled

Factory <cr> enable factory reset

Example

Response

Factory <cr>

*OK <cr>

Factory <cr>

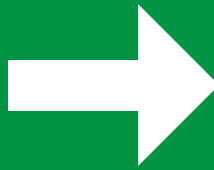
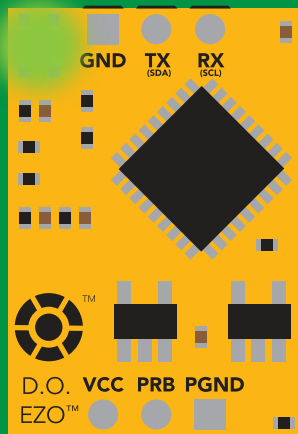

(reboot)

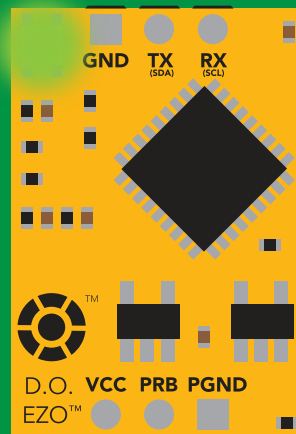

*OK <cr>

*RS <cr>

*RE <cr>

Baud rate will not change

Change to I²C mode

Command syntax

Default I²C address 97 (0x61)

I2C,n <cr> sets I²C address and reboots into I²C mode

n = any number 1 – 127

Example

Response

I2C,100 <cr>

*OK (reboot in I²C mode)

Wrong example

Response

I2C,139 <cr> n ≠ 127

*ER <cr>

I2C,100

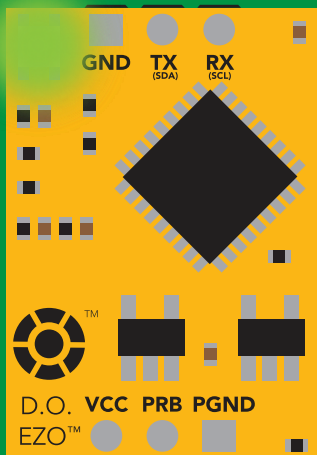

Green
*OK <cr>

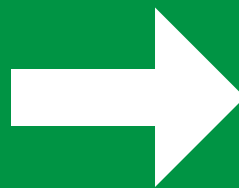

(reboot)

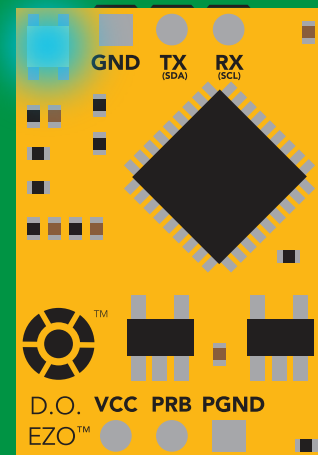

Blue
now in I²C mode

Manual switching to I²C

- Disconnect ground (power off)
- Disconnect TX and RX
- Connect TX to PGND
- Confirm RX is disconnected
- Connect ground (power on)
- Wait for LED to change from **Green** to **Blue**
- Disconnect ground (power off)
- Reconnect all data and power

Manually switching to I²C will set the I²C address to 97 (0x61)

Example

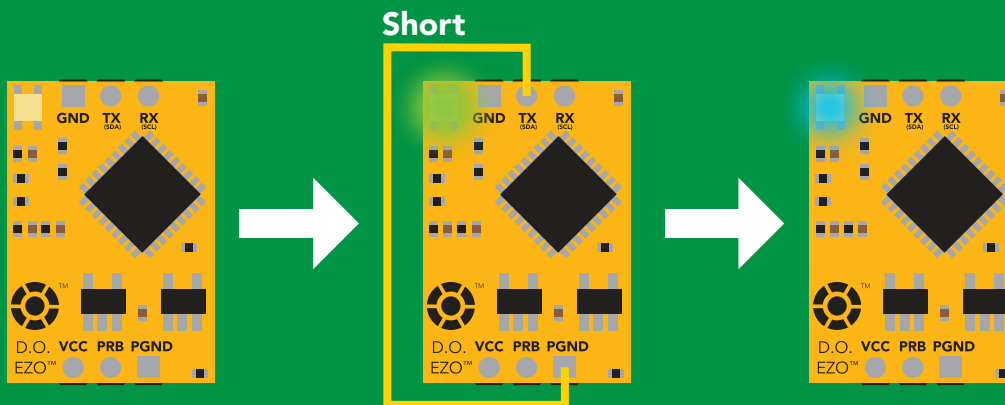

Wrong Example

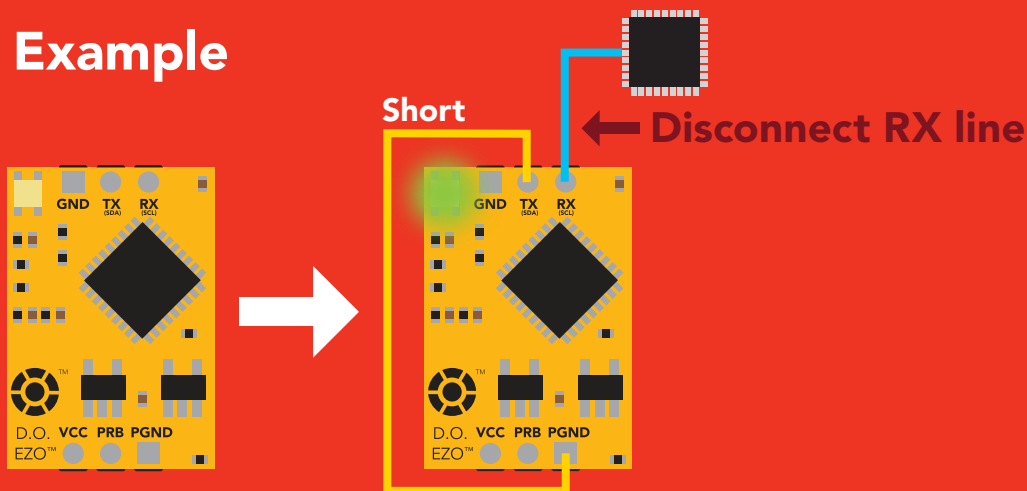

I²C mode

The I²C protocol is **considerably more complex** than the UART (RS-232) protocol. Atlas Scientific assumes the embedded systems engineer understands this protocol.

To set your EZO™ device into I²C mode click [here](#)

Settings that are retained if power is cut

- Calibration
- Change I²C address
- Enable/disable parameters
- Hardware switch to UART mode
- LED control
- Protocol lock
- Software switch to UART mode

Settings that are **NOT** retained if power is cut

- Find
- Pressure compensation
- Salinity compensation
- Sleep mode
- Temperature compensation

I²C mode

I²C address (0x01 – 0x7F)
97 (0x61) default

V_{cc} 3.3V – 5.5V

Clock speed 100 – 400 kHz

SDA 

SCL 



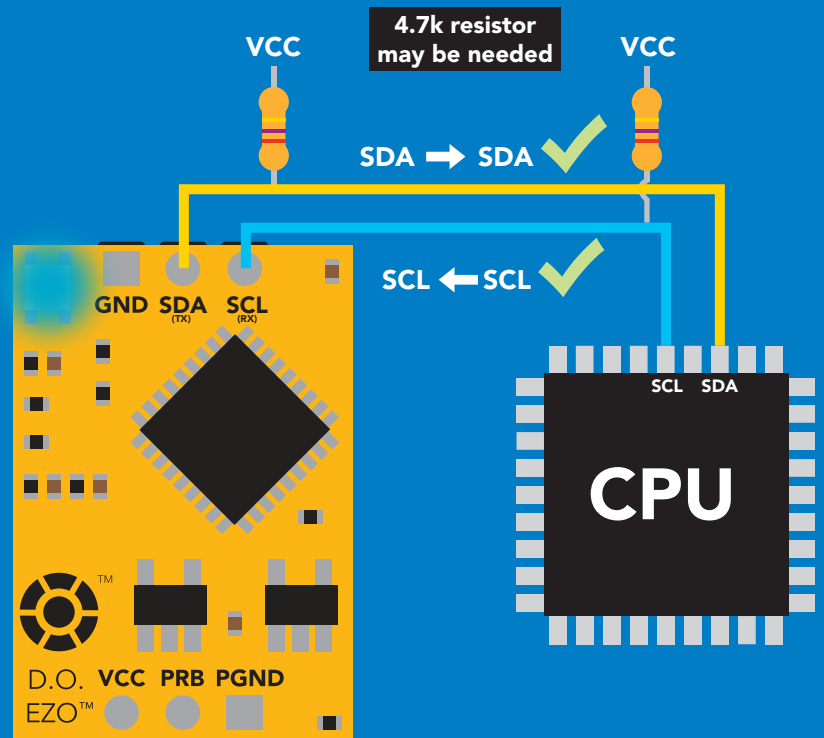

Data format

Reading	Dissolved Oxygen	Data type	floating point
Units	mg/L & (% sat) <small>when enabled</small>	Decimal places	mg/L = 2 % sat = 1
Encoding	ASCII	Smallest string	4 characters
Format	string <small>(CSV string when % sat is enabled)</small>	Largest string	16 characters

Sending commands to device

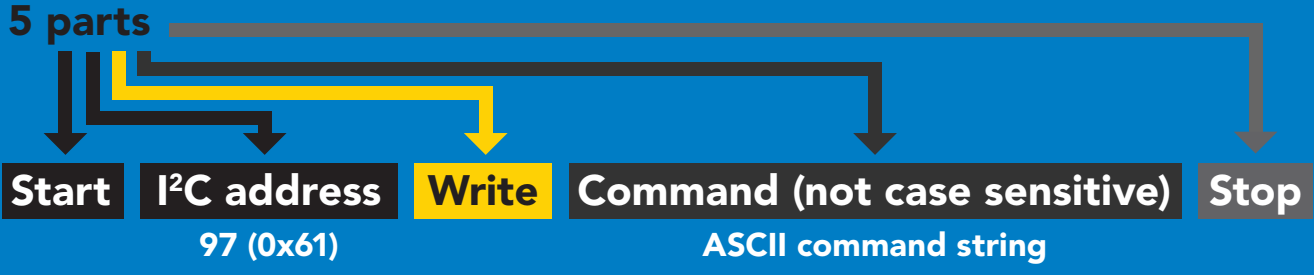

Example

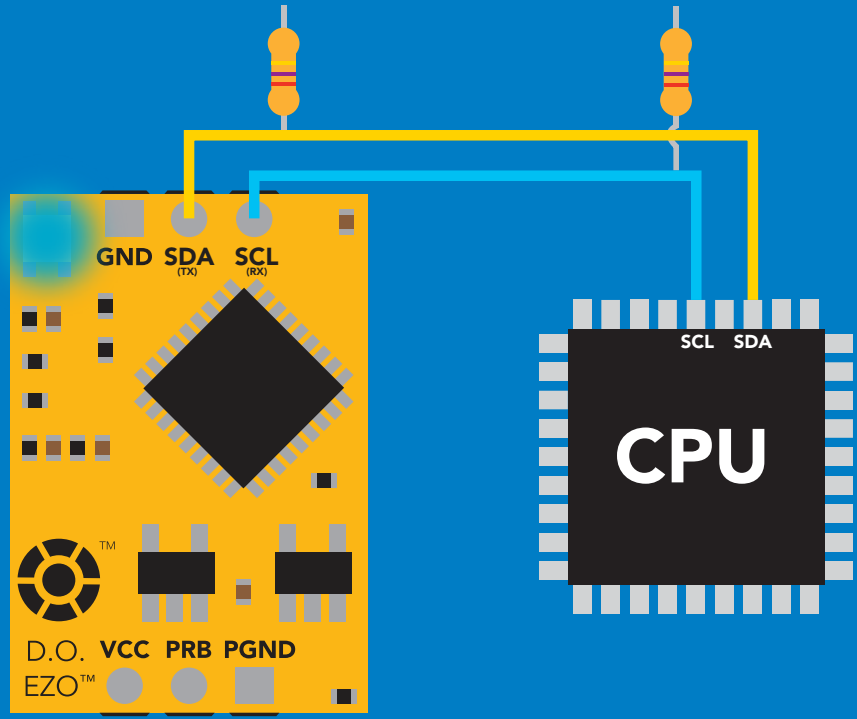

Advanced

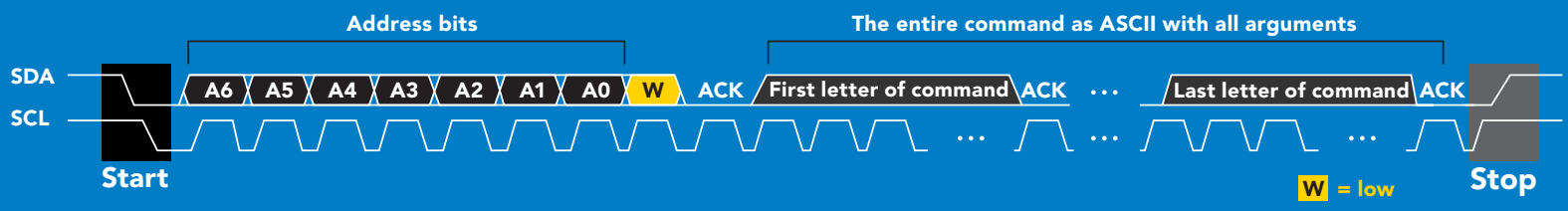

Requesting data from device

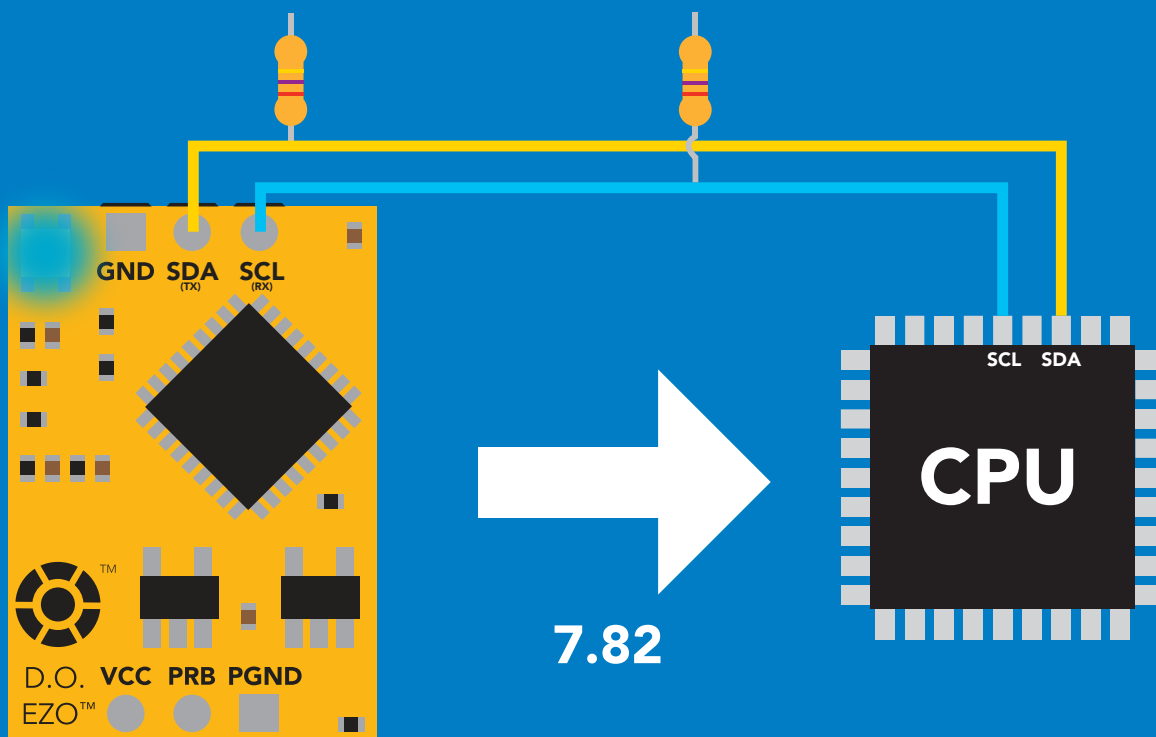
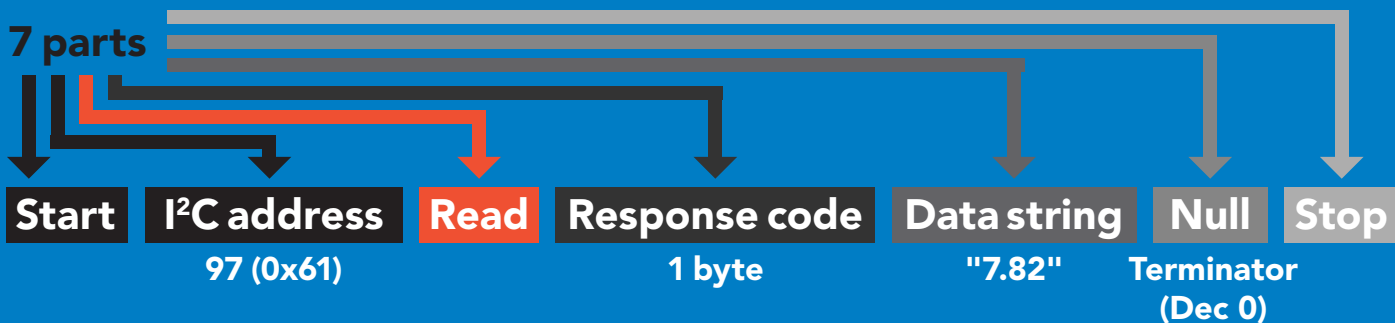

Advanced

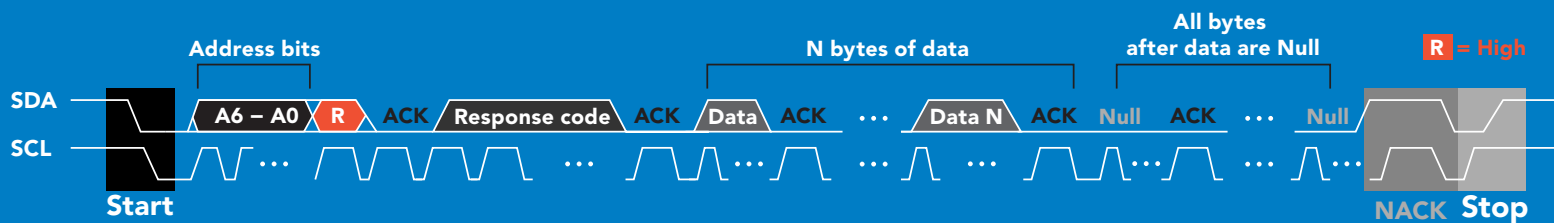

Response codes

After a command has been issued, a 1 byte response code can be read in order to confirm that the command was processed successfully.

Reading back the response code is completely optional, and is not required for normal operation.

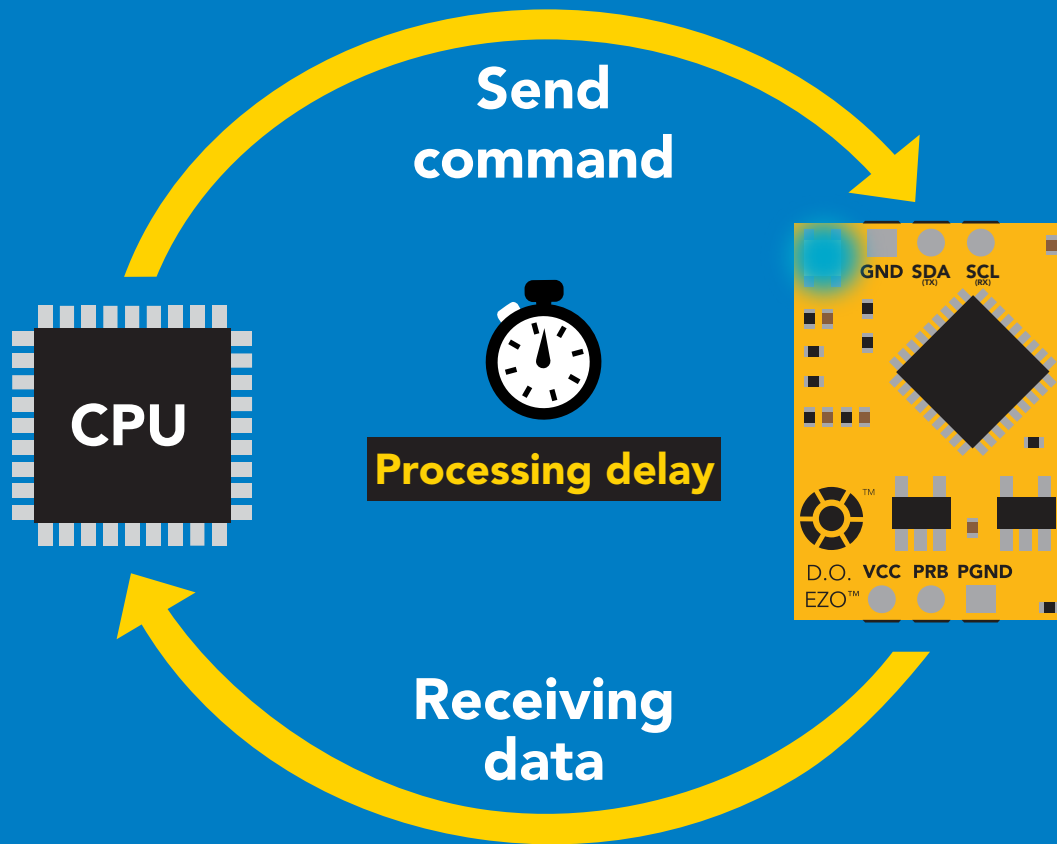

Example

```
I2C_start;  
I2C_address;  
I2C_write(EZO_command);  
I2C_stop;
```

`delay(300);`



Processing delay

```
I2C_start;  
I2C_address;  
Char[ ] = I2C_read;  
I2C_stop;
```

The response code will always be 254, if you do not wait for the processing delay.

Response codes

Single byte, not string

255	no data to send
254	still processing, not ready
2	syntax error
1	successful request

LED color definition

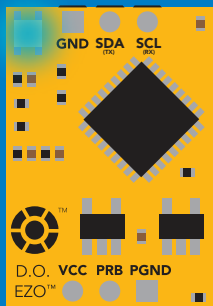

Blue

I²C standby

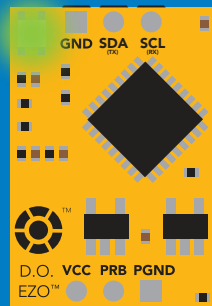

Green

Taking reading

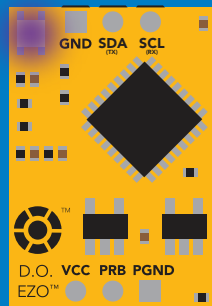

Purple

Changing
I²C address

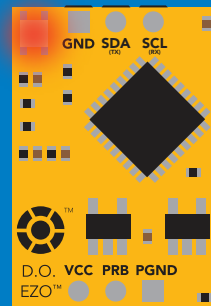

Red

Command
not understood

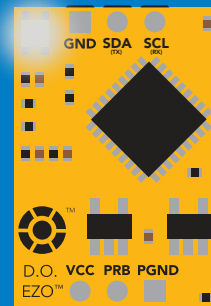

White

Find

5V

LED ON

+0.4 mA

3.3V

+0.2 mA

I²C mode

command quick reference

All commands are ASCII strings or single ASCII characters.

Command	Function	
Baud	change back to UART mode	pg. 66
Cal	performs calibration	pg. 52
Export	export calibration	pg. 53
Factory	enable factory reset	pg. 65
Find	finds device with blinking white LED	pg. 50
i	device information	pg. 60
I2C	change I ² C address	pg. 64
Import	import calibration	pg. 54
L	enable/disable LED	pg. 49
Name	set/show name of device	pg. 59
O	removing parameters	pg. 58
P	pressure compensation	pg. 57
Plock	enable/disable protocol lock	pg. 63
R	returns a single reading	pg. 51
S	salinity compensation	pg. 56
Sleep	enter sleep mode/low power	pg. 62
Status	retrieve status information	pg. 61
T	temperature compensation	pg. 55

LED control

Command syntax

300ms  processing delay

- L,1 LED on **default**
- L,0 LED off
- L,? LED state on/off?

Example

Response

L,1

 **Wait 300ms** **1** **0**
Dec Null

L,0

 **Wait 300ms** **1** **0**
Dec Null

L,?

 **Wait 300ms** **1** **?L,1** **0** or **1** **?L,0** **0**
Dec ASCII Null Dec ASCII Null

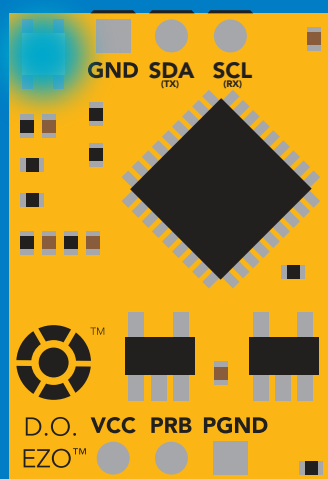

L,1

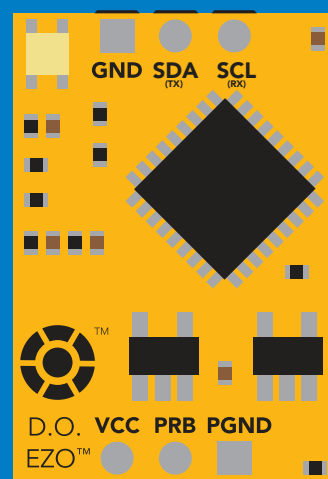

L,0

Find

300ms  processing delay

Command syntax

This command will disable continuous mode
Send any character or command to terminate find.

Find LED rapidly blinks white, used to help find device

Example

Response

Find

 Wait 300ms
1 Dec 0 Null

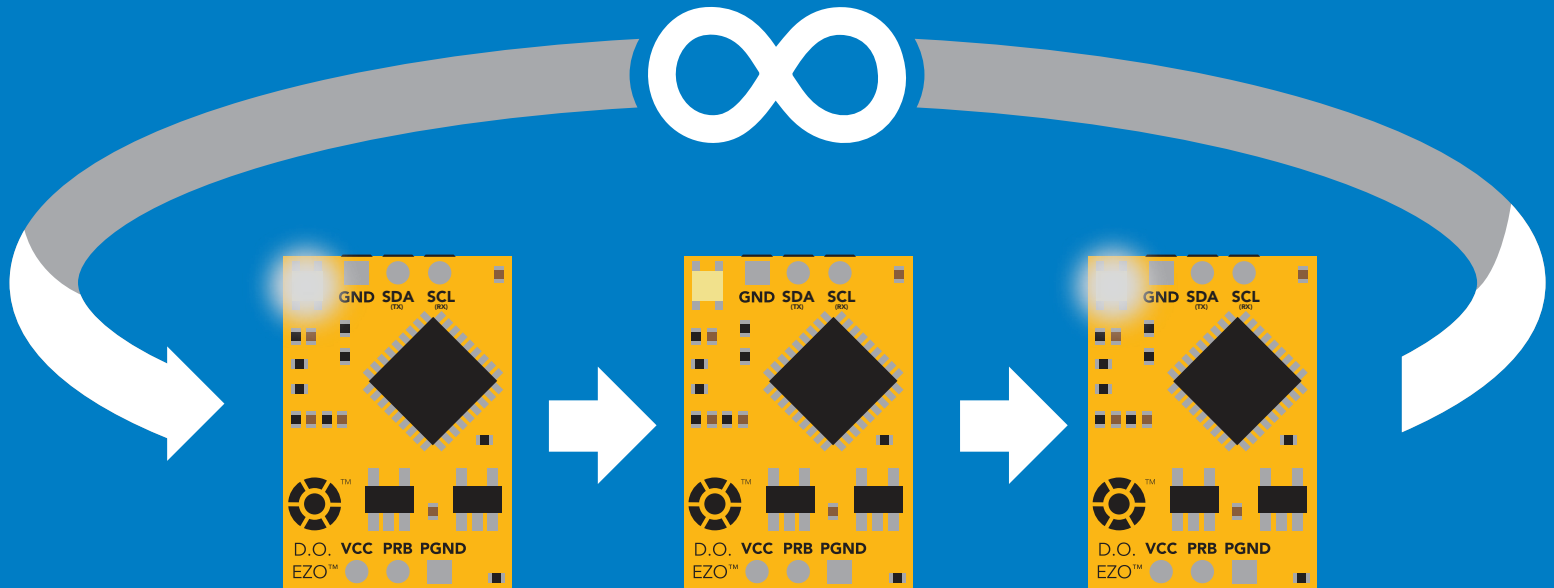

Taking reading

Command syntax

600ms  processing delay

R return 1 reading

Example

Response

R

 Wait 600ms **1** Dec **7.82** ASCII **0** Null

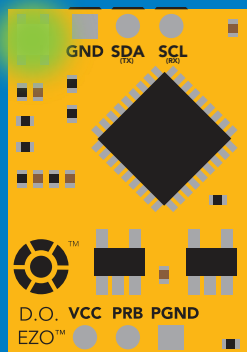

Green

Taking reading

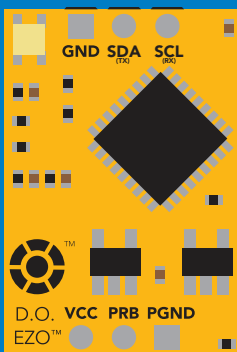
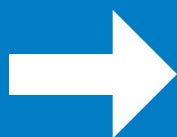

Transmitting

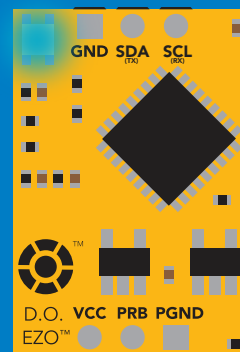
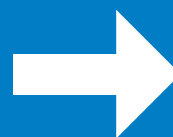

Blue

Standby

Calibration

Command syntax

1300ms  processing delay

- Cal calibrate to atmospheric oxygen levels
- Cal,0 calibrate device to 0 dissolved oxygen
- Cal,clear delete calibration data
- Cal,? device calibrated?

The EZO™ Dissolved Oxygen circuit uses single and/or two point calibration

Example

Response

Cal

Wait 1300ms 1 0
Dec Null

Cal,0

Wait 1300ms 1 0
Dec Null

Cal,clear

Wait 300ms 1 0
Dec Null

Cal,?

Wait 300ms 1 ?Cal,0 0 or 1 ?Cal,1 0
Dec ASCII Null Dec ASCII Null

or 1 ?Cal,2 0
Dec ASCII Null

Export calibration

300ms  processing delay

Command syntax

Export: Use this command to download calibration settings

Export,? calibration string info

Export export calibration string from calibrated device

Example

Response

Export,?



Wait 300ms

1

Dec

10,120

ASCII

0

Null

Response breakdown

10, 120

of strings to export # of bytes to export

Export strings can be up to 12 characters long

Export



Wait 300ms

1

Dec

59 6F 75 20 61 72

ASCII

0

Null

(1 of 10)

Export



Wait 300ms

1

Dec

65 20 61 20 63 6F

ASCII

0

Null

(2 of 10)

(7 more)

⋮

Export



Wait 300ms

1

Dec

6F 6C 20 67 75 79

ASCII

0

Null

(10 of 10)

Export



Wait 300ms

1

Dec

*DONE

ASCII

0

Null

Import calibration

300ms  processing delay

Command syntax

Import: Use this command to upload calibration settings to one or more devices.

Import,n import calibration string to new device

Example

Import, 59 6F 75 20 61 72 (1 of 10)

Import, 65 20 61 20 63 6F (2 of 10)

⋮

Import, 6F 6C 20 67 75 79 (10 of 10)

Response

 Wait 300ms **1** **0**
Dec Null

 Wait 300ms **1** **0**
Dec Null

⋮

 Wait 300ms **1** **0**
Dec Null

Import,n

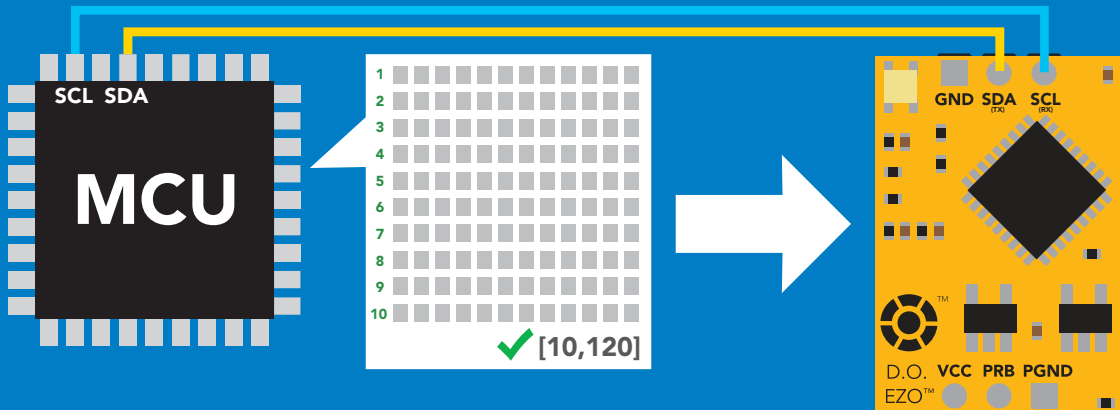

1 ***Pending** **0**
Dec ASCII Null

system will reboot

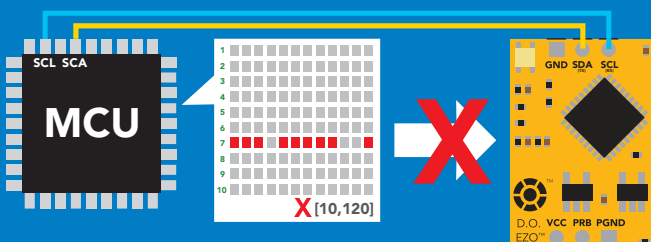

reboot

* If one of the imported strings is not correctly entered, the device will not accept the import and reboot.

Temperature compensation

Command syntax

Default temperature = 20°C
Temperature is always in Celsius
Temperature is not retained if power is cut

T,n n = any value; floating point or int 300ms  processing delay

T,? compensated temperature value?

RT,n set temperature compensation and take a reading*

This is a new command for firmware V2.13

Example

Response

T,19.5

 Wait 300ms **1** **0**
Dec Null

RT,19.5

 Wait 900ms **1** **8.91** **0**
Dec ASCII Null

T,?

 Wait 300ms **1** **?T,19.5** **0**
Dec ASCII Null

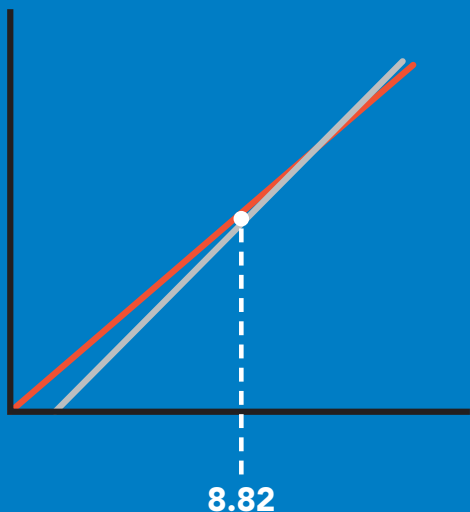

T,19.5

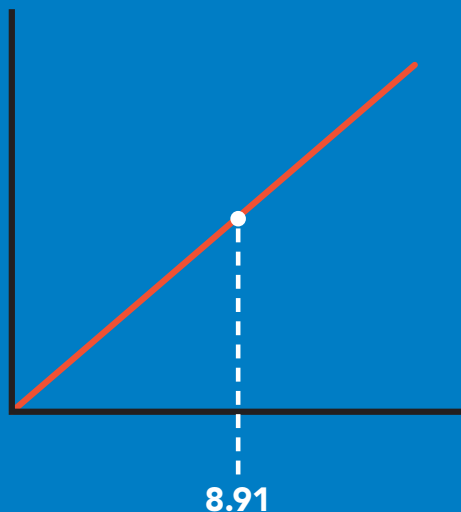

Salinity compensation

Command syntax

300ms  processing delay

S,n n = any value in microsiemens

default

S,n,ppt n = any value in ppt

S,? compensated salinity value?

Example

Response

S,50000



Wait 300ms

1

Dec

0

Null

S,37.5,ppt



Wait 300ms

1

Dec

0

Null

S,?



Wait 300ms

1

Dec

?S,50000,μS

ASCII

0

Null

or

1

Dec

?S,37.5,ppt

ASCII

0

Null

If the conductivity of your water is less than 2,500μS this command is irrelevant

Pressure compensation

Command syntax

300ms  processing delay

P,n n = any value in kPa

P,? compensated pressure value?

This parameter can be omitted if the water is less than 10 meters deep

Example

P,90.25



1
Dec

0
Null



1
Dec

?,P,90.25
ASCII

0
Null

P,?

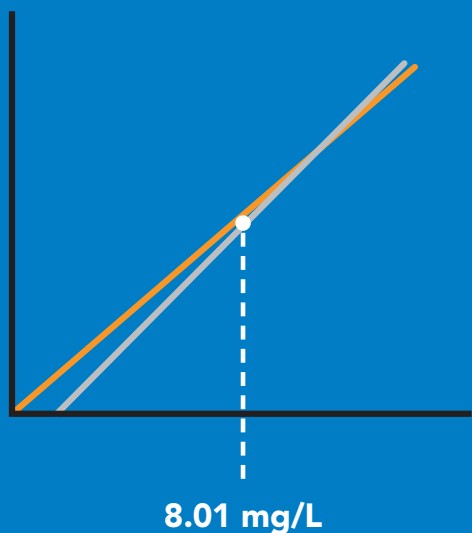

P,90.25

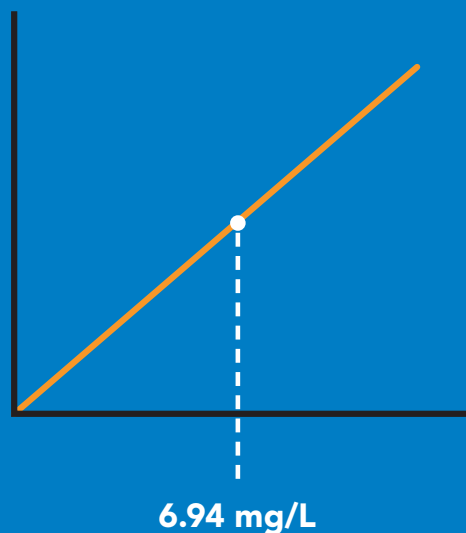

Enable/disable parameters from output string

Command syntax

300ms  processing delay

O, [parameter],[1,0]

enable or disable output parameter

O,?

enabled parameter?

Example

Response

O,mg,1 / O,mg,0



1 **0**
Dec Null

enable / disable mg/L

O,%,1 / O,%,0



1 **0**
Dec Null

enable / disable percent saturation

O,?



1 **? , O , % , mg** **0**
Dec ASCII Null

if both are enabled

Parameters

mg mg/L
% percent saturation

Followed by 1 or 0

1 enabled
0 disabled

* If you disable all possible data types your readings will display "no output".

Naming device

300ms  processing delay

Command syntax

Do not use spaces in the name

Name,n set name n =

1	2	3	4	5	6	7	8	9	10	11	12	13	14	15	16
---	---	---	---	---	---	---	---	---	----	----	----	----	----	----	----

Name,? show name Up to 16 ASCII characters

Example

Response

Name,zzt

 Wait 300ms

1	0
---	---

Dec Null

Name,?

 Wait 300ms

1	?Name,zzt	0
---	-----------	---

Dec ASCII Null

Name,zzt

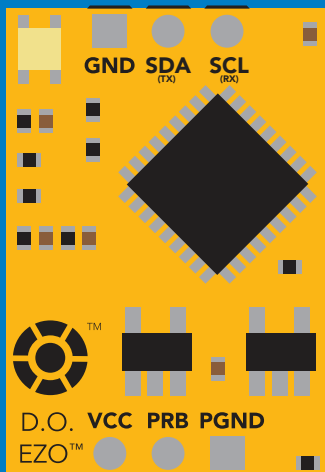

Name,?

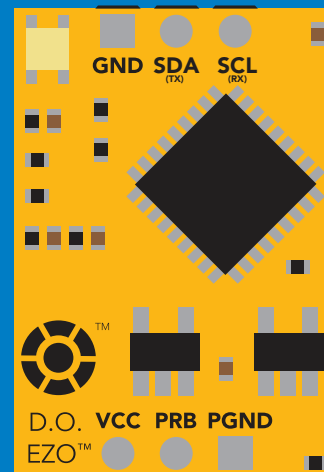

1	0
---	---

1	?Name,zzt	0
---	-----------	---

Device information

Command syntax

300ms  processing delay

i device information

Example

Response

i



Wait 300ms

1

Dec

?i,D.O.,1.98

ASCII

0

Null

Response breakdown

?i,	D.O.,	1.98
	↑	↑
	Device	Firmware

Reading device status

Command syntax

300ms  processing delay

Status voltage at Vcc pin and reason for last restart

Example

Response

Status

 **1** **?Status,P,5.038** **0**
Wait 300ms Dec ASCII Null

Response breakdown

?Status, **P,** **5.038**
Reason for restart Voltage at Vcc

Restart codes

- P powered off
- S software reset
- B brown out
- W watchdog
- U unknown

Sleep mode/low power

Command syntax

Sleep enter sleep mode/low power

Send any character or command to awaken device.

Example

Response

Sleep

no response

Do not read status byte after issuing sleep command.

Any command

wakes up device

5V

STANDBY

13.1 mA

SLEEP

0.66 mA

3.3V

12 mA

0.3 mA

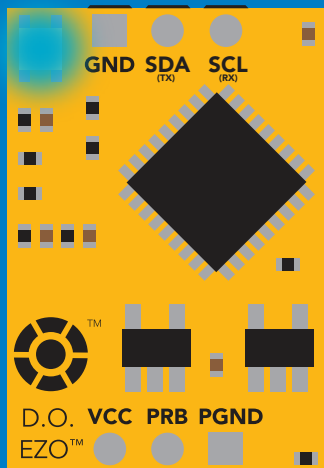

Standby

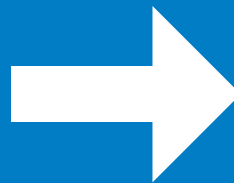

Sleep

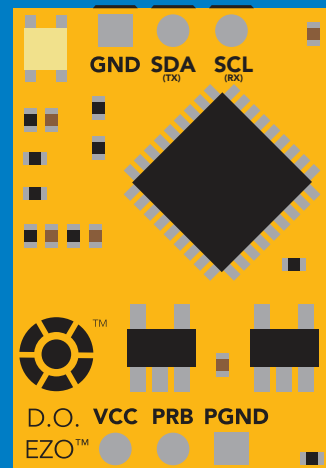

Sleep

Protocol lock

Command syntax

300ms  processing delay

Plock,1 enable Plock

Plock,0 disable Plock

Plock,? Plock on/off?

default

Locks device to I²C mode.

Example

Response

Plock,1

Wait 300ms

1	0
Dec	Null

Plock,0

Wait 300ms

1	0
Dec	Null

Plock,?

Wait 300ms

1	?Plock,1	0
Dec	ASCII	Null

Plock,1

Baud, 9600

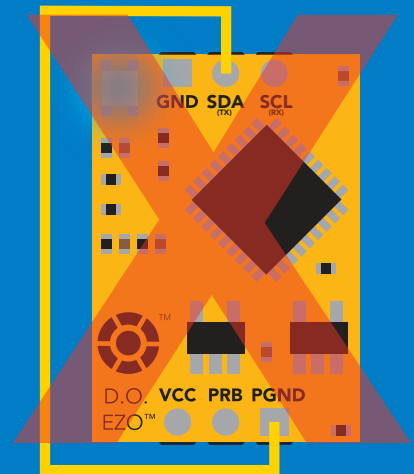
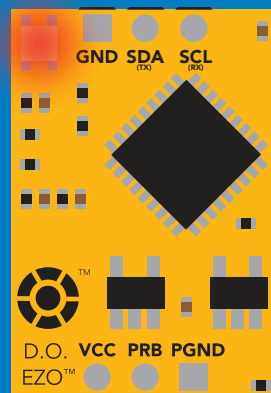
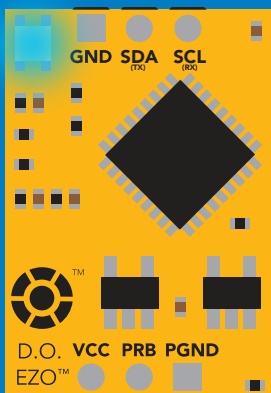

cannot change to UART

cannot change to UART

I²C address change

Command syntax

300ms  processing delay

I2C,n sets I²C address and reboots into I²C mode

Example

Response

I2C,100

device reboot

Warning!

Changing the I²C address will prevent communication between the circuit and the CPU until your CPU is updated with the new I²C address.

Default I²C address is 97 (0x61).

n = any number 1 – 127

I2C,100

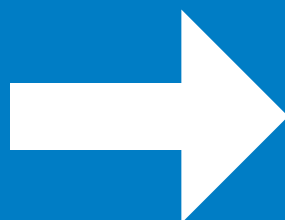
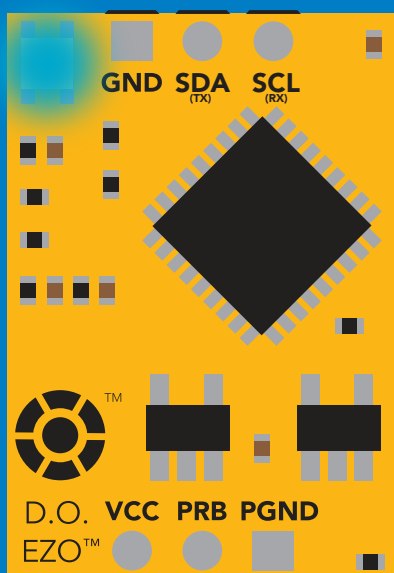

(reboot)

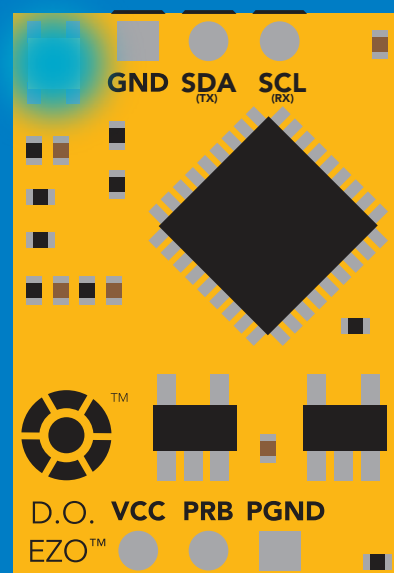

Factory reset

Command syntax

Factory reset will not take the device out of I²C mode.

Factory enable factory reset

I²C address will not change

Example

Response

Factory

device reboot

Clears calibration
LED on
Response codes enabled

Factory

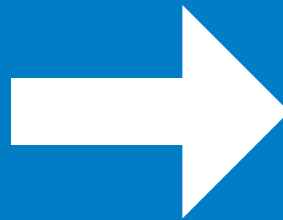
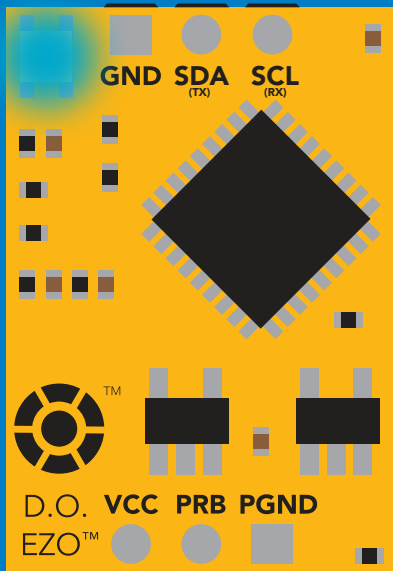

(reboot)

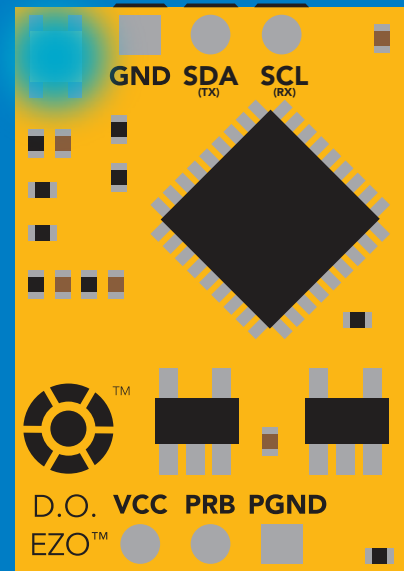

Change to UART mode

Command syntax

Baud,n switch from I²C to UART

Example

Baud,9600

Response

reboot in UART mode

n = [300
1200
2400
9600
19200
38400
57600
115200

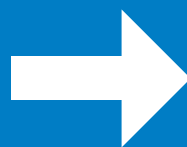
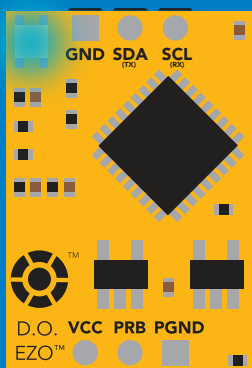

Baud,9600

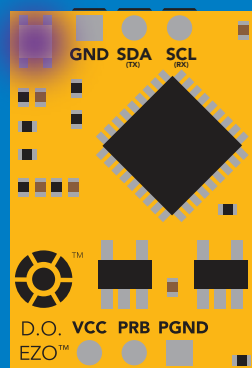

Changing to
UART mode

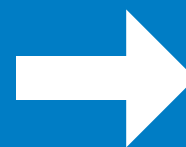

(reboot)

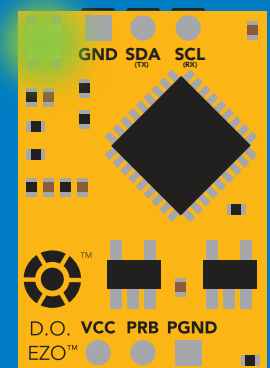

Manual switching to UART

- Disconnect ground (power off)
- Disconnect TX and RX
- Connect TX to PGND
- Confirm RX is disconnected
- Connect ground (power on)
- Wait for LED to change from Blue to Green
- Disconnect ground (power off)
- Reconnect all data and power

Example

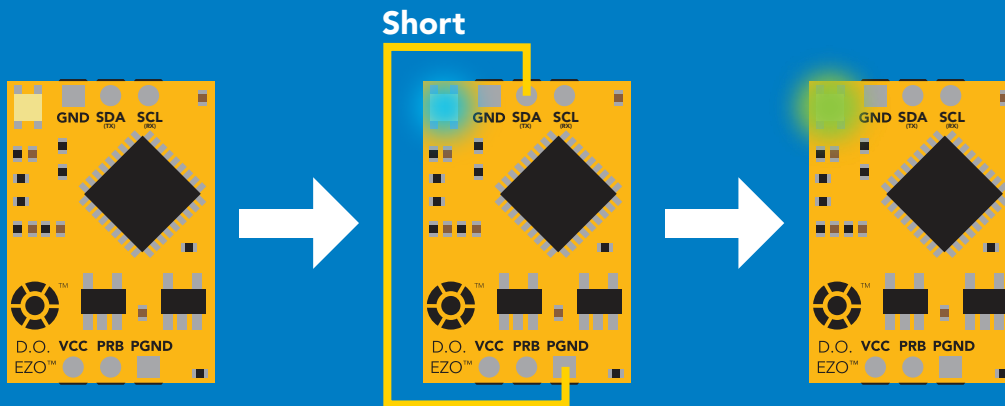

Wrong Example

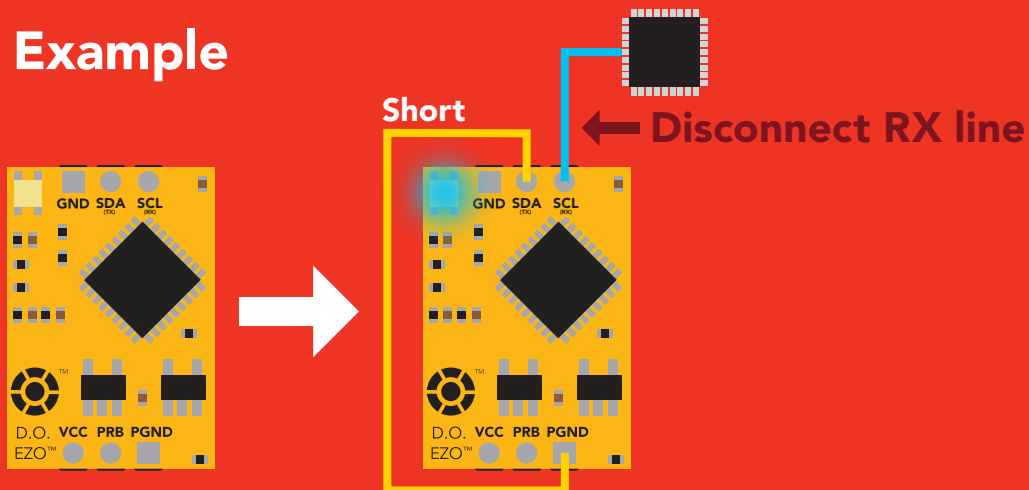

EZO™ circuit footprint

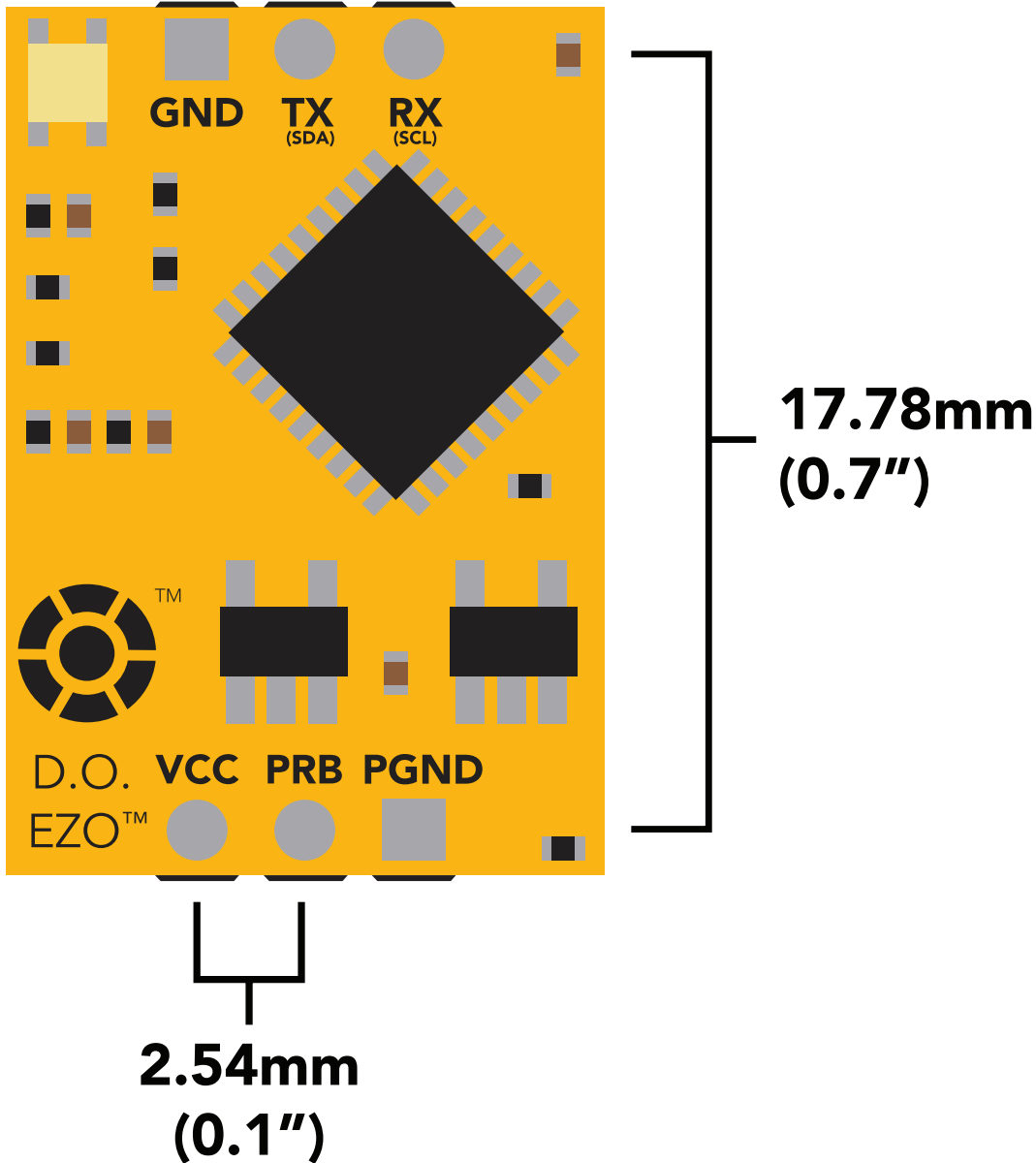

1 In your CAD software place a 8 position header.

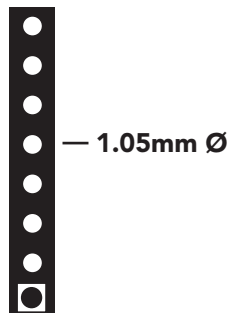

2 Place a 3 position header at both top and bottom of the 8 position.

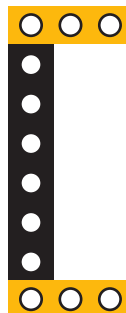

3 Delete the 8 position header. The two 3 position headers are now 17.78mm (0.7") apart from each other.

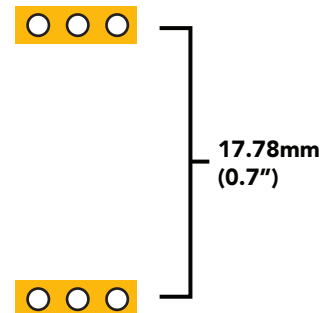

Datasheet change log

Datasheet V 5.4

Revised artwork within datasheet.

Datasheet V 5.3

Moved Default state to pg 13.

Datasheet V 5.2

Updated firmware changes on page 70.

Datasheet V 5.1

Revised response for the sleep command in UART mode on pg 36.

Datasheet V 5.0

Revised calibration theory on page 9, and added more information on the Export calibration and Import calibration commands.

Datasheet V 4.9

Corrected temperature compensation typo on pages 26 & 52.

Datasheet V 4.8

Revised isolation schematic on pg. 10

Datasheet V 4.7

Added new command:

"RT,n" for Temperature compensation located on pages 26 (UART) & 52 (I²C).

Added firmware information to Firmware update list.

Datasheet V 4.6

Added more information about temperature compensation on pages 26 & 52.

Datasheet V 4.5

Changed "Max rate" to "Response time" on cover page.

Datasheet V 4.4

Removed note from certain commands about firmware version.

Datasheet V 4.3

Added information to calibration theory on pg 7.

Datasheet V 4.2

Revised definition of response codes on pg 44.

Datasheet V 4.1

Updated firmware changes on pg. 66.

Datasheet V 4.0

Revised Enable/disable parameters information on pages 29 (UART) & 55 (I²C).

Datasheet V 3.9

Revised information on cover page.

Datasheet V 3.8

Update firmware changes on pg. 66.

Datasheet V 3.7

Revised Plock pages to show default value.

Datasheet change log

Datasheet V 3.6

Added new commands:

"Find" pages 21 (UART) & 48 (I²C).

"Export/Import calibration" pages 25 (UART) & 51 (I²C).

Added new feature to continuous mode "C,n" pg 22.

Datasheet V 3.5

Added accuracy range on cover page, and revised isolation info on pg. 10.

Datasheet V 3.4

Added manual switching to UART information on pg. 59.

Datasheet V 3.3

Updated firmware changes to reflect V1.99 update.

Datasheet V 3.2

Revised entire datasheet.

Firmware updates

V1.1 – Initial release (Oct 30, 2014)

- Change output to mg/L, then percentage (was previously percentage, then mg/L).

V1.5 – Baud rate change (Nov 6, 2014)

- Change default baud rate to 9600

V1.6 – I²C bug (Dec 1, 2014)

- Fixed I²C bug where the circuit may inappropriately respond when other I²C devices are connected.

V1.7 – Factory (April 14, 2015)

- Changed "X" command to "Factory"

V1.95 – Plock (March 31, 2016)

- Added protocol lock feature "Plock"

V1.96 – EEPROM (April 26, 2016)

- Fixed bug where EEPROM would get erased if the circuit lost power 900ms into startup.

V1.97 – EEPROM (Oct 10, 2016)

- Fixed bug in the cal clear command, improves how it calculates the DO, adds calibration saving and loading.

V1.98 – EEPROM (Nov 14, 2016)

- Updated firmware for new circuit design.

V1.99 – (Feb 2, 2017)

- Revised "O" command to accept mg.

V2.10 – (April 12, 2017)

- Added "Find" command.
- Added "Export/import" command.
- Modified continuous mode to be able to send readings every "n" seconds.

V2.11 – (Sept 28, 2017)

- Fixed bug where the temperature would default to 0 on startup.

V2.12 – (Dec 19, 2017)

- Improved accuracy of dissolved oxygen equations.

V2.13 – (July 16, 2018)

- Added "RT" command to Temperature compensation.

V2.14 – (June 7, 2019)

- Fixed bug where the output buffer overflows when the cal and cal,0 point are too close together.

Warranty

Atlas Scientific™ Warranties the EZO™ class Dissolved Oxygen circuit to be free of defect during the debugging phase of device implementation, or 30 days after receiving the EZO™ class Dissolved Oxygen circuit (which ever comes first).

The debugging phase

The debugging phase as defined by Atlas Scientific™ is the time period when the EZO™ class Dissolved Oxygen circuit is inserted into a bread board, or shield. If the EZO™ class Dissolved Oxygen circuit is being debugged in a bread board, the bread board must be devoid of other components. If the EZO™ class Dissolved Oxygen circuit is being connected to a microcontroller, the microcontroller must be running code that has been designed to drive the EZO™ class Dissolved Oxygen circuit exclusively and output the EZO™ class Dissolved Oxygen circuit data as a serial string.

It is important for the embedded systems engineer to keep in mind that the following activities will void the EZO™ class Dissolved Oxygen circuit warranty:

- Soldering any part of the EZO™ class Dissolved Oxygen circuit.
- Running any code, that does not exclusively drive the EZO™ class Dissolved Oxygen circuit and output its data in a serial string.
- Embedding the EZO™ class Dissolved Oxygen circuit into a custom made device.
- Removing any potting compound.

Reasoning behind this warranty

Because Atlas Scientific™ does not sell consumer electronics; once the device has been embedded into a custom made system, Atlas Scientific™ cannot possibly warranty the EZO™ class Dissolved Oxygen circuit, against the thousands of possible variables that may cause the EZO™ class Dissolved Oxygen circuit to no longer function properly.

Please keep this in mind:

- 1. All Atlas Scientific™ devices have been designed to be embedded into a custom made system by you, the embedded systems engineer.**
- 2. All Atlas Scientific™ devices have been designed to run indefinitely without failure in the field.**
- 3. All Atlas Scientific™ devices can be soldered into place, however you do so at your own risk.**

Atlas Scientific™ is simply stating that once the device is being used in your application, Atlas Scientific™ can no longer take responsibility for the EZO™ class Dissolved Oxygen circuits continued operation. This is because that would be equivalent to Atlas Scientific™ taking responsibility over the correct operation of your entire device.