



Optional super bright LEDs



Optional Green Digit Display

Optional Custom Faceplate

UM-35-CL

4-20mA Process Loop 3 1/2 DIGIT with 0.56" LEDs in a NEMA type 1 Style Case

Reliable Process Loop indicator with scalable capabilities from -1999 to +1999 to represent any engineering units, FLOW, LEVEL, TEMPERATURE, PRESSURE.....

General Features

The UM-35-CL is an cost-effective 4-20mA process loop measuring meter. It is easily user adjustable to any reading between -1999 and +1999 with header selectable signal conditioning.

Typical Application Connections

4 to 20mA Process Loop Measurement

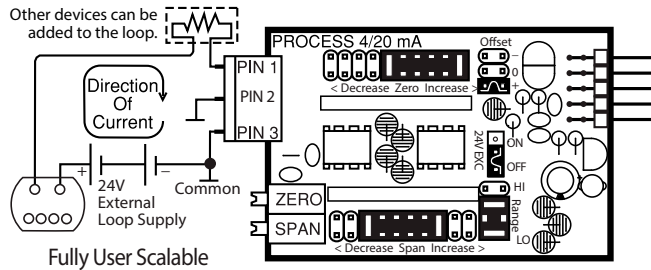

Order IP02, if you require the loop excitation voltage to be supplied by the meter.

Specifications

- Input Configuration:**.....Series connection to 4-20mA process loop.
- Full Scale Ranges:**.....User adjustable to any scaling between -1999 to +1999.
- Input Impedance:**.....70Ω. Maximum 1.4V drop
- A/D Converter:**.....12 Bit Dual Slope
- Accuracy:**.....±(0.05% of reading + 2 counts)
- Temperature Coefficient:** 100 ppm/°C (Typical)
- Warm Up Time:**.....2 minutes to specified accuracy
- Conversion Rate:**.....3 conversions per second (Typical)
- Display:**.....3 1/2 digit 0.56" Red LED display (std), Green or Super Bright Red are optional. Range -1999 to 1999 counts.
- Polarity:**.....Bipolar. Assumed positive displays negative.
- Decimal Selection:**.....Header under face plate, X•X•X•X•
- Over-range Indication:**....1 (MSD) displayed all other digits blank
- Power Supply (std):**.....120/240V AC, 50/60/400 Hz. approx 1.5W.
(Optn) VO-DC/ISO.....Isolated Switcher. 9 to 36V DC/12 to 24V AC
- Operating Temperature:**...-10 to 50 °C
- Storage Temperature:**.....-20 to 70 °C.
- Relative Humidity:**.....95% (non-condensing)
- Case Dimensions:**.....Bezel 3.78"Wx1.89"H (96mm x 48mm)
Depth behind bezel 3.36" (83.5mm) Plus 0.5 to .9" (12.7 to 22.8mm) depending on connector used.
- Weight:**.....NW. 12oz (0.34kg)
15.6oz (0.44kg). when packed.

UM-Series utility meters for switchboard and process indication

- UM-35-ACA**.....AC amps, Scaled or True RMS, (1 or 5 Amp internal shunt), 3.5 digit.
- UM-35-ACV**.....AC volts, Scaled or True RMS. 199.9V AC/700V AC header selectable ranges, 3.5 digit.
- UM-35-DCA**.....DC mV ±20mV/±50mV/±100mV/±200mV header selectable ranges, 3.5 digit
- UM-35-DCV**.....DC Volts ±2V/±20V/±200V DC header selectable ranges, 3.5 digit.
- UM-40-ACA**.....AC amps, Scaled or True RMS, (1 or 5 Amp internal shunt), 4.0 digit.
- UM-40-ACV**.....AC volts, Scaled or True RMS. 199.9V AC/700V AC header selectable ranges, 4.0 digit.
- UM-45-DCA**.....DC mV ±20mV/±50mV/±100mV/±200mV header selectable ranges, 4.5 digit
- UM-45-DCV**.....DC Volts ±2V/±20V/±200V DC Header selectable ranges, 4.5 digit.

- UM-35-CL**.....Process 4 to 20mA (100.0), optional 24V DC excitation ,easily user scalable in engineering units from -1999 to +1999. 3.5 digit
- UM-35-HZ**.....15Hz to 199.9Hz or optional 40Hz to 400Hz up to 500V AC , 3.5 digit.
- UM-35-Pressure**.....Pressure, strain gage and load cell, 4 and 6 wire, 5V DC excitation, Header Selectable Sensitivity 2mV/V, 5mV/V, 10mV/V, 20mV/V, 3.5 digit
- UM-35-JF**.....J thermocouple input, 1° resolution, order °C or °F, 3.5 digit
- UM-35-KF**.....K thermocouple input, 1° resolution, order °C or °F, 3.5 digit
- UM-35-RTD/F**.....100Ω platinum RTD, 3 or 4 wire, order °C or °F and 0.1° or 1°, 3.5 digit
- UM-45-CL**.....Process 4 to 20mA (100.0), optional 24V DC excitation ,easily user scalable in engineering units from -19999 to +19999. 4.5 digit

Decimal Point Selection

Decimal selection is made by moving the jumper to the indicated position on the header for the decimal required on the front of the display board.

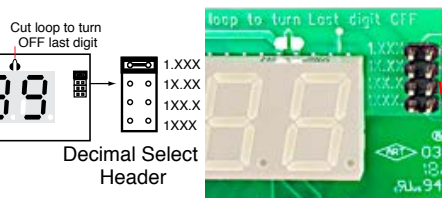

To open meter, insert a flat head screwdriver or similar instrument in both slots on the side of the cover and pry open. The UM-Series meters slide out from the front of the case as a complete assembly.

Component Layout

Optional Isolated auto-sensing
AC/DC 9 to 36V DC / 12 to 24V AC
P.N.: PS7

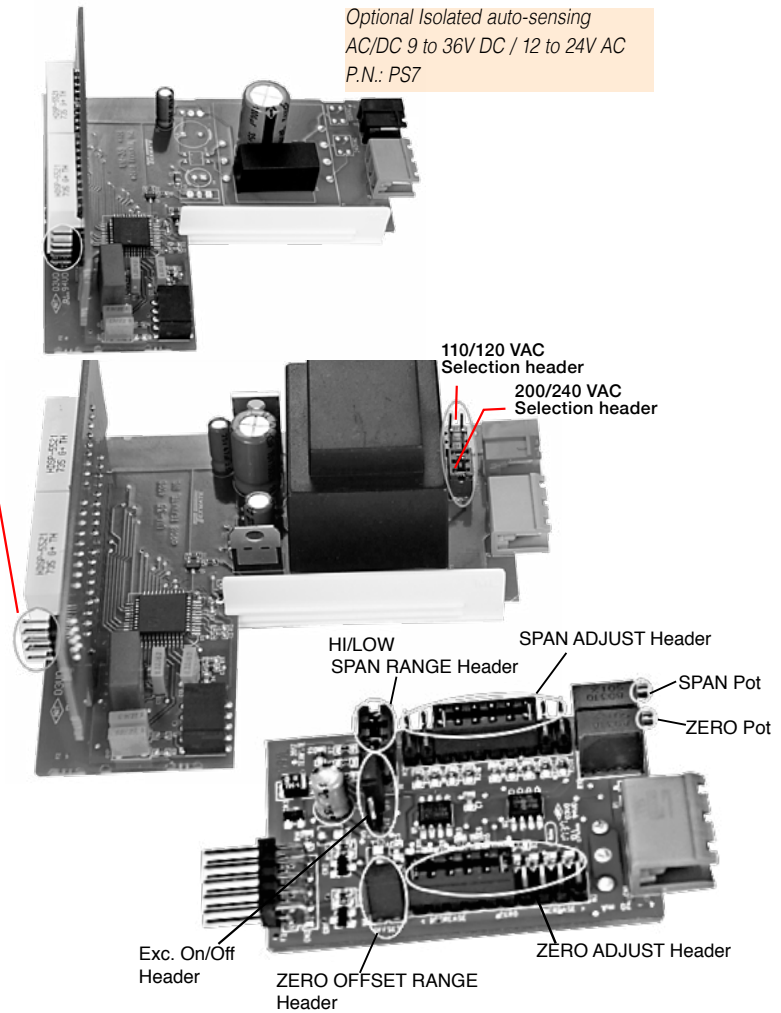

Calibration Procedure

The first step is to disengage the ZERO Pot and scale down the Signal Span input to produce the desired Digital Display Span output.

Signal Span is defined as the total change of signal input that would be required for a specific change of the Digital Display. The largest Signal Span that can be specified with a 4 to 20mA input is 16mA. A 4mA Signal Span proportionately scaled can meet full scale display accuracy.

Digital Display Span is defined as the exact total in counts, that the display would change within a specific Signal Span. The largest Digital Display Span that can be displayed is -1999 to +1999 (4000 counts). 16mA can not display +4000, so instead 4mA can be scaled to +1000.

The second step is to select a Zero Offset Range and offset the Digital Display Span with the ZERO Pot, until the desired reading is displayed.

Maximum offset is -3000 to +2000 counts. A Digital Display Span of 4000 counts requires an offset of -3000 to display -1999 to +1999.

For example: A 4 to 20mA input to read -40.0°C to +199.9°C
Signal Span = 16mA, Digital Display Span = 2400 counts.

1. Remove the meter from its case and set the Zero Offset Range Header to the Calibrate position. Select the 1400 – 3000 position on the Span Adjust Header and slide the meter back into the case.
2. Connect power to the meter and apply 4mA (25% of 16mA). Adjust the SPAN Pot until the display reads +600 (25% of 2400). The meter is now scaled for a Signal Span of 16mA and a Digital Display Span of 2400 counts. In the example 4mA should read -400 and 20mA read 1999, therefore the Digital Display Span should be offset by -1000.
3. Disconnect power and remove the meter from the case, select the Negative offset position on the ZERO OFFSET RANGE Header, and slide the meter back into the case.
4. Connect power to the meter, apply 4mA and adjust the ZERO Pot until the display reads -400. With the Digital Display Span now offset by -1000 counts, the meter will read -400 for a 4mA input, and read +1999 for a 20mA input. Select decimal point 1XX.X to display -40.0 to +199.9. Then apply the self adhesive °C symbol (from the Face Plate Descriptor sheet may be ordered. P.N:DU-CASEDES) to complete the calibration.

Connector Pinouts

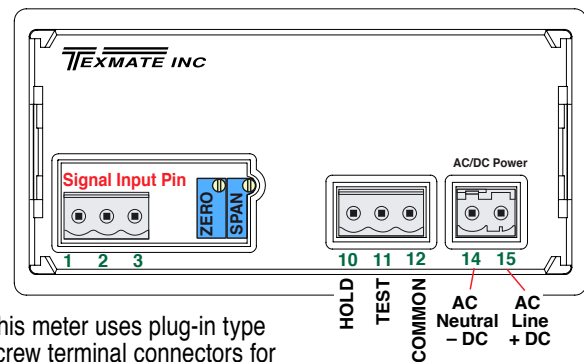

This meter uses plug-in type screw terminal connectors for all connections.

Connectors

This meter uses plug-in type screw terminal connectors for all input and output connections. The power supply connections (pins 14 and 15) have a unique plug and socket outline to prevent cross connection. The main board uses standard right-angled connectors.

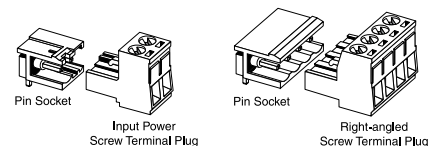

WARNING: AC and DC input signals and power supply voltages can be hazardous. Do Not connect live wires to screw terminal plugs, and do not insert, remove or handle screw terminal plugs with live wires connected.

SPAN RANGE Header

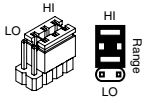

When this header is provided it works in conjunction with the SPAN ADJUST Header by splitting its adjustment range into a Hi and a Lo range. This has the effect of dividing the adjustment range of the SPAN pot into ten equal 10% steps across 100% of the input Signal Span.

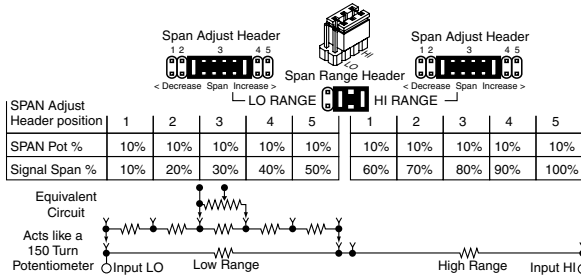

SPAN ADJUST Header

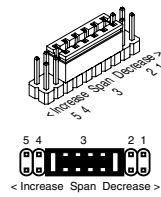

This unique five-position header expands the adjustment range of the SPAN pot into five equal 20% steps, across 100% of the input Signal Span. Any input Signal Span can then be precisely scaled down to provide any required Digital Display span from 1999 counts to 001 (one count).

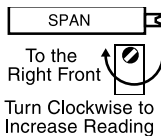
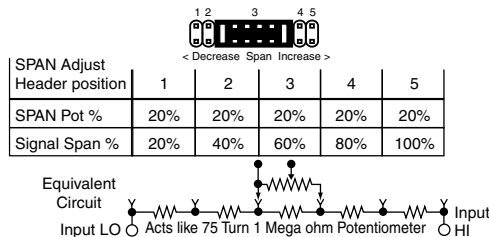

SPAN Potentiometer (Pot)

The 15 turn SPAN pot is always on the right side (as viewed from the front of the meter). Typical adjustment is 100% of the input signal range.

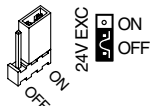

24V DC Output Header

On some modules this header enables a 24V DC 125mA (max) Excitation/Auxiliary output to be connected to Pin 3.

ZERO OFFSET RANGE Header

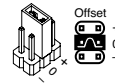

When provided, this three position header increases the ZERO pot's capability to offset the input signal, to $\pm 25\%$ of the digital display span. For example a Negative offset enables a 1 to 5V input to display 0 to full scale. The user can select negative offset, positive offset, or no offset (ZERO pot disabled for two step non-interactive span and offset calibration).

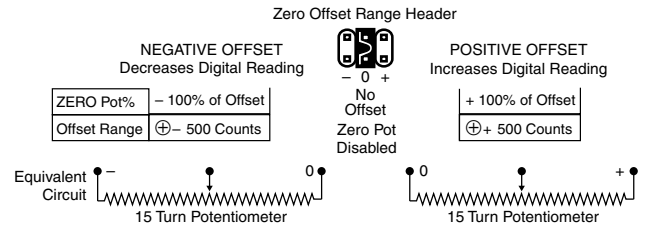

ZERO ADJUST Header

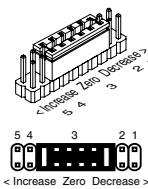

When this header is provided, it works in conjunction with the ZERO OFFSET RANGE Header, and expands the ZERO pot's offset capability into five equal negative steps or five equal positive steps. This enables virtually any degree of input signal offset required to display any desired engineering unit of measure.

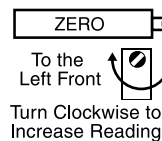
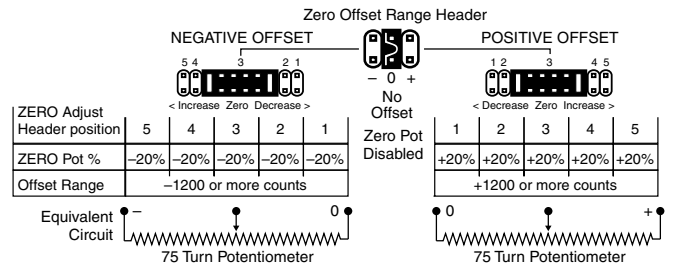

ZERO Potentiometer (Pot)

The Optional ZERO pot when installed is always to the left of the SPAN pot (as viewed from the front of the meter). Typically it enables the displayed reading to be offset ± 100 counts.

Optional Face Plate Descriptors

AC	V	KV	KVAR	mVA	Hz	RPM
V	mV	min	PF	F	C	Case
DC	mA	µA	PSIG	mS	psi	
KW	W	KWH	pH	%	K	KPa
A	mbar	mA	MW	KA	RPS	MWH
nWS	µm	KW/s	I	V/sec	ml	cm
DRP	mm/s	1/min	mm	kg/s	lbs	mm
BT	bars	min	mm	Mw/s	µV	dB

To customize the face plate, clear adhesive label containing various popular descriptors may be ordered. Choose the descriptor desired, peel off the adhesive backing and align the descriptor in the center right of the face plate.

P.N.: DU-CASEDES

UM Case Dimensions and Panel Cutouts

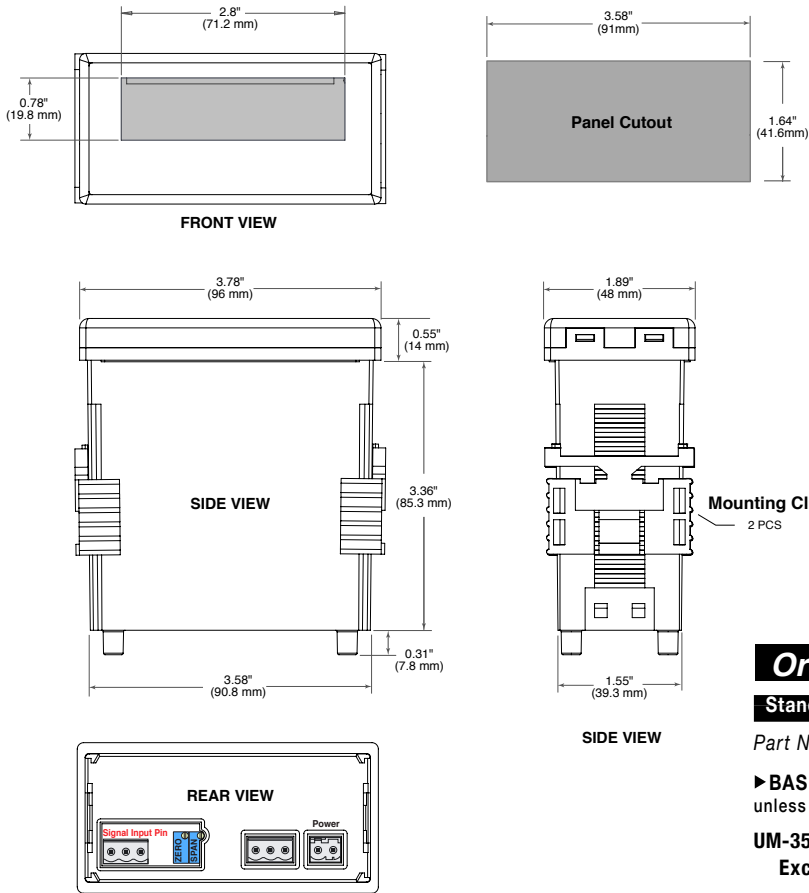

Warranty and User's Responsibility

WARRANTY

Texmate warrants that its products are free from defects in material and workmanship under normal use and service for a period of one year from date of shipment. Texmate's obligations under this warranty are limited to replacement or repair, at its option, at its factory, of any of the products which shall, within the applicable period after shipment, be returned to Texmate's facility, transportation charges pre-paid, and which are, after examination, disclosed to the satisfaction of Texmate to be thus defective. The warranty shall not apply to any equipment which shall have been repaired or altered, except by Texmate, or which shall have been subjected to misuse, negligence, or accident. In no case shall Texmate's liability exceed the original purchase price. The aforementioned provisions do not extend the original warranty period of any product which has been either repaired or replaced by Texmate.

USER'S RESPONSIBILITY

We are pleased to offer suggestions on the use of our various products either by way of printed matter or through direct contact with our sales/application engineering staff. However, since we have no control over the use of our products once they are shipped, NO WARRANTY WHETHER OF MERCHANTABILITY, FITNESS FOR PURPOSE, OR OTHERWISE is made beyond the repair, replacement, or refund of purchase price at the sole discretion of Texmate. Users shall determine the suitability of the product for the intended application before using, and the users assume all risk and liability whatsoever in connection therewith, regardless of any of our suggestions or statements as to application or construction. In no event shall Texmate's liability, in law or otherwise, be in excess of the purchase price of the product.

Texmate cannot assume responsibility for any circuitry described. No circuit patent or software licenses are implied. Texmate reserves the right to change circuitry, operating software, specifications, and prices without notice at any time.

Ordering Information

Standard Options for this Model Number

Part Number	Description
► BASIC MODEL NUMBER standard display and standard power supply unless optional versions are ordered.	
UM-35-CL	DPM, Process 4 to 20mA (100.0), (IP01)
Exc. option	with 24V Excitation, (IP02)
► DISPLAY	
DR	0.56" Red LEDs
UM-BRIGHTSuper bright Red LEDs, 0.56 inch high
UM-GREENGreen LEDs, 0.56 inch high
► POWER SUPPLY	
PS6	100/120 or 200/240VAC 60/50Hz User selectable
PS7Isolated auto-sensing AC/DC 9 to 36V DC/12 to 24V AC ...

Special Options and Accessories

Part Number	Description
► SPECIAL OPTIONS (Specify Inputs & Req. Reading)	
ZRInput Range Change to another Standard Range
ZRS-SMUMNon-standard range change and/or Scale change

► ACCESSORIES

OP-N4X/96X48.96x48mm clear lockable front cover NEMA 4X, splash proof
CASE.RPUM...Case: Replacement with Accessories

ART-FS-S/D...NRC for Artwork & set-up Custom Faceplate and or Descriptor
ART-FS-001...Produce & Install Custom Faceplate per meter - 1 color no-min
ART-FS-002...Produce & Install Custom Faceplate per meter - 2 color no-min
ART-FS-003...Produce & Install Custom Faceplate per meter - 3 color no-min
DU-CASEDES.....Clear adhesive descriptors label for face plate

Custom Face Plates

Texmate Produces Thousands of Custom OEM Face Plates.
Have Texmate Design and produce a Custom Face Plate for your next project!

• Custom face plates have a non-recurring artwork charge. A serial number is then assigned to each artwork to facilitate reordering.

UM-35-CL Technical Manual Copyright © 2018 Texmate Inc. All rights reserved. Published by: Texmate Inc. USA. Information in this Technical Manual is subject to change without notice due to correction or enhancement. The information described in this manual is proprietary to Texmate, Inc. and may not be copied, reproduced or transmitted, in whole or in part, in connection with the design, manufacture, or sale of apparatus, device or private label product without the express written consent of Texmate, Inc.

Clear Lockable Water-proof Cover

The clear lockable cover is designed to be dust and waterproof to NEMA-4X, IP65 standards. The assembly consists of a base and a cover with a cam hinge and key-lock fastening mechanism. An O-ring, or neoprene gasket forms a seal between the base and the panel. The cam hinge prevents the cover from closing when opened until pushed closed. The cover has a tapered recess that, when closed, forms a seal with a tapered spigot on the base. A key-lock employs a cam locking device to force the spigot into the recess, ensuring seal integrity. A safety catch keeps the cover closed even when the key is removed,

preventing unauthorized opening.

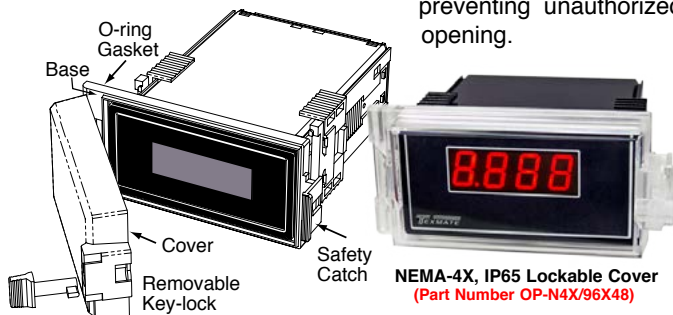

NEMA-4X, IP65 Lockable Cover
(Part Number OP-N4X/96X48)



1934 Kellogg Ave., Carlsbad, CA 92008
Tel: 1-760-598-9899 • 1-800-TEXMATE
Fax: 1-760-598-9828 • Email: orders@texmate.com