



Micro Commercial Components



Micro Commercial Components
20736 Marilla Street Chatsworth
CA 91311
Phone: (818) 701-4933
Fax: (818) 701-4939

**2SA1464-P
2SA1464-Q
2SA1464-R**

Features

- High f_T : $f_T=400\text{MHZ}$
- Epoxy meets UL 94 V-0 flammability rating
- Moisture Sensitivity Level 1
- Lead Free Finish/RoHS Compliant ("P" Suffix designates RoHS Compliant. See ordering information)
- Halogen free available upon request by adding suffix "-HF"

Maximum Ratings @ $T_a = 25^\circ\text{C}$ (unless otherwise noted)

Symbol	Parameter	Value	Unit
I_C	Collector Current	-0.5	A
P_D	Collector Power Dissipation	0.2	W
T_J	Junction Temperature	150	$^\circ\text{C}$
T_{STG}	Storage Temperature Range	-55 to +150	$^\circ\text{C}$

Electrical Characteristics @ 25°C Unless Otherwise Specified

Symbol	Parameter	Min	TYPE	Max	Units
OFF CHARACTERISTICS					
V_{CEO}	Collector-Emitter Breakdown Voltage	-40			V
V_{CBO}	Collector-Base Breakdown Voltage	-60			V
V_{EBO}	Collector-Base Breakdown Voltage	-5.0			V
I_{CBO}	Collector-Base Cutoff Current ($V_{CB}=-40\text{Vdc}$, $I_E=0$)			- 100	nAdc
I_{EBO}	Emitter-Base Cutoff Current ($V_{EB}=-4.0\text{Vdc}$, $I_C=0$)			- 100	nAdc

ON CHARACTERISTICS

H_{FE}	DC Current Gain ($I_C=-150\text{mAdc}$, $V_{CE}=-2.0\text{Vdc}$) ($I_C=-500\text{mAdc}$, $V_{CE}=-2.0\text{Vdc}$)	75 20	140 50	300	
$V_{CE(sat)}$	Collector-Emitter Saturation Voltage * ($I_C=-500\text{mAdc}$, $I_B=-50\text{mAdc}$)		-0.45	-0.75	Vdc
$V_{BE(sat)}$	Base-Emitter Saturation Voltage * ($I_C=-500\text{mAdc}$, $I_B=-50\text{mAdc}$)		-1	-1.3	Vdc
F_T	Gain bandwidth product ($V_{CE}=-10\text{Vdc}$, $I_E=20\text{mAdc}$)	150	400		MHZ
C_{ob}	($V_{CB}=-10\text{Vdc}$, $I_E=0$, $f=1\text{MHZ}$)		5	8	pF
T_{on}	Turn-on time	$V_{CC}=-30\text{V}$,		35	ns
T_{stg}	Storage time	$I_C=150\text{mA}$,		225	ns
T_{off}	Turn-off time	$I_{B1}=-I_{B2}=15\text{mA}$		255	ns

**PNP Silicon
Epitaxial Transistors**

SOT-23

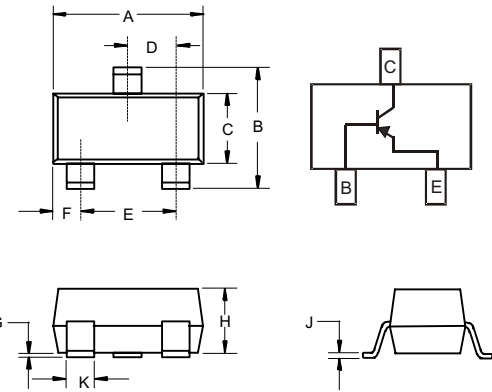

DIM	INCHES		MM		NOTE
	MIN	MAX	MIN	MAX	
A	.110	.120	2.80	3.04	
B	.083	.104	2.10	2.64	
C	.047	.055	1.20	1.40	
D	.035	.041	.89	1.03	
E	.070	.081	1.78	2.05	
F	.018	.024	.45	.60	
G	.0005	.0039	.013	.100	
H	.035	.044	.89	1.12	
J	.003	.007	.085	.180	
K	.015	.020	.37	.51	

**Suggested Solder
Pad Layout**

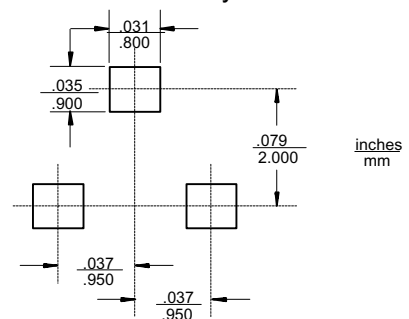

CLASSIFICATION OF h_{FE}

Rank	P	Q	R
Range	75-150	100-200	150-300
Marking	Y12	Y13	Y14

2SA1464 Typical Characteristics

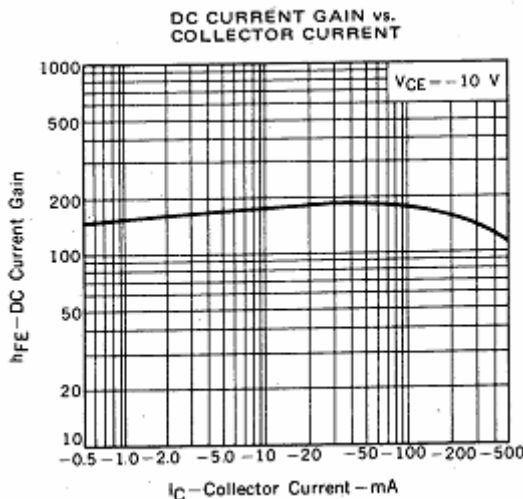
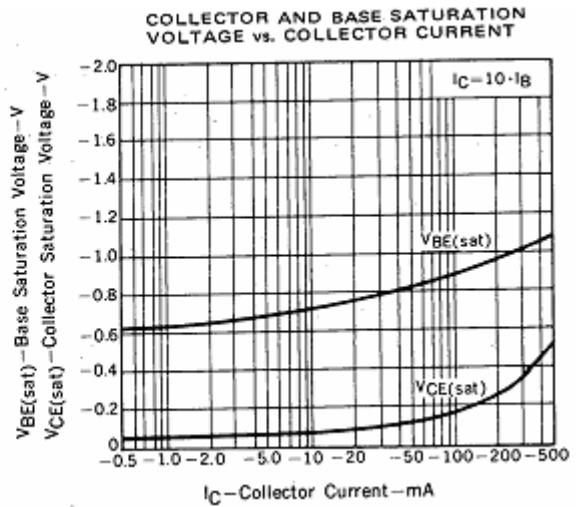
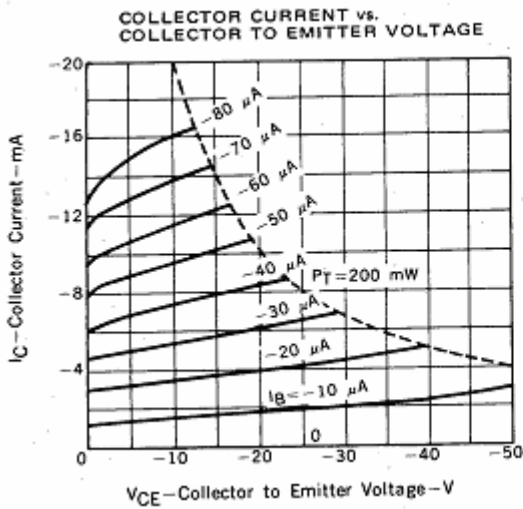
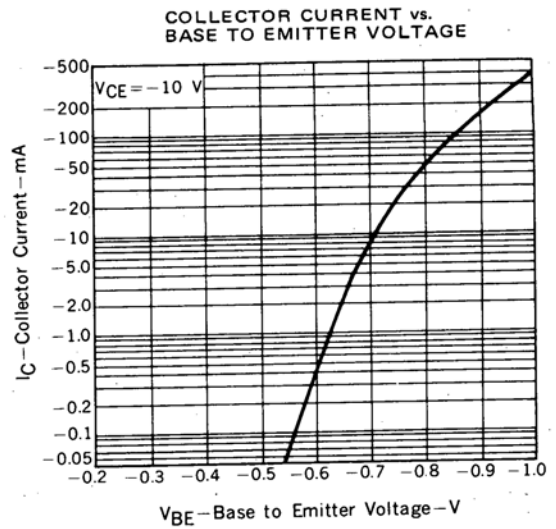
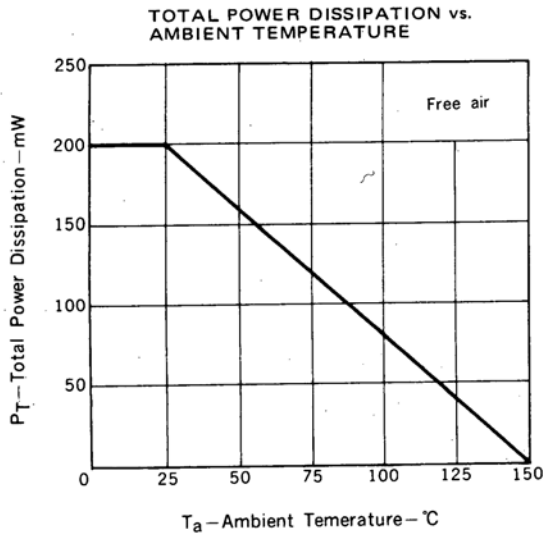

2SA1464 Typical Characteristics

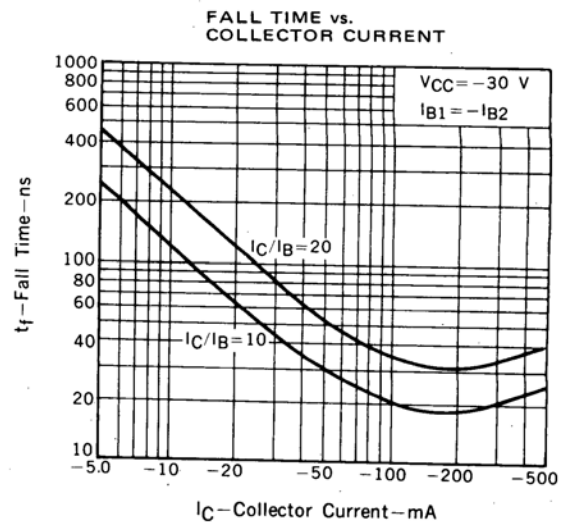
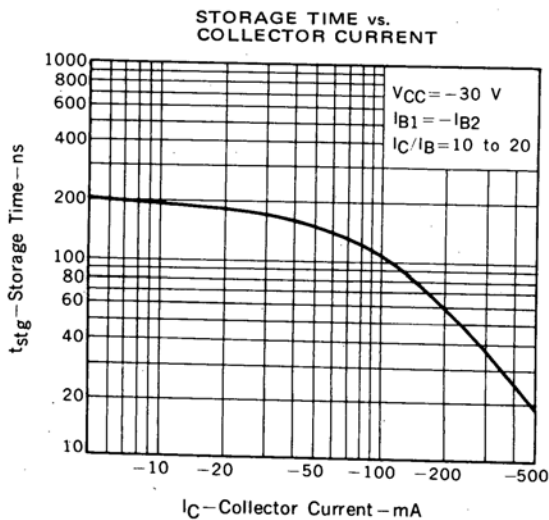
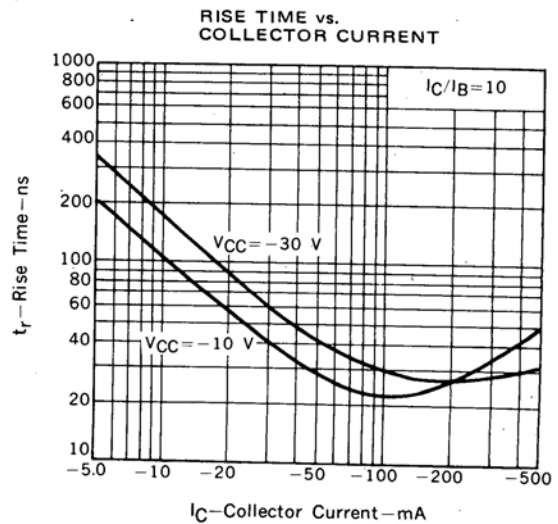
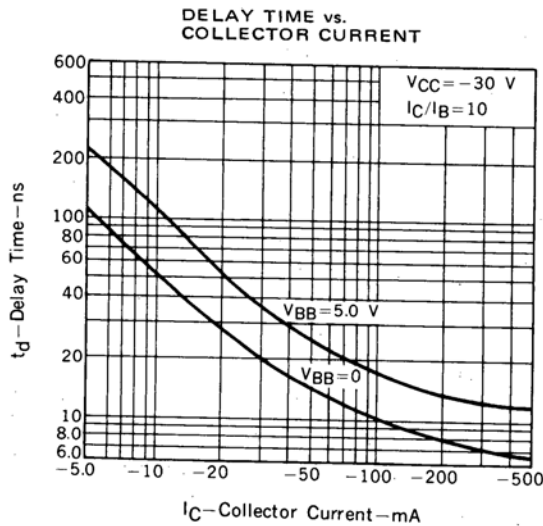
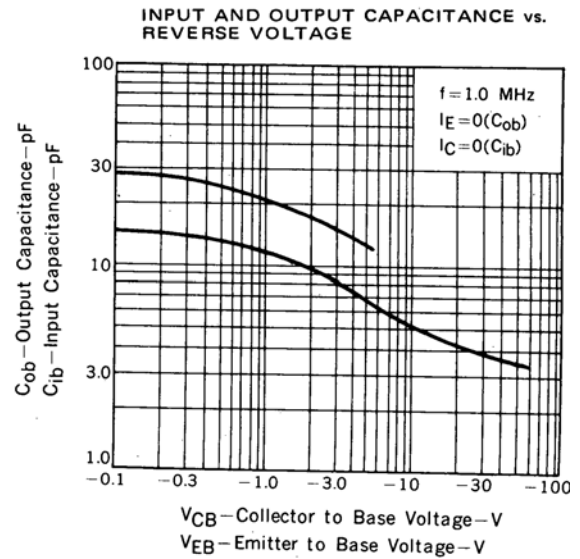
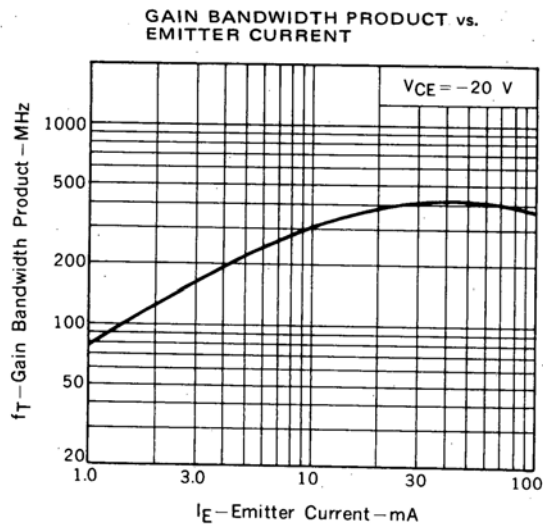



Micro Commercial Components

Ordering Information :

Device	Packing
Part Number-TP	Tape&Reel; 3Kpcs/Reel

Note : Adding "-HF" suffix for halogen free, eg. Part Number-TP-HF

IMPORTANT NOTICE

Micro Commercial Components Corp. reserves the right to make changes without further notice to any product herein to make corrections, modifications, enhancements, improvements, or other changes. **Micro Commercial Components Corp.** does not assume any liability arising out of the application or use of any product described herein; neither does it convey any license under its patent rights, nor the rights of others. The user of products in such applications shall assume all risks of such use and will agree to hold **Micro Commercial Components Corp.** and all the companies whose products are represented on our website, harmless against all damages.

LIFE SUPPORT

MCC's products are not authorized for use as critical components in life support devices or systems without the express written approval of Micro Commercial Components Corporation.

CUSTOMER AWARENESS

Counterfeiting of semiconductor parts is a growing problem in the industry. Micro Commercial Components (MCC) is taking strong measures to protect ourselves and our customers from the proliferation of counterfeit parts. MCC strongly encourages customers to purchase MCC parts either directly from MCC or from Authorized MCC Distributors who are listed by country on our web page cited below. Products customers buy either from MCC directly or from Authorized MCC Distributors are genuine parts, have full traceability, meet MCC's quality standards for handling and storage. **MCC will not provide any warranty coverage or other assistance for parts bought from Unauthorized Sources.** MCC is committed to combat this global problem and encourage our customers to do their part in stopping this practice by buying direct or from authorized distributors.

www.mccsemi.com