

THIS IS A C.A.D. GENERATED DRAWING
DO NOT MAKE MANUAL REVISIONS TO MASTER.

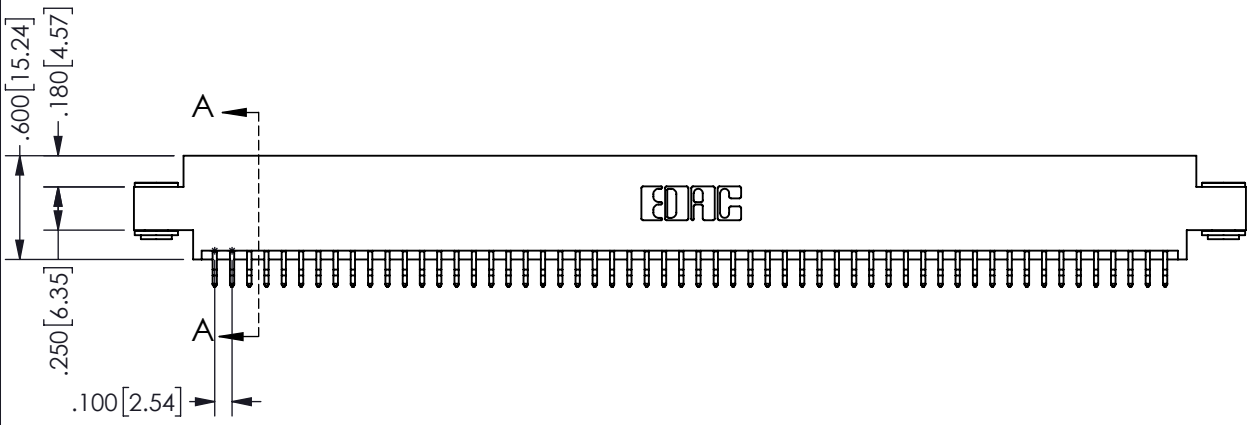

| | |
|--------------|---|
| ISSUE NUMBER | |
| ORIGINAL | ① |

CARD SLOT ACCEPTS
.054" [1.37] TO .070" [1.78]
THICK PCB



SECTION A-A

Contact Dimensions:
556-Extender Board Bend (Code 520 Contacts)
See Sheet 2 for Contact Code 555, 556, 558, 559, 560
Dimensions

| | | | |
|--|--|---------------------|-------------------|
| 345/395 SERIES CARD EDGE CONNECTOR PART NUMBER: 345-112-556-803 | | ACAD REFERENCE NO. | 345-ENG-MASTER |
| | | DRAWN: R.STA.MONICA | DATE: MAY.16/2017 |
|  | | CHECKED: | DATE: |
| EDAC INC TORONTO, ONTARIO CANADA YOUR CONNECTION TO QUALITY & SERVICE | | SCALE: NTS | SHEET 1 OF 2 |
| THESE DRAWINGS AND SPECIFICATIONS ARE THE PROPERTY OF EDAC INC. AND SHALL NOT BE REPRODUCED, OR COPIED OR USED AS THE BASIS FOR THE MANUFACTURE OR SALE OF APPARATUS WITHOUT WRITTEN PERMISSION. | | DRAWING NUMBER | ISSUE |
| | | 345-ENG-MASTER | 1 |

Contact Description:
559-90 Degree Bend (Code 541 Contacts)

THIS IS A C.A.D. GENERATED DRAWING
 DO NOT MAKE MANUAL REVISIONS TO MASTER.



| | |
|--------------|---|
| ISSUE NUMBER | |
| ORIGINAL | ① |



Contact Code 555



Contact Code 556



Contact Code 558



Contact Code 559



Contact Code 560

- INSULATOR MATERIAL: THERMOPLASTIC POLYESTER, UL 94V-0
- DAP MATERIAL AVAILABLE UPON REQUEST
- CONTACT MATERIAL: COPPER ALLOY
- CONTACT PLATING: GOLD ON THE MATING AREA, TIN PLATING ON THE CONTACT TAILS, NICKEL UNDERPLATE

**345/395 SERIES CARD EDGE CONNECTOR
 CONTACT CODE 555,556,558,559,560 DIMENSIONS**



EDAC INC
 TORONTO, ONTARIO
 CANADA

YOUR CONNECTION TO QUALITY & SERVICE

THESE DRAWINGS AND SPECIFICATIONS
 ARE THE PROPERTY OF EDAC INC. AND
 SHALL NOT BE REPRODUCED, OR COPIED
 OR USED AS THE BASIS FOR THE
 MANUFACTURE OR SALE OF APPARATUS
 WITHOUT WRITTEN PERMISSION.

| | |
|----------------------------------|-------------------|
| ACAD REFERENCE NO. | 345-ENG-MASTER |
| DRAWN: R.STA.MONICA | DATE: MAY.16/2017 |
| CHECKED: | DATE: |
| SCALE: 1:1 | SHEET 2 OF 2 |
| DRAWING NUMBER 345-ENG-MASTER | ISSUE 1 |