

Data sheet | Item number: 770-823

Socket for PCBs; straight; 3-pole; Cod. A; white

[www.wago.com/770-823](http://www.wago.com/770-823)

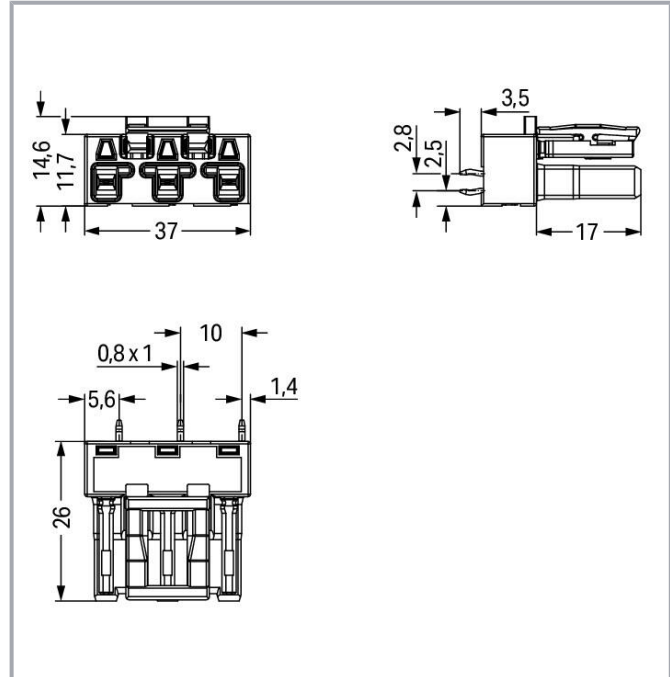

Color: 

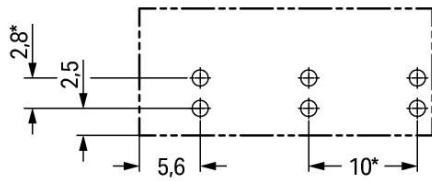

\* ± 0.05 mm  
Drilled hole diameter: 1.5<sup>+0.1</sup> mm

Subject to changes. Please also observe the further product documentation!

WAGO GmbH & Co. KG  
Hansastr. 27  
32423 Minden  
Phone: +49571 887-0 | Fax: +49571 887-169  
Email: [info.de@wago.com](mailto:info.de@wago.com) | Web: [www.wago.com](http://www.wago.com)

Do you have any questions about our products?  
We are always happy to take your call at +49 (571) 887-44222.



## Item description

### Female connector/socket WINSTA® MIDI with protection against mismatching

The WINSTA® MIDI female connector/socket A coding is economical and space thanks to its compact dimensions. Our remarkable number of pluggable PCB connectors with different insertion directions and operating variants offers you the perfect solution for your application at all times. The mechanical coding and color coding of the pcb connector ensure error-free installation of the individual components – including protection against mismatching. General mains applications for almost any domain of use can be implemented with WINSTA® MIDI pcb connectors with A coding. The rated current and voltage are important criteria for selecting a pcb connector: They provide information about possible domains of use and applications. This product has a current rating of 25 A – so it is also suitable for high power loads. WINSTA® MIDI with Push-in CAGE CLAMP® spring pressure connection technology is found in can be found in a variety of projects you can use for quick, easy, secure, tailored installation.

### Push-in CAGE CLAMP® spring pressure connection technology – pluggable installation instead of laborious screw connections!

WINSTA® is the pluggable connection system that is perfectly tailored to the strict requirements of electrical installation. It allows fast, secure and, above all, error-free installation of components and cables. Choose quality and durability – the WINSTA® MIDI pcb connector with protection against mismatching from WAGO makes the electrical installation of electrical components noticeably easier.

- 
- pcb connector with protection against mismatching
- simple circuits
- with A coding for a great number of uses
- convenient installation and commissioning

## Data

### Electrical data

#### Ratings per IEC/EN

Ratings per	IEC/EN 60664-1
Nominal voltage (III/3)	250 V
Rated impulse voltage (III/3)	4 kV
Rated current	25 A
Legend (ratings)	(III / 3) ≙ Overvoltage category III / Pollution degree 3

Subject to changes. Please also observe the further product documentation!

WAGO GmbH & Co. KG  
 Hansastr. 27  
 32423 Minden  
 Phone: +49571 887-0 | Fax: +49571 887-169  
 Email: [info.de@wago.com](mailto:info.de@wago.com) | Web: [www.wago.com](http://www.wago.com)

Do you have any questions about our products?  
 We are always happy to take your call at +49 (571) 887-44222.



## Ratings per UL 1977

Note for the US market

Some versions may also be used for current interruption in accordance with the UL certificate in select applications with currents below 16 A and voltages up to 600 V. For further information, please contact your local sales office.

Rated voltage (UL 1977)	600 V
Rated current UL 1977	23 A

## General

Note on contact resistance

approx. 1 mΩ of contact resistance  
approx. 0.25 mΩ contact transition plug/socket

## Connection data

Total number of potentials	3
Number of levels	1

## Connection 1

Pole number	3
-------------	---

## Physical data

Pin spacing	10 mm / 0.394 inches
Width	27 mm / 1.063 inches
Height	29.5 mm / 1.161 inches
Height from the surface	26 mm / 1.024 inches
Depth	14.6 mm / 0.575 inches
Solder pin length	3.5 mm
Solder pin dimensions	1 x 0.8 mm
Drilled hole diameter with tolerance	1.5 <sup>(-0.1 ... +0.1)</sup> mm

## Mechanical Data

Application	General mains applications
Coding	A
Variable coding	Yes
Marking	L $\frac{1}{2}$ N
Potential marking	L $\frac{1}{2}$ N

Subject to changes. Please also observe the further product documentation!

WAGO GmbH & Co. KG  
Hansastr. 27  
32423 Minden  
Phone: +49571 887-0 | Fax: +49571 887-169  
Email: [info.de@wago.com](mailto:info.de@wago.com) | Web: [www.wago.com](http://www.wago.com)

Do you have any questions about our products?  
We are always happy to take your call at +49 (571) 887-44222.



Mating force of a plug-in connection	approx. 20 ... 70 N (depending on pole number)
Retention force of a plug-in connection	Locked: > 80 N
Unmating force of a plug-in connection	Unlocked: approx. 20 ... 70 N (depending on pole number)
Number of mating cycles	200, without resistive load
Design	straight

## Plug-in connection

Contact type (pluggable connector)	Female connector/socket
Connector (connection type)	for PCB
Mismating protection	Yes
Note on mismating protection	All <i>WINSTA</i> <sup>®</sup> components are 100% protected against mismating when: a.) plugging different numbers of poles b.) plugging while rotated 180 c.) plugging while laterally staggered d.) plugging one pole
Mating direction to the PCB	90 °
Locking lever	yes
Locking of plug-in connection	locking lever
Note on locking system	All connectors for mounted installations (snap-in versions for lighting fixtures or devices, all types of PCB and distribution connectors) are factory-equipped with locking levers to ensure plugs and sockets are securely locked. Additional locking levers are only required for flying leads (plug/socket).

## PCB contact

PCB contact	THT
Solder pin arrangement	2 in-line solder pins/pole
Number of solder pins per potential	2

## Material Data

Note (material data)	Information on material specifications can be found here
Color	white
Insulation material	Polyamide (PA66)
Flammability class per UL94	V0
Clamping spring material	Chrome-nickel spring steel (CrNi)
Contact material	Copper or copper alloy; surface-treated

Subject to changes. Please also observe the further product documentation!

Contact plating	Tin
Fire load	0.117 MJ
Weight	6.3 g

### Environmental requirements

Processing temperature	-5 ... +40 °C
Continuous operating temperature	-35 ... +85 °C
Note on continuous operating temperature	Insulating parts for temperatures ≤ 105 °C

### Commercial data



eCl@ss 10.0	27-44-06-05
eCl@ss 9.0	27-44-06-05
ETIM 8.0	EC002560
ETIM 7.0	EC002560
PU (SPU)	100 pcs
Packaging type	box
Country of origin	PL
GTIN	4044918684675
Customs tariff number	85366990990

### Environmental Product Compliance

RoHS Compliance Status	Compliant, No Exemption
------------------------	-------------------------

### Approvals / Certificates

#### General approvals

Logo	Approval	Additional Approval Text	Certificate name
	CCA DEKRA Certification B.V.	EN 61535	71- 123228
	CCA DEKRA Certification B.V.	IEC 61535	NL -84761
	cURus Underwriters Laboratories Inc.	UL 1977	E45171

### Declarations of conformity and manufacturer's declarations



Subject to changes. Please also observe the further product documentation!

WAGO GmbH & Co. KG  
 Hansastr. 27  
 32423 Minden  
 Phone: +49571 887-0 | Fax: +49571 887-169  
 Email: [info.de@wago.com](mailto:info.de@wago.com) | Web: [www.wago.com](http://www.wago.com)





Do you have any questions about our products?  
 We are always happy to take your call at +49 (571) 887-44222.

Logo	Approval	Additional Approval Text	Certificate name
	EU-Declaration of Conformity WAGO GmbH & Co. KG	-	-

#### Approvals for marine applications

Logo	Approval	Additional Approval Text	Certificate name
	ABS American Bureau of Shipping	-	19- HG1868589- PDA
	DNV GL Det Norske Veritas, Germanischer Lloyd	-	TAE00001Z6
	LR Lloyds Register	IEC 61984	LR22429487TA



#### Counterpart

	<b>Item no.770-133</b> Plug; with strain relief housing; 3-pole; Cod. A; 4,00 mm <sup>2</sup> ; white	<a href="http://www.wago.com/770-133">www.wago.com/770-133</a>
	<b>Item no.770-233</b> Plug; 3-pole; Cod. A; 4,00 mm <sup>2</sup> ; white	<a href="http://www.wago.com/770-233">www.wago.com/770-233</a>
	<b>Item no.770-233/035-050</b> Plug; with strain relief housing; 3-pole; Cod. A; 4,00 mm <sup>2</sup> ; white	<a href="http://www.wago.com/770-233/035-050">www.wago.com/770-233/035-050</a>
	<b>Item no.771-9993/006-102</b> pre-assembled interconnecting cable; Eca; Socket/plug; 3-pole; Cod. A; H05VV-F 3G 1.5 mm <sup>2</sup> ; 1 m; 1,50 mm <sup>2</sup> ; white	<a href="http://www.wago.com/771-9993/006-102">www.wago.com/771-9993/006-102</a>
	<b>Item no.771-9993/206-102</b> pre-assembled connecting cable; Eca; Plug/open-ended; 3-pole; Cod. A; H05VV-F 3G 1.5 mm <sup>2</sup> ; 1 m; 1,50 mm <sup>2</sup> ; white	<a href="http://www.wago.com/771-9993/206-102">www.wago.com/771-9993/206-102</a>

Subject to changes. Please also observe the further product documentation!

## Required accessories

### Cover

Cover		
	<b>Item no.: 770-201</b> Lockout cap; 12-pole, separable; for sockets; Plastic; black	<a href="http://www.wago.com/770-201">www.wago.com/770-201</a>
	<b>Item no.: 770-221</b> Lockout cap; 12-pole, separable; for sockets; Plastic; white	<a href="http://www.wago.com/770-221">www.wago.com/770-221</a>

## Downloads

### CAD/CAE-Data

#### CAD data

2D/3D Models 770-823	URL	Download

#### CAE data

EPLAN Data Portal 770-823	URL	Download

ZUKEN Portal 770-823	URL	Download

### PCB Design

Symbol and Footprint 770-823	URL	Download

CAX data for your PCB design, consisting of "schematic symbols and PCB footprints", allow easy integration of the WAGO component into your development environment.

### Supported formats:

- Accel EDA 14 & 15
- Altium 6 to current version
- Cadence Allegro
- DesignSpark
- Eagle Libraries
- KiCad
- Mentor Graphics BoardStation
- Mentor Graphics Design Architect
- Mentor Graphics Design Expedition 99 and 2000
- OrCAD 9.X PCB and Capture
- PADS PowerPCB 3, 3.5, 4.X, and 5.X

Subject to changes. Please also observe the further product documentation!



- PADS PowerPCB and PowerLogic 3.0
- PCAD 2000, 2001, 2002, 2004, and 2006
- Pulsonix 8.5 or newer
- STL
- 3D STEP
- TARGET 3001!
- View Logic ViewDraw
- Quadcept
- Zuken CadStar 3 and 4
- Zuken CR-5000 and CR-8000

PCB Component Libraries (EDA), PCB CAD Library Ultra Librarian

---

## Environmental Product Compliance

### Compliance Search

Environmental Product Compliance 770-823	URL	Download
Socket for PCBs; straight; 3-pole; Cod. A; white		

---

## Installation Notes

### Product family

**WINSTA® MIDI**  
[Show all products from the family](#)

Subject to changes. Please also observe the further product documentation!