

# **EBPC-3500**

**All-In-One, High Performance,  
Embedded Box PC chassis for  
3.5" Biscuit SBCs**

## **User Manual**

## Copyright

---

The documentation and the software included with this product are copyrighted 2007 by Advantech Co., Ltd. All rights are reserved. Advantech Co., Ltd. reserves the right to make improvements in the products described in this manual at any time without notice. No part of this manual may be reproduced, copied, translated or transmitted in any form or by any means without the prior written permission of Advantech Co., Ltd. Information provided in this manual is intended to be accurate and reliable. However, Advantech Co., Ltd. assumes no responsibility for its use, nor for any infringements of the rights of third parties, which may result from its use.

## Acknowledgements

---

Award is a trademark of Award Software International, Inc.

IBM, PC/AT, PS/2 and VGA are trademarks of International Business Machines Corporation.

Intel and Pentium are trademarks of Intel Corporation.

Microsoft Windows and MS-DOS are registered trademarks of Microsoft Corp.

RTL is a trademark of Realtek Semi-Conductor Co., Ltd.

All other product names or trademarks are properties of their respective owners.

For more information on this and other Advantech products, please visit our websites at: <http://www.advantech.com>

<http://www.advantech.com.tw/products>

[Sub\\_Category.asp?Category\\_ID=1-TPYQ7&BU=ACG&PD=EC](http://www.advantech.com.tw/products/Sub_Category.asp?Category_ID=1-TPYQ7&BU=ACG&PD=EC)

For technical support and service, please visit our support website at:

<http://support.advantech.com>

This manual is for the EBPC-3500.

Part No. 2006E35000

Printed in Taiwan

Edition 1

August 2007

## Product Warranty (2 years)

---

Advantech warrants to you, the original purchaser, that each of its products will be free from defects in materials and workmanship for two years from the date of purchase.

This warranty does not apply to any products which have been repaired or altered by persons other than repair personnel authorized by Advantech, or which have been subject to misuse, abuse, accident or improper installation. Advantech assumes no liability under the terms of this warranty as a consequence of such events.

Because of Advantech's high quality-control standards and rigorous testing, most of our customers never need to use our repair service. If an Advantech product is defective, it will be repaired or replaced at no charge during the warranty period. For out-of-warranty repairs, you will be billed according to the cost of replacement materials, service time and freight. Please consult your dealer for more details.

If you think you have a defective product, follow these steps:

1. Collect all the information about the problem encountered. (For example, CPU speed, Advantech products used, other hardware and software used, etc.) Note anything abnormal and list any onscreen messages you get when the problem occurs.
2. Call your dealer and describe the problem. Please have your manual, product, and any helpful information readily available.
3. If your product is diagnosed as defective, obtain an RMA (return merchandize authorization) number from your dealer. This allows us to process your return more quickly.
4. Carefully pack the defective product, a fully-completed Repair and Replacement Order Card and a photocopy proof of purchase date (such as your sales receipt) in a shippable container. A product returned without proof of the purchase date is not eligible for warranty service.
5. Write the RMA number visibly on the outside of the package and ship it prepaid to your dealer.

## Declaration of Conformity

---

### **CE**

This product has passed the CE test for environmental specifications when shielded cables are used for external wiring. We recommend the use of shielded cables. This kind of cable is available from Advantech. Please contact your local supplier for ordering information.

This product has passed the CE test for environmental specifications. Test conditions for passing included the equipment being operated within an industrial enclosure. In order to protect the product from being damaged by ESD (Electrostatic Discharge) and EMI leakage, we strongly recommend the use of CE-compliant industrial enclosure products.

### **FCC Class A**

Note: This equipment has been tested and found to comply with the limits for a Class A digital device, pursuant to part 15 of the FCC Rules. These limits are designed to provide reasonable protection against harmful interference when the equipment is operated in a commercial environment. This equipment generates, uses, and can radiate radio frequency energy and, if not installed and used in accordance with the instruction manual, may cause harmful interference to radio communications. Operation of this equipment in a residential area is likely to cause harmful interference in which case the user will be required to correct the interference at his own expense.

## Technical Support and Assistance

---

1. Visit the Advantech web site at **[www.advantech.com/support](http://www.advantech.com/support)** where you can find the latest information about the product.
2. Contact your distributor, sales representative, or Advantech's customer service center for technical support if you need additional assistance. Please have the following information ready before you call:
  - Product name and serial number
  - Description of your peripheral attachments
  - Description of your software (operating system, version, application software, etc.)
  - A complete description of the problem
  - The exact wording of any error messages

### EBPC-3500 Models

#### EBPC-3500 Model List

---

EBPC-3500-75SE: EBPC for PCM-9375E

---

EBPC-3500-75CE: EBPC, chassis kit for PCM-9375E

---

EBPC-3500-80SE: EBPC for PCM-9380F

---

EBPC-3500-80CE: EBPC, chassis kit for PCM-9380F & PCM-9386F

---

EBPC-3500-81SE: EBPC for PCM-9381F

---

EBPC-3500-81CE: EBPC, chassis kit for PCM-9381F & PCM-9387F

---

## Packing List

---

### EBPC-3500 packing list

Description	Q'tys
EBPC-3500 Unit*	1
PS2 Keyboard/Mouse Cable (P/N: 1700060202)	1
Driver and Utility CD for EBPC-3500 series V1.10 (P/N: 2066E35000)	1
2-P Phoenix to DC-Jack Power Cable (P/N: 1700001394)	1
Mounting bracket (P/N: 1960005758)	2

If any of these items are missing or damaged, contact your distributor or sales representative immediately.

\* Corresponding the ordering Part Number

## Safety Instructions

---

1. Please read these safety instructions carefully.
2. Please keep this User's Manual for later reference.
3. Please disconnect this equipment from AC outlet before cleaning. Don't use liquid or sprayed detergent for cleaning. Use moisture sheet or clothe for cleaning.
4. For pluggable equipment, the socket-outlet shall near the equipment and shall be easily accessible.
5. Please keep this equipment from humidity.
6. Lay this equipment on a reliable surface when install. A drop or fall could cause injury.
7. Do not leave this equipment in an uncontrolled environment; storage temperatures above 60°C may damage the equipment.
8. The openings on the enclosure are for air convection hence protecting the equipment from overheating. **DO NOT COVER THE OPENINGS.**
9. Make sure the voltage of the power source when connecting the equipment to the power outlet.
10. Place the power cord such a way that people cannot step on it. Do not place anything over the power cord. The power cord must be rated for the product and for the voltage and current marked on the product's electrical ratings label. The voltage and current rating of the cord should be greater than the voltage and current rating marked on the product.
11. All cautions and warnings on the equipment should be noted.
12. If the equipment is not used for long time, disconnect the equipment from mains to avoid being damaged by transient over-voltage.
13. Never pour any liquid into ventilation openings; this could cause fire or electrical shock.
14. Never open the equipment. For safety reasons, only qualified service personnel should open the equipment.
15. If one of the following situations arise, get the equipment checked by service personnel:
  - a The Power cord or plug is damaged.
  - b Liquid has penetrated the equipment.
  - c The equipment has been exposed to moisture.

- d The equipment has not worked well or you can not get it work according to user's manual.
  - e The equipment has been dropped and damaged.
  - f The equipment has obvious signs of breakage.
16. CAUTION: THIS COMPUTER IS PROVIDED WITH A BATTERY-POWERED REAL-TIME CLOCK CIRCUIT. THERE IS A DANGER OF EXPLOSION IF BATTERY IS INCORRECTLY REPLACED. REPLACE ONLY WITH SAME OR EQUIVLENT TYPE RECOMMENDED BY THE MANUFACTURE. DISCARD USED BATTERIES ACCORDING TO THE MANUFACTURER' S INSTRUCTIONS.

## Wichtige Sicherheitshinweise

---

1. Bitte lesen Sie sich diese Hinweise sorgfältig durch.
2. Heben Sie diese Anleitung für den späteren Gebrauch auf.
3. Vor jedem Reinigen ist das Gerät vom Stromnetz zu trennen. Verwenden Sie keine Flüssig- oder Aerosolreiniger. Am besten dient ein angefeuchtetes Tuch zur Reinigung.
4. Die Netzanschlusssteckdose soll nahe dem Gerät angebracht und leicht zugänglich sein.
5. Das Gerät ist vor Feuchtigkeit zu schützen.
6. Bei der Aufstellung des Gerätes ist auf sicheren Stand zu achten. Ein Kippen oder Fallen könnte Verletzungen hervorrufen.
7. Die Belüftungsöffnungen dienen zur Luftzirkulation, die das Gerät vor Überhitzung schützt. Sorgen Sie dafür, dass diese Öffnungen nicht abgedeckt werden.
8. Beachten Sie beim Anschluss an das Stromnetz die Anschlusswerte.
9. Verlegen Sie die Netzanschlussleitung so, dass niemand darüber fallen kann. Es sollte auch nichts auf der Leitung abgestellt werden.
10. Alle Hinweise und Warnungen, die sich an den Geräten befinden, sind zu beachten.
11. Wird das Gerät über einen längeren Zeitraum nicht benutzt, sollten Sie es vom Stromnetz trennen. Somit wird im Falle einer Überspannung eine Beschädigung vermieden.
12. Durch die Lüftungsöffnungen dürfen niemals Gegenstände oder Flüssigkeiten in das Gerät gelangen. Dies könnte einen Brand bzw. elektrischen Schlag auslösen.
13. Öffnen Sie niemals das Gerät. Das Gerät darf aus Gründen der elektrischen Sicherheit nur von autorisiertem Servicepersonal geöffnet werden.
14. Wenn folgende Situationen auftreten, ist das Gerät vom Stromnetz zu trennen und von einer qualifizierten Servicestelle zu überprüfen:
  - Netzkabel oder Netzstecker sind beschädigt.
  - Flüssigkeit ist in das Gerät eingedrungen.
  - Das Gerät war Feuchtigkeit ausgesetzt.
  - Wenn das Gerät nicht der Bedienungsanleitung entsprechend funktioniert oder Sie mit Hilfe dieser Anleitung keine Verbesserung erzielen.

- Das Gerät ist gefallen und/oder das Gehäuse ist beschädigt.
  - Wenn das Gerät deutliche Anzeichen eines Defektes aufweist.
15. **VORSICHT:** Explosionsgefahr bei unsachgemäßen Austausch der Batterie. Ersatz nur durch denselben oder einem vom Hersteller empfohlene-männlichen Typ. Entsorgung gebrauchter Batterien nach Angaben des Herstellers.
  16. **ACHTUNG:** Es besteht die Explosionsgefahr, falls die Batterie auf nicht fach-männische Weise gewechselt wird. Verfangen Sie die Batterie nur gleicher oder entsprechender Type, wie vom Hersteller empfohlen. Entsorgen Sie Batterien nach Anweisung des Herstellers.

Der arbeitsplatzbezogene Schalldruckpegel nach DIN 45 635 Teil 1000 beträgt 70dB(A) oder weniger.

Haftungsausschluss: Die Bedienungsanleitungen wurden entsprechend der IEC-704-1 erstellt. Advantech lehnt jegliche Verantwortung für die Richtigkeit der in diesem Zusammenhang getätigten Aussagen ab.

## **Safety Precaution - Static Electricity**

---

Follow these simple precautions to protect yourself from harm and the products from damage.

1. To avoid electrical shock, always disconnect the power from your PC chassis before you work on it. Don't touch any components on the CPU card or other cards while the PC is on.
2. Disconnect power before making any configuration changes. The sudden rush of power as you connect a jumper or install a card may damage sensitive electronic components.



# Contents

<b>Chapter 1</b>	<b>Overview .....</b>	<b>2</b>
1.1	Introduction .....	2
1.2	Features .....	2
1.2.1	Universal, Comprehensive and Flexible I/O Expansion Feature .....	2
1.2.2	Wide range of DC Power Inputs, ATX Supported .....	2
1.2.3	Compact, Robust Construction .....	2
1.2.4	Highly Scalable Performance with Low Power Consump- tion .....	3
1.2.5	Optimized Integration .....	3
1.3	Hardware Specification .....	3
1.3.1	Chassis Construction .....	3
1.3.2	Universal I/O ports .....	3
1.3.3	System Biscuit SBC board support .....	4
1.3.4	Drive Bay .....	6
1.3.5	Cooling System .....	6
1.3.6	Power Supply .....	6
1.3.7	Mechanical Specification .....	6
1.3.8	Environmental Specification .....	7
1.4	Chassis Dimension .....	8
	Figure 1.1 Chassis Dimension .....	8
<b>Chapter 2</b>	<b>Overview .....</b>	<b>10</b>
2.1	Introduction of External I/O Connectors of EBPC-3500- 75CE and EBPC-3500-75SE .....	10
	Figure 2.1 Front metal face plate external I/O connec- tors of EBPC-3500-75CE and EBPC- 3500-75SE .....	10
	Figure 2.2 Rear metal face plate I/O connectors of EBPC-3500-75CE/EBPC-3500-75SE ..	10
2.2	Introduction of External I/O Connectors of EBPC-3500- 80CE and EBPC-3500-80SE .....	11
	Figure 2.3 Front metal face plate external I/O connec- tors of EBPC-3500-80CE and EBPC- 3500-80SE .....	11
	Figure 2.4 Rear metal face plate I/O connectors of EBPC-3500-80CE/EBPC-3500-80SE ..	11
2.3	Introduction of External I/O Connectors of EBPC-3500- 81CE and EBPC-3500-81SE .....	12
	Figure 2.5 Front metal face plate external I/O connec- tors of EBPC-3500-81CE and EBPC-	

	3500-81SE.....	12
	Figure 2.6 Rear face plate I/O connectors for EBPC-3500-81CE/EBPC-3500-81SE.....	12
<b>Chapter 3</b>	<b>EBPC-3500 Internal Cable Arrangement and Connection .....</b>	<b>14</b>
3.1	System components placement of EBPC-3500.....	14
	Figure 3.1 EBPC-3500 system layout inside .....	14
3.2	EUIO-350 Pin-headers/Connectors placement .....	15
	Figure 3.2 EUIO-350 connectors.....	15
3.3	PCM-256 Pin-headers/Connectors placement .....	15
	Figure 3.3 PCM-256 connectors .....	15
3.4	PCM-257 Pin-headers/Connectors placement .....	16
	Figure 3.4 PCM-257 connectors .....	16
3.5	Internal cable corresponding connection table of EBPC-3500-75CE and EBPC-3500-75SE .....	17
	Table 3.1 EBPC-3500-75SE internal cables corresponding table .....	17
3.6	Internal cable corresponding connection table of EBPC-3500-80CE and EBPC-3500-80SE .....	20
	Table 3.2 EBPC-3500-80SE internal cables corresponding table .....	20
3.7	Internal cable corresponding connection table of EBPC-3500-81CE and EBPC-3500-81SE .....	23
	Table 3.3 EBPC-3500-81SE internal cables corresponding table .....	23
<b>Chapter 4</b>	<b>EBPC-3500 Hardware Installation.....</b>	<b>28</b>
4.1	Jumpers and Connectors.....	28
4.2	EUIO-350 Jumper setting (JP1/JP2) for COM2 RS-232/422/485.....	29
	Table 4.1 COM2 RS-232/422/485 Jumpers .....	29
	Figure 4.1 EUIO-350 JP1 and JP2 jumper setting for RS-232 .....	29
	Figure 4.2 EUIO-350 JP1 and JP2 jumper setting for RS-422/RS-485 .....	30
4.3	Installing the DDR SDRAM Memory Module .....	30
	Figure 4.3 Remove the four screw of HDD cover ...	31
	Figure 4.4 Plug the SDRAM into the RAM socket .	31
4.4	Inserting a Compact Flash Card .....	32
	Figure 4.5 Unscrew CF carrier from front plate .....	32
	Figure 4.6 Unscrew CF carrier from the front plate	33
	Figure 4.7 Put the CF card into the CF carrier.....	33
4.5	Installing the 2.5" Hard Disk Drive (HDD) .....	34
	Figure 4.8 Assemble the 3.5" HDD onto the HDD	

		Figure 4.9	Connect the IDE cable to the HDD connector	.....	35
		Figure 4.10	Remove the 3 screws before 2.5" HDD installation	.....	35
	4.6	Connecting Power	.....		36
<b>Chapter</b>	<b>5</b>	<b>System Disassembly Instruction</b>	.....		<b>38</b>
	5.1	Introduction	.....		38
		Figure 5.1	Unscrew top cover (right screw)	.....	38
		Figure 5.2	Unscrew the top cover (left screw)	.....	39
		Figure 5.3	Unscrew the top cover (bottom screws)	.....	39
		Figure 5.4	Remove the top cover	.....	40
		Figure 5.5	Remove the top cover	.....	40
		Figure 5.6	Remove the FAN module	.....	41
		Figure 5.7	Unscrew the Hex-bolts of the front cover (ex: EBPC-3500-80SE)	.....	41
		Figure 5.8	Unscrew Hex-bolts on rear cover	.....	42
		Figure 5.9	Remove fixing screws on the boards	.....	42
	5.2	Expansion IO plate assembly	.....		43
		Figure 5.10	Remove the expansion IO plate on the front panel	.....	43
		Figure 5.11	Remove the expansion IO plate on the rear side	.....	44



## Overview

This chapter gives background information on the EBPC-3500. It shows you the EBPC-3500 overview and specifications.

Sections include:

- Introduction
- Features
- Hardware Specifications
- Mechanical Specifications
- Chassis Dimension

# Chapter 1 Overview

## 1.1 Introduction

---

The EBPC-3500 series is a rugged and compact advanced Embedded Box PC Chassis kit system. It is designed specifically for 3.5-inch Biscuit Embedded SBC boards. With an easily customized design and front metal I/O faceplate, the unit can be equipped with various 3.5-inch biscuit boards.

## 1.2 Features

---

### 1.2.1 Universal, Comprehensive and Flexible I/O Expansion Feature

- Built-in universal I/O features that can carry all possible common I/O functional feature ports and external access from the chassis.
- Easy changeable and customizable front metal faceplate to suit various 3.5-inch biscuit SBC boards.
- Reserved space to expand the I/O by PC-104, PCI-104 or MIO interface card.
- Two dummy I/O plates allow customization for expanding additional I/O feature ports.

### 1.2.2 Wide range of DC Power Inputs, ATX Supported

- The EBPC-3500 series advanced Embedded PC system chassis allows for a wide range of power input from DC 12 V ~ 24 V, and it also supports ATX which offers system integrators the flexibility and excellent power management for various embedded application environments.

### 1.2.3 Compact, Robust Construction

- Robust, heavy-duty metal cast construction.
- Modularized design offers maximum space efficiency and good Electromagnetic Compatibility.
- A specially cushioned design that absorbs vibration of 2.5-inch HDD to ensure maximum reliability.

## 1.2.4 Highly Scalable Performance with Low Power Consumption

- Scalable Low Voltage and Ultra Low Voltage Pentium M class processor system to bring high computing performance with low power consumption.

## 1.2.5 Optimized Integration

- Simple and modularized service-friendly design
- Quick installation, easy expansion and maintenance
- Long Life cycle support for protecting continuity to secure investment.

# 1.3 Hardware Specification

---

## 1.3.1 Chassis Construction

- **Construction**  
Rugged and Compact Advanced Embedded Wall-Mountable PC system chassis.
- **Material**  
SECC, with painting.

## 1.3.2 Universal I/O ports

- **Parallel**  
1 \* rear-access LPT port by a DB-25 female connector
- **GPIO**  
1 \* rear-access GPIO port by a DB-15 female connector
- **COM**  
1 \* rear-access COM port by a DB-9 male connector
- **LAN**  
1 \* rear-access LAN port by a RJ-45 connector (EBPC-3500-75CE and EBPC-3500-75SE only, others are reserved)
- **USB**  
2 \* rear-access USB ports by a pair of double-stack mini-DIN connectors
- **Audio Line\_In**  
1 \* rear-access Line\_In port by a  $\Phi$  3.5 mm audio jack connector

- **Audio Mic\_In**  
1 \* rear-access Mic\_In port by a  $\Phi$  3.5 mm audio jack Connector
- **Audio Line\_Out**  
1 \* rear-access Line\_out port by a  $\Phi$  3.5 mm audio jack connector
- **LVDS**  
1 \* rear-access LVDS Port by DB-26 female Connector
- **Backlight**  
1 \* rear-access Backlight On/Off Control Port by DB-9 female Connector

### 1.3.3 System Biscuit SBC board support

- **EBPC-3500-75CE**

The EBPC-3500-75CE is the Embedded Box PC chassis kit specially designed for Advantech PCM-9375 series of Biscuit boards. Please refer to the User Manual file of PCM-9375 Biscuit board stored on the Driver and Utility CD Disk to learn more.

Please find the PDF file in the path of :

Driver Letter:

\\Appendix\Usr Manu\PCM-9375\_User\_Manual\_ed1.pdf from Driver& Utility CD Disk.

- **EBPC-3500-75SE**

EBPC-3500-75SE is an Embedded Box PC system with an Advantech PCM-9375E-J0A1E biscuit board inside. Please refer to the User Manual of PCM-9375 biscuit board on the Driver and Utility CD Disk to learn more.

Please find the PDF file in the path of :

Driver Letter:

\\Appendix\Usr Manu\PCM-9375\_User\_Manual\_ed1.pdf from Driver& Utility CD Disk.

- **EBPC-3500-80CE**

EBPC-3500-80CE is the Embedded Box PC chassis kit specially designed for Advantech's PCM-9380 biscuit boards. Please refer to the User Manual file of PCM-9380 biscuit board that stored on Driver and Utility CD Disk to learn more.

Please find the PDF file in the path of :

Driver Letter:

\\Appendix\Usr Manu\PCM-9380\_User\_Manual\_ed3.pdf from Driver& Utility CD Disk.

- **EBPC-3500-80SE**

EBPC-3500-80SE is an Embedded Box PC system with Advantech PCM-9380F-00A2E biscuit board inside. Please refer to the User Manual file of PCM-9380F biscuit board on the Driver and Utility CD Disk to learn more.

Please find the PDF file in the path of :

Driver Letter:

\\Appendix\Usr Manu\PCM-9380\_User\_Manual\_ed3.pdf from Driver& Utility CD Disk.

- **EBPC-3500-81CE**

EBPC-3500-81SE an Embedded Box PC chassis kit with Advantech's PCM-9381series of Biscuit board. Please refer to the User Manual file of PCM-9381 Biscuit board on the Driver and Utility CD Disk to learn more.

Please find the PDF file in the path of :

Driver Letter:

\\Appendix\Usr Manu\PCM-9381\_User\_Manual\_ed2.pdf from Driver& Utility CD Disk.

- **EBPC-3500-81SE**

EBPC-3500-81SE is an Embedded Box PC system with Advantech's PCM-9381F-00A2E Biscuit board inside. Please refer to the User Manual file of PCM-9381 Biscuit board on the Driver and Utility CD Disk to learn more.

Please find the PDF file in the path of :

Driver Letter:

\\Appendix\Usr Manu\PCM-9381\_User\_Manual\_ed2.pdf from Driver& Utility CD Disk.

### 1.3.4 Drive Bay

- **HDD Bay**  
1\* 2.5-inch drive space
- **CF Socket**  
Optional support for 1\* Compact Flash Socket from system SBC board

### 1.3.5 Cooling System

- **System FAN**  
1\* 40mm x 40mm x 20mm of VAPO-Bearing fan
- **Venting Hole**  
Located on top, left, right and rear for airflow convection.

### 1.3.6 Power Supply

- **Power Source**  
DC Input 12 V<sub>DC</sub> ~ 24 V<sub>DC</sub>
- **Power Input Connector**  
Front Access of 2-pole Phoenix type of DC power input connector; support input power source of 12 V<sub>DC</sub> ~ 24 V<sub>DC</sub> .
- **Input Voltage (Typical)**  
12 V<sub>DC</sub> @ 4.5 A, 16 V<sub>DC</sub> @ 3.4 A, 19 V<sub>DC</sub> @ 2.9 A, 24 V<sub>DC</sub> @ 2.3 A
- **Output Voltage**  
+5 V<sub>DC</sub> @ 7 A, +12 V<sub>DC</sub> @ 0.5 A, +5 VSB @ 1 A
- **Output Rating:** 46W
- **Power ON/OFF**  
One Power On/Off switch, ATX supported.

### 1.3.7 Mechanical Specification

- **Mounting**  
Supports Table Mount and Wall Mount.  
Built-in 1\*Wall Mount kit in accessory.
- **System Indicator**  
1\*Power on LED (Green)  
1\*HDD LED (Red)

- **Weight**  
Net 1.6 Kg for EBPC-3500-75CE, EBPC-3500-80CE, EBPC-3500-81CE  
Net 2.0 Kg for EBPC-3500-75SE, EBPC-3500-80SE, EBPC-3500-81SE
- **Dimension**  
Width: 230 mm / 9.05 inch  
Height: 70 mm / 2.75 inch  
Depth: 175 mm / 6.88 inch

### 1.3.8 Environmental Specification

- **Operation Temperature:** 0° C ~ 45° C
- **Relative Humidity:** 0% ~ 95% (none-condensing)
- **Vibration During Operation**  
1 Grms, IEC 60068-2-64, random, 5 ~ 500 Hz, 1 Oct./mm, 1hr/axis. X, Y, Z three axes
- **Shock During Operation**  
20G, IEC 60068-2-27, half-sine, 11ms duration
- **EMC Certification**  
Design to meet CE/FCC Class A
- **EMS Certification**  
Design to meet UL Certification.

## 1.4 Chassis Dimension

---

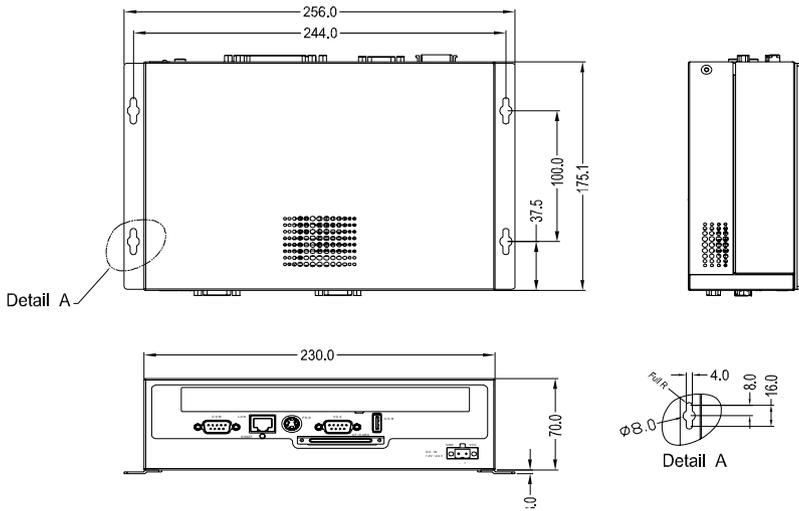

**Figure 1.1: Chassis Dimension**

## Overview

This chapter introduces EBPC-3500 external IO locations and internal daughter boards connector locations.

Sections include the introductions of Front and Rear External IO locations for:

- EBPC-3500-75CE, EBPC-3500-75CE
- EBPC-3500-80CE, EBPC-3500-80SE
- EBPC-3500-81CE, EBPC-3500-81SE

# Chapter 2 Overview

## 2.1 Introduction of External I/O Connectors of EBPC-3500-75CE and EBPC-3500-75SE

The following two figures show the external I/O connectors on EBPC-3500-75CE and EBPC-3500-75SE.

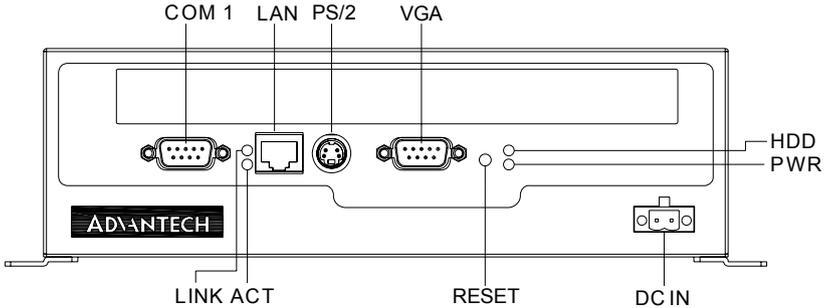

**Figure 2.1: Front metal face plate external I/O connectors of EBPC-3500-75CE and EBPC-3500-75SE**

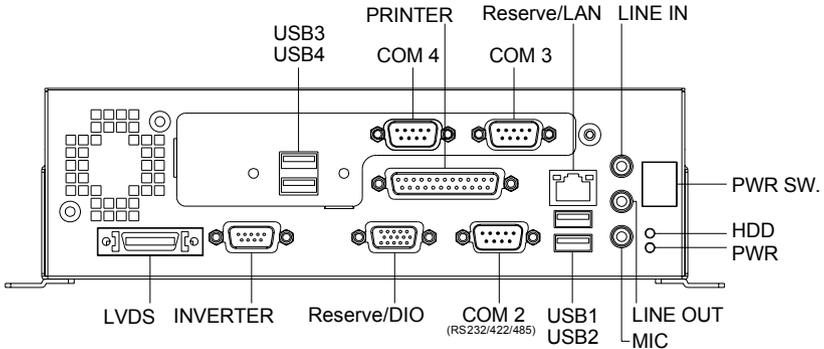

**Figure 2.2: Rear metal face plate I/O connectors of EBPC-3500-75CE/EBPC-3500-75SE**

## 2.2 Introduction of External I/O Connectors of EBPC-3500-80CE and EBPC-3500-80SE

The following two figures show the external I/O connectors on EBPC-3500-80CE and EBPC-3500-80SE.

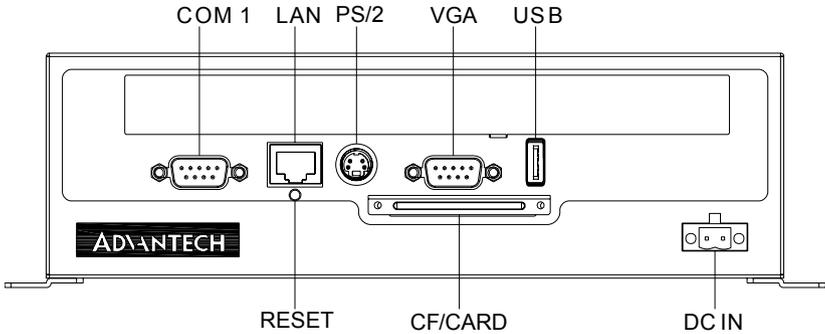

**Figure 2.3: Front metal face plate external I/O connectors of EBPC-3500-80CE and EBPC-3500-80SE**

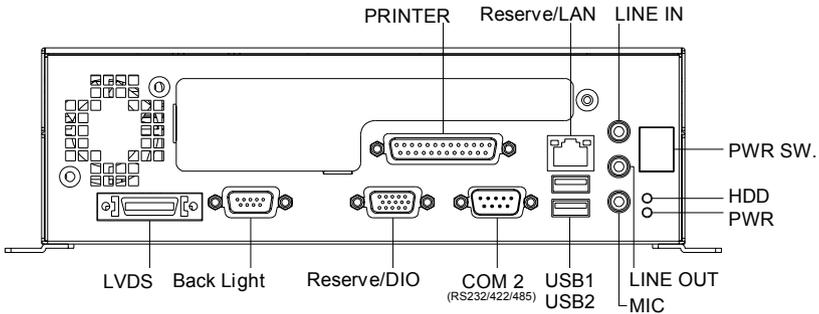

**Figure 2.4: Rear metal face plate I/O connectors of EBPC-3500-80CE/ EBPC-3500-80SE**

## 2.3 Introduction of External I/O Connectors of EBPC-3500-81CE and EBPC-3500-81SE

The following two figures show the external I/O connectors on EBPC-3500-81CE and EBPC-3500-81SE.

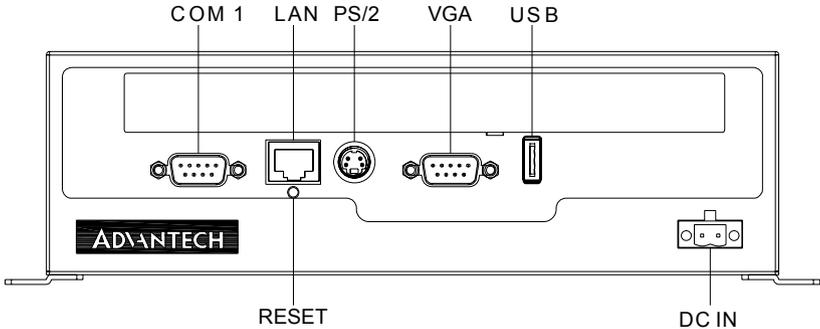

**Figure 2.5: Front metal face plate external I/O connectors of EBPC-3500-81CE and EBPC-3500-81SE**

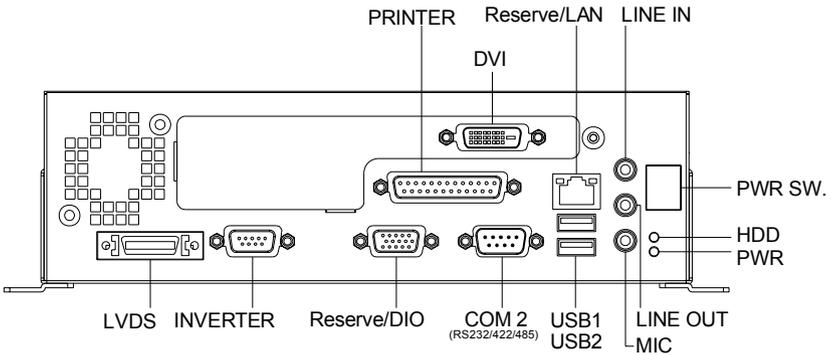

**Figure 2.6: Rear face plate I/O connectors for EBPC-3500-81CE/EBPC-3500-81SE**

## **EBPC-3500 Internal Cable Arrangement and Connection**

This chapter introduces EBPC-3500 internal cable connections for EBPC-3500 series models of:

- EBPC-3500-75CE, and EBPC-3500-75SE
- EBPC-3500-80CE, and EBPC-3500-80SE
- EBPC-3500-81CE, and EBPC-3500-81SE

# Chapter 3 EBPC-3500 Internal Cable Arrangement and Connection

## 3.1 System components placement of EBPC-3500

---

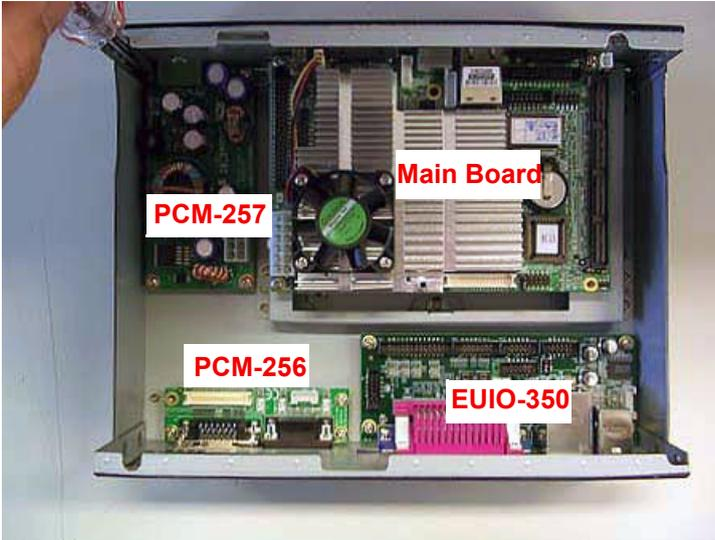

*Figure 3.1: EBPC-3500 system layout inside*

### 3.2 EUIO-350 Pin-headers/Connectors placement

---

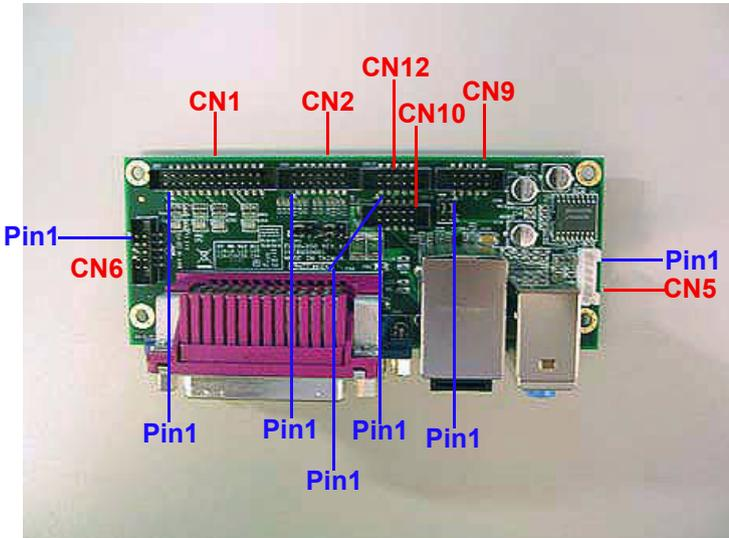

*Figure 3.2: EUIO-350 connectors*

### 3.3 PCM-256 Pin-headers/Connectors placement

---

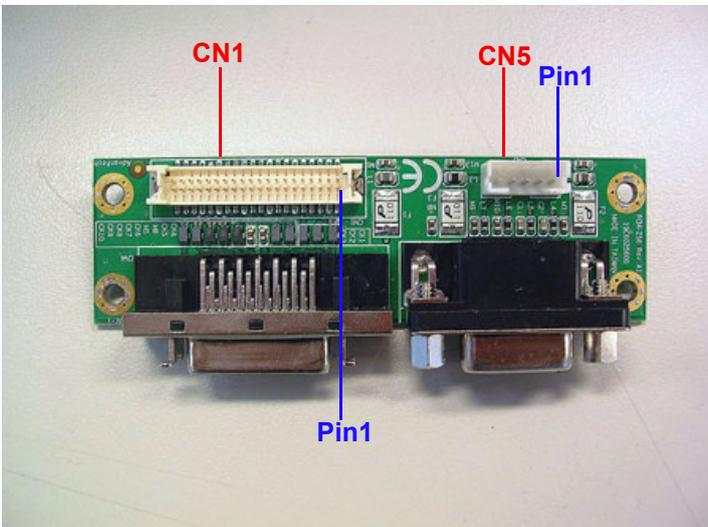

*Figure 3.3: PCM-256 connectors*

### 3.4 PCM-257 Pin-headers/Connectors placement

---

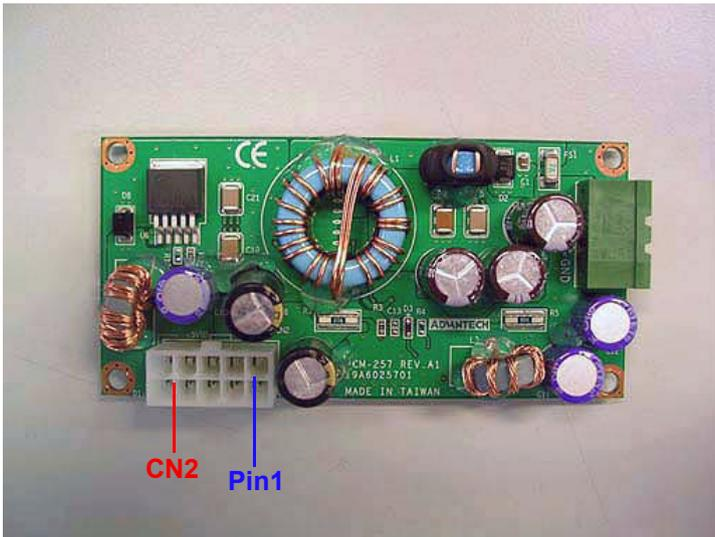

*Figure 3.4: PCM-257 connectors*

### 3.5 Internal cable corresponding connection table of EBPC-3500-75CE and EBPC-3500-75SE

**Table 3.1: EBPC-3500-75SE internal cables corresponding table**

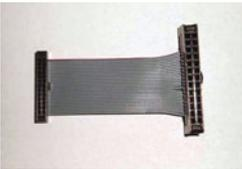
Part Number	From	To				Picture
	PCM-9375	PCM-256	PCM-257	EUIO-350	Others	
1700002283 Audio	CN22			CN9		
1700002276 USB 1,2	CN15			CN10		
1700002172 USB 3,4	CN13				Rear IO face-plate	
1700002285 COM	CN16			CN2		
1700002287 LPT Port	CN17			CN1		

**Table 3.1: EBPC-3500-75SE internal cables corresponding table**

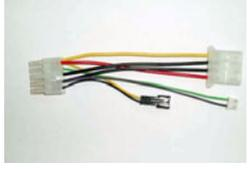
Part Number	From	To				Picture	
		PCM-9375	PCM-256	PCM-257	EUIO-350		Others
1700002295 DIO	CN9				CN6		
1700002286 Power	CN2 & CN1			CN3			
1700002281 HDD	CN11					Hard Disk	
1700002282 Inverter	CN5	CN5					
1700002297 LVDS	CN4	CN1					

**Table 3.1: EBPC-3500-75SE internal cables corresponding table**

Part Number	From	To				Picture	
		PCM-9375	PCM-256	PCM-257	EUIO-350		Others
1700001103 Switch	CN8					Switch	
1750000399 FAN						FAN	

### 3.6 Internal cable corresponding connection table of EBPC-3500-80CE and EBPC-3500-80SE

**Table 3.2: EBPC-3500-80SE internal cables corresponding table**

Part Number	From	To				Picture
	PCM-9380	PCM-256	PCM-257	EUIO-350	Others	
1700002274 LED Status	CN10			CN5		
1700002275 Audio	CN2			CN9		
1700002276 USB 2,3	CN5			CN10		
1700002277 COM2	CN8			CN2		
1700002278 LPT Port	CN13			CN1		

**Table 3.2: EBPC-3500-80SE internal cables corresponding table**

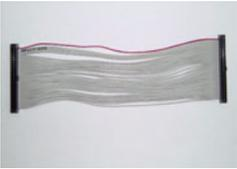
Part Number	From	To				Picture
	PCM-9380	PCM-256	PCM-257	EUIO-350	Others	
1700002279 DIO	CN7			CN6		
1700002280 Power	CN2		CN3			
1700002281 HDD	CN6				Hard Disk	
1700002288 Inverter	CN17	CN5				
1700002289 LVDS	CN1	CN1				

**Table 3.2: EBPC-3500-80SE internal cables corresponding table**

Part Number	From	To				Picture
	PCM-9380	PCM-256	PCM-257	EUIO-350	Others	
1700002294 Switch	CN16				Switch	
1750000399 FAN					FAN	

### 3.7 Internal cable corresponding connection table of EBPC-3500-81CE and EBPC-3500-81SE

**Table 3.3: EBPC-3500-81SE internal cables corresponding table**

Part Number	From	To				Picture
	PCM-9381	PCM-256	PCM-257	EUIO-350	Others	
1700002274 LED Status	CN10			CN5		
1700002275 Audio	CN2			CN9		
1700002276 USB 2,3	CN5			CN10		
1700002277 COM2	CN8			CN2		
1700002278 LPT Port	CN13			CN1		

**Table 3.3: EBPC-3500-81SE internal cables corresponding table**

Part Number	From	To				Picture
	PCM-9381	PCM-256	PCM-257	EUIO-350	Others	
1700000410 DVI	CN23				DVI	
1700002280 Power	CN2		CN3			
1700002281 HDD	CN6				Hard Disk	
1700002288 Inverter	CN17	CN5				
1700002289 LVDS	CN1	CN1				

**Table 3.3: EBPC-3500-81SE internal cables corresponding table**

Part Number	From	To				Picture	
	PCM-9381	PCM-256	PCM-257	EUIO-350	Others		
1700002294 Switch	CN16					Switch	
1750000399 FAN						FAN	



## EBPC-3500 Hardware Installation

This chapter introduces how to initialize the EBPC-3500.

Sections include:

- Jumpers and Connectors
- Installing the DDR SDRAM Memory Module
- Inserting a Compact Flash Card
- Installing the 2.5" Hard Disk Drive (HDD)
- Connecting Power

# Chapter 4 EBPC-3500 Hardware Installation

## 4.1 Jumpers and Connectors

---

The EBPC-3500 Embedded Box Computer consists of a PC-based computer that is housed in a metal chassis. Your HDD, SDRAM, are all readily accessible by removing the accessed HDD cover from the bottom. Any maintenance or hardware upgrades can be easily completed after removing the top cover, front and rear face plate. If you are a system integrator and need to know how to completely disassemble the embedded box computer, you can find more useful information in Chapter 5.



*Warning! Do not remove any mechanical parts, such as the top cover, bottom cover and front with rear face plate until you have verified that no power is flowing within the Embedded Box Computer. Power must be switched off and the power cord must be unplugged. Every time you service the Embedded Box Computer, you should be aware of this.*

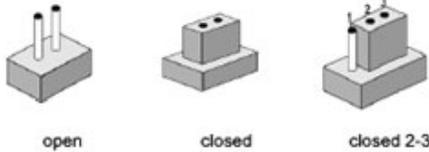

The jumper settings are schematically depicted in this manual as follows:

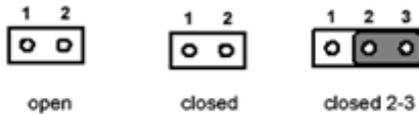

A pair of needle-nose pliers may be helpful when working with jumpers. If you have any doubts about the best hardware configuration for your application, contact your local distributor or sales representative before you make any changes.

## 4.2 EUIO-350 Jumper setting (JP1/JP2) for COM2 RS-232/422/485

The COM2 port located on EBPC-3500 rear metal face plate can be configured to operate in RS-232, RS-422 or RS-485 mode. It is not only setting on the M/B but also the EUIO-350 need be setting up the Jumper JP1 and JP2 located on it. (Please see PCM user manual for M/B setting.)

**Table 4.1: COM2 RS-232/422/485 Jumpers**

Function	Setting
RS-232*	JP1 and JP2 (1-2 closed)
RS-422	JP1 and JP2 (2-3 closed)
RS-485	JP1 and JP2 (2-3 closed)

(\*): means default setting of the jumper/function

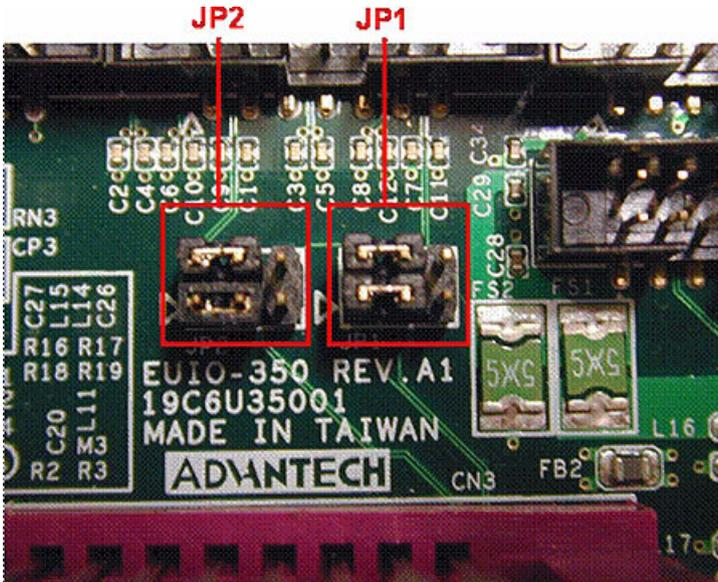

**Figure 4.1: EUIO-350 JP1 and JP2 jumper setting for RS-232**

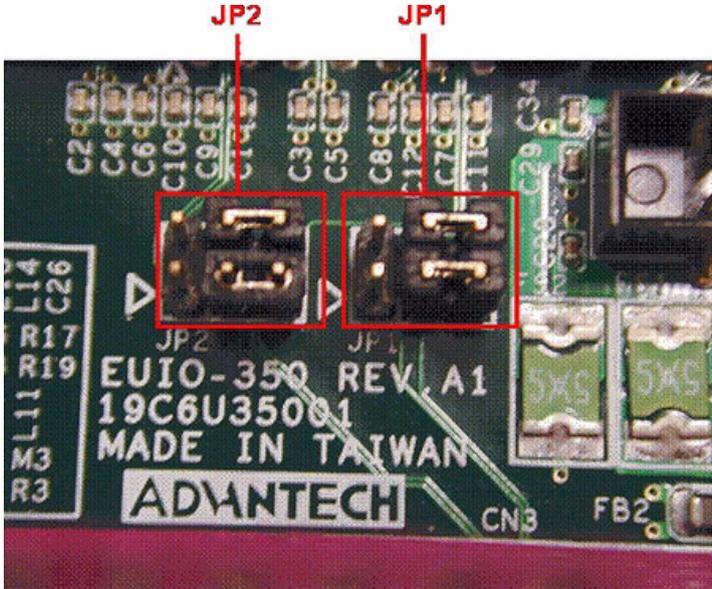

*Figure 4.2: EUIO-350 JP1 and JP2 jumper setting for RS-422/RS-485*

### **4.3 Installing the DDR SDRAM Memory Module**

---

EBPC-3500 provides one 200-pin SODIMM socket and supports 2.5 V DDR SDRAM. You can install from 64 MB to 1 GB of DDR SDRAM memory. The procedure for installing a DDR SDRAM SODIMM into the EBPC-3500 is detailed below, please follow these steps carefully.

1. Remove the power cord.
2. Unscrew the HDD cover screws and remove the HDD cover.

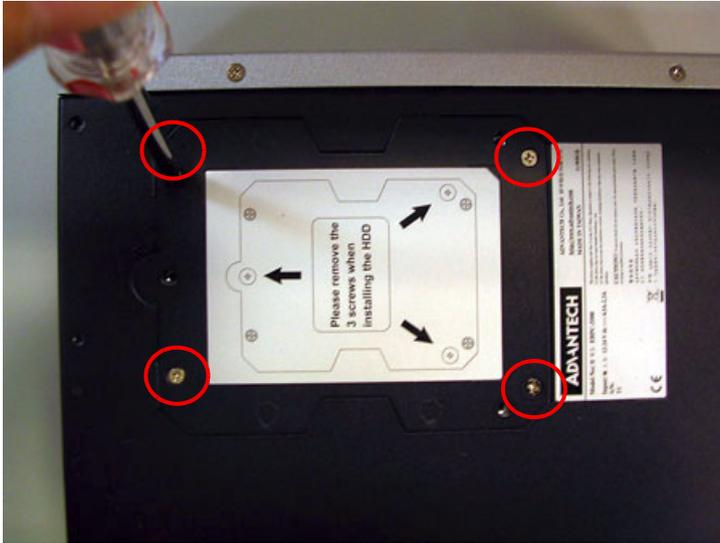

**Figure 4.3: Remove the four screw of HDD cover**

3. Plug a DDR SDRAM into the DDR SDRAM SODIMM socket on the motherboard.

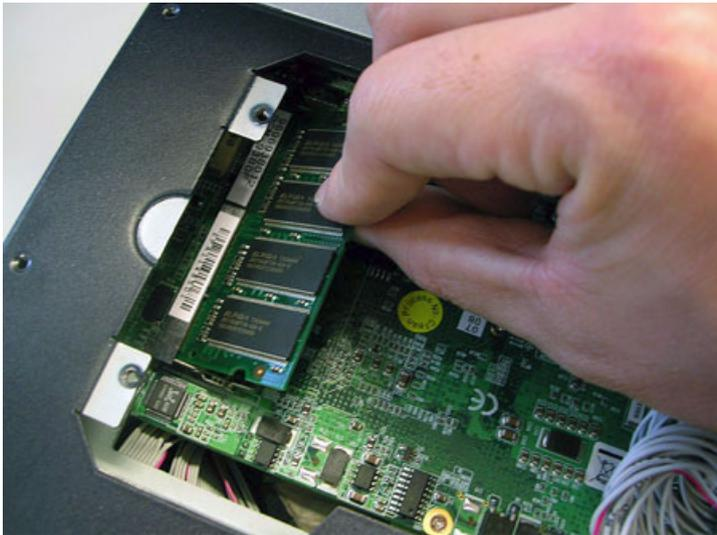

**Figure 4.4: Plug the SDRAM into the RAM socket**

4. Screw back the HDD cover with four screws.

## 4.4 Inserting a Compact Flash Card

---

The procedure for installing a Compact Flash card into the EBPC-3500 (for models of EBPC-3500-80SE and EBPC-3500-80CE only) is detailed below, please follow these steps carefully.

1. Remove the power cord.
2. Unscrew the two screws from the CF Door on the front plate.



*Figure 4.5: Unscrew CF carrier from front plate*

3. Remove the CF carrier.



*Figure 4.6: Unscrew CF carrier from the front plate*

4. Remove the dummy CF card from the CF carrier.

5. Put the CF card into the CF carrier.

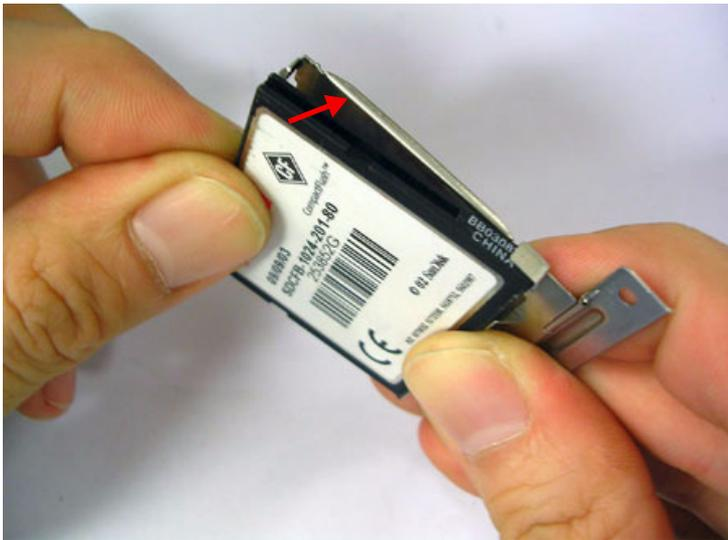

*Figure 4.7: Put the CF card into the CF carrier*

6. Insert the CF carrier back and assemble with 2 screws onto the front plate.

**Note:** The CompactFlash socket is allocated as Secondary IDE Master.

## 4.5 Installing the 2.5" Hard Disk Drive (HDD)

---

You can attach one enhanced Integrated Device Electronics (IDE) hard disk drive to EBPC-3500's internal controller which uses a PCI local-bus interface. The advanced IDE controller supports faster data transfer and allows the IDE hard drive to exceed 528 MB. The following are instructions for installation:

1. Remove the power cord.
2. Unscrew the HDD cover screws and remove the HDD cover.  
(See Fig. 4.3)\*
3. Assemble the 3.5" HDD onto the HDD bracket by 4 screws.

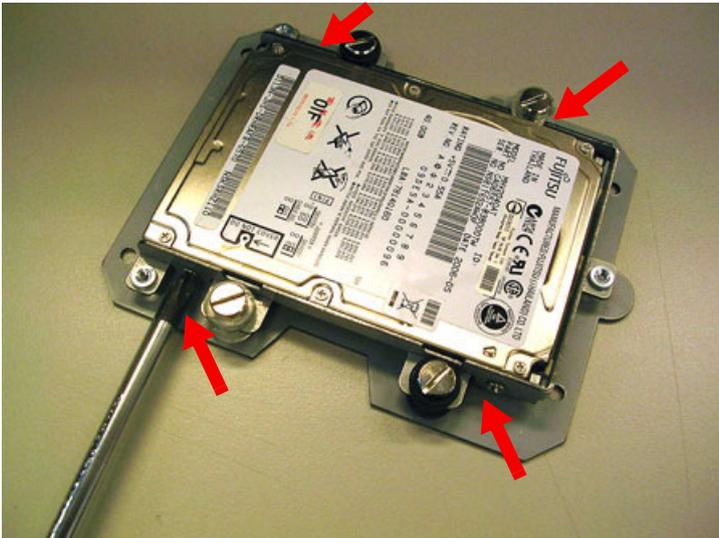

*Figure 4.8: Assemble the 3.5" HDD onto the HDD bracket*

4. Connect the IDE flat cable to the connector to the hard disk. (Treat it carefully. Don't make the wrong side of the IDE cable connection.)



**Figure 4.9: Connect the IDE cable to the HDD connector**

5. Screw back the bottom cover with the four screws.

\* Note: Before installing the 2.5" HDD, there are 3 anti-vibration fixing screws that should be removed first. Please see picture below.

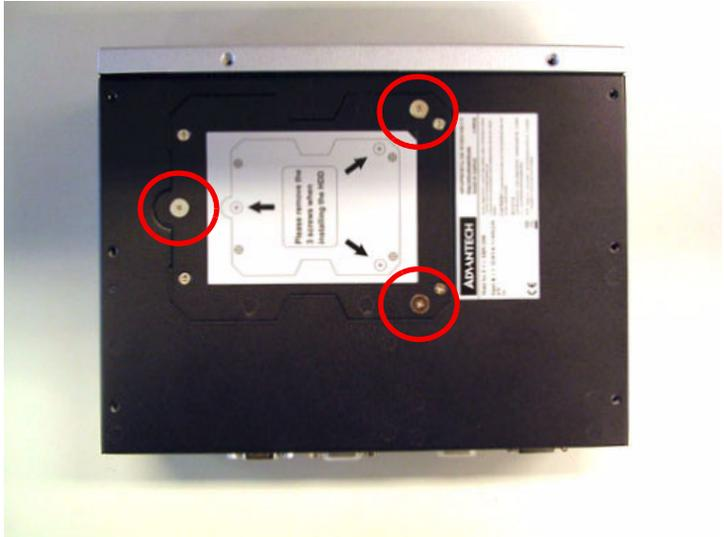

**Figure 4.10: Remove the 3 screws before 2.5" HDD installation**

## 4.6 Connecting Power

---

Connect the EBPC-3500 to a 12~24 VDC power source. The power source can either be from a power adapter or an in-house power source.

# CHAPTER 5

## **System Disassembly Instruction**

This chapter shows how to disassemble EBPC-3500. It is easy for system integrator to maintain.

# Chapter 5 System Disassembly Instruction

## 5.1 Introduction

---

If you want to completely disassemble the EBPC-3500 embedded box computer, follow the step-by-step procedures below. Users should be aware that Advantech Co., Ltd. takes no responsibility whatsoever for any problems or damage caused by the user disassembly of the EBPC-3500 embedded box computer. Make sure the power cord of the EBPC-3500 embedded box computer is unplugged before you start disassembly. The following procedures do not include the detailed disassembly procedures for the HDD, Compact Flash Disk and DRAM; all of which can be found in Chapter 3.

1. Unscrew the top cover and remove it.



*Figure 5.1: Unscrew top cover (right screw)*

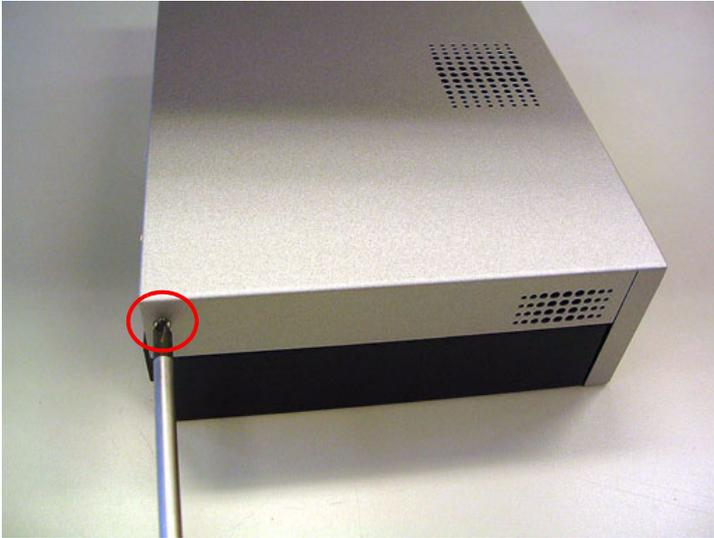

*Figure 5.2: Unscrew the top cover (left screw)*

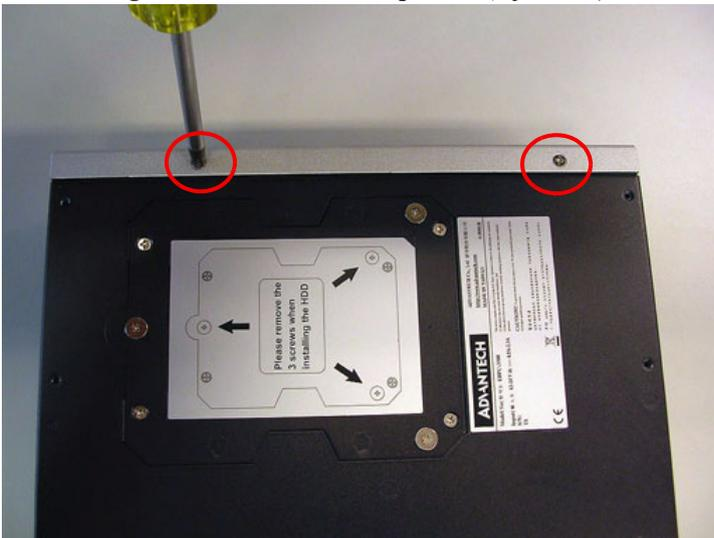
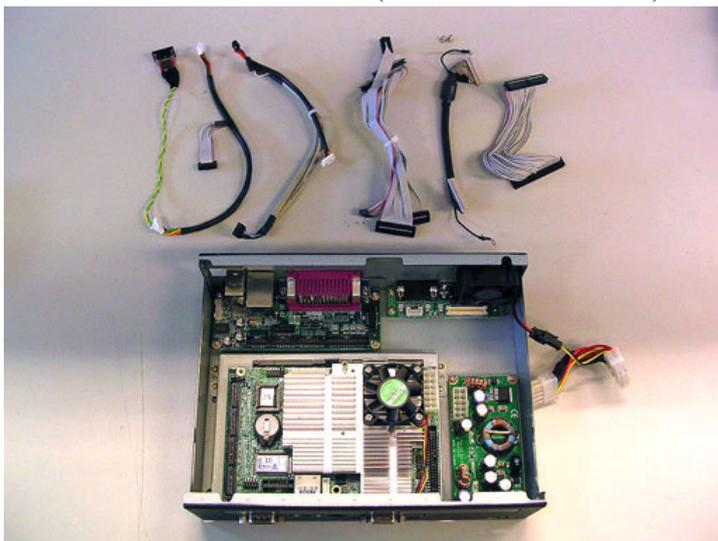

*Figure 5.3: Unscrew the top cover (bottom screws)*



**Figure 5.4: Remove the top cover.**

2. Disconnect all the cables inside. (Besides the FAN module).



**Figure 5.5: Remove the top cover**

3. Remove the HDD module and CF card carrier. (Please see 4.3 ~ 4.5)

4. Remove the FAN module.



*Figure 5.6: Remove the FAN module*

5. Unscrew the Hex-bolts of the front cover.



*Figure 5.7: Unscrew the Hex-bolts of the front cover (ex: EBPC-3500-80SE)*

6. Unscrew the Hex-bolts of the rear cover.



*Figure 5.8: Unscrew Hex-bolts on rear cover*

7. Remove all the fixing screws of the boards.

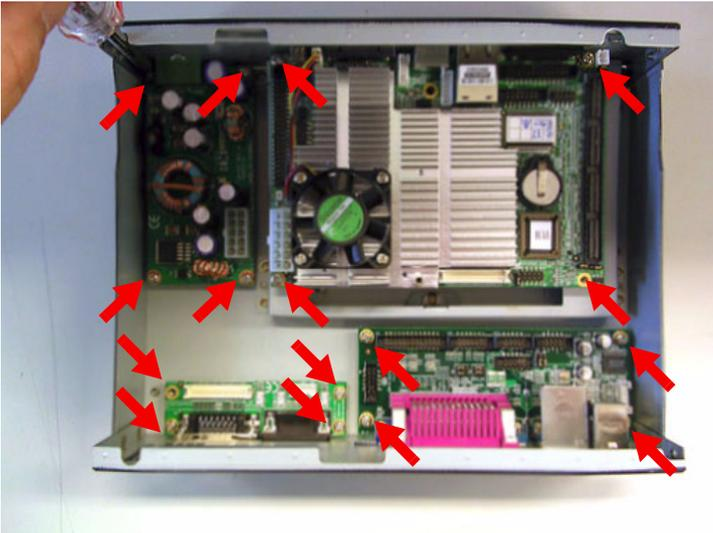

*Figure 5.9: Remove fixing screws on the boards*

## 5.2 Expansion IO plate assembly

---

The above-mentioned instructions are enough to guide a user to assemble (disassemble) EBPC-3500. In the following steps are for the application when user adding the MIO module (PC 104 module) or other expansions and need to remove the front IO window and the rear IO window.

1. Remove the expansion IO plate on the front panel.

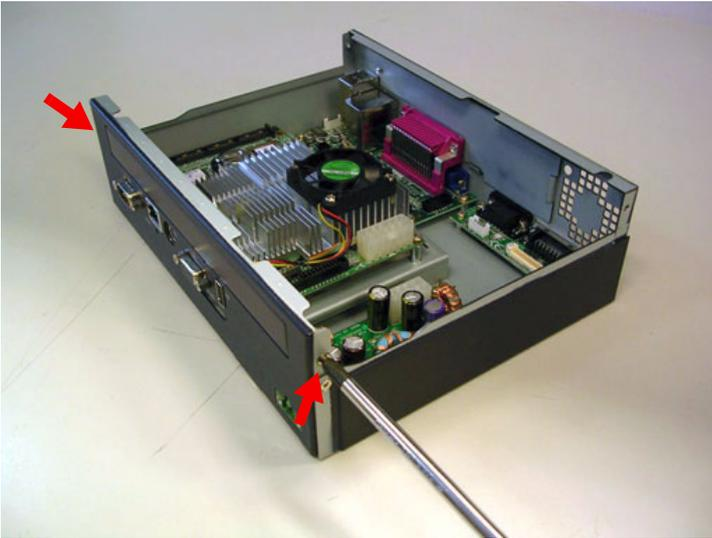

*Figure 5.10: Remove the expansion IO plate on the front panel*

2. Remove the expansion IO plate on the rear side.



*Figure 5.11: Remove the expansion IO plate on the rear side*