

Type 1XL Wi-Fi® + Bluetooth® Module

NXP 88W9098 Chipset for 802.11 a/b/g/n/ac/ax 2x2 MIMO +
Bluetooth 5.3 Datasheet - Rev. M

- Design Name: Type 1XL
- P/N: LBEE5ZZ1XL-774



Table of Contents

1 Scope	8
2 Key Features	8
3 Ordering Information	8
4 Block Diagram	9
5 Certification Information	10
5.1 Radio Certification.....	10
5.2 Bluetooth Qualification	10
6 Dimensions, Markings and Terminal Configurations	11
7 Module Pin Descriptions	12
7.1 Pin Assignments	12
7.2 Pin Descriptions	14
7.3 Configuration Pins.....	18
7.4 Pin States	18
7.5 SDIO Pin Descriptions	20
8 Absolute Maximum Ratings	21
9 Operating Condition	22
9.1 Operating Condition	22
9.2 Digital I/O Requirements	22
9.3 Package Thermal Conditions	22
10 Power Sequence	23
10.1 Power-On Sequence.....	23
10.1.1 Power-On Sequence for 3.3V.....	23
10.1.2 Power-On Sequence for 1.8V.....	24
10.2 Power-Off Sequence.....	24
11 Host Interface Specification	25
11.1 SDIO Specifications	25
11.1.1 Default Speed, High Speed Modes.....	25
11.1.2 SDR12, SDR25, SDR50 Modes up to 100 MHz (1.8V).....	27
11.1.3 SDR104 Mode at 208 MHz (1.8V)	28
11.1.4 DDR50 Mode at 50 MHz (1.8V)	29
11.2 PCI Express Specifications	31
11.2.1 Differential Tx Output Electricals.....	31
11.2.2 Differential Rx Input Electricals	34
12 DC/RF Characteristics	36
12.1 DC/RF Characteristics for IEEE 802.11b - 2.4 GHz.....	36

12.1.1 High-Rate Condition for IEEE 802.11b - 2.4 GHz	37
12.1.2 Low-Rate Condition for IEEE 802.11b - 2.4 GHz	38
12.2 DC/RF Characteristics for IEEE 802.11g - 2.4 GHz.....	39
12.2.1 High-Rate Condition for IEEE 802.11g - 2.4 GHz	39
12.2.2 Low-Rate Condition for IEEE 802.11g - 2.4 GHz	40
12.3 DC/RF Characteristics for IEEE 802.11n - 2.4 GHz.....	41
12.3.1 High-Rate Condition for IEEE 802.11n - 2.4 GHz	41
12.3.2 Low-Rate Condition for IEEE 802.11n - 2.4 GHz	42
12.4 DC/RF Characteristics for IEEE 802.11ax - 2.4 GHz.....	43
12.4.1 High-Rate Condition for IEEE 802.11ax - 2.4 GHz	43
12.4.2 Low-Rate Condition for IEEE 802.11ax - 2.4 GHz	44
12.5 DC/RF Characteristics for IEEE 802.11a - 5 GHz.....	45
12.5.1 High-Rate Condition for IEEE 802.11a - 5 GHz	45
12.5.2 Low-Rate Condition for IEEE 802.11a - 5 GHz	46
12.6 DC/RF Characteristics for IEEE 802.11n (HT20) - 5 GHz.....	47
12.6.1 High-Rate Condition for IEEE 802.11n (HT20) - 5 GHz	47
12.6.2 Low-Rate Condition for IEEE 802.11n (HT20) - 5 GHz	48
12.7 DC/RF Characteristics for IEEE 802.11ac (VHT20) - 5 GHz	49
12.7.1 High-Rate Condition for IEEE 802.11ac (VHT20) - 5 GHz	49
12.7.2 Low-Rate Condition for IEEE 802.11ac (VHT20) - 5 GHz	50
12.8 DC/RF Characteristics for IEEE 802.11n (HT40) - 5 GHz.....	52
12.8.1 High-Rate Condition for IEEE 802.11n (HT40) - 5 GHz	52
12.8.2 Low-Rate Condition for IEEE 802.11n (HT40) - 5 GHz	53
12.9 DC/RF Characteristics for IEEE 802.11ac (VHT40) - 5 GHz	54
12.9.1 High-Rate Condition for IEEE 802.11ac (VHT40) - 5 GHz	54
12.9.2 Low-Rate Condition for IEEE 802.11ac (VHT40) - 5 GHz	55
12.10 DC/RF Characteristics for IEEE 802.11ac (VHT80) - 5 GHz.....	56
12.10.1 High-Rate Condition for IEEE 802.11ac (VHT80) - 5 GHz	56
12.10.2 Low-Rate Condition for IEEE 802.11ac (VHT80) - 5 GHz	57
12.11 DC/RF Characteristics for IEEE 802.11ax (HE20) - 5 GHz.....	58
12.11.1 High-Rate Condition for IEEE 802.11ax (HE20) - 5 GHz	59
12.11.2 Low-Rate Condition for IEEE 802.11ax (HE20) - 5 GHz	60
12.12 DC/RF Characteristics for IEEE 802.11ax (HE40) - 5 GHz.....	61
12.12.1 High-Rate Condition for IEEE 802.11ax (HE40) - 5 GHz	61
12.12.2 Low-Rate Condition for IEEE 802.11ax (HE40) - 5 GHz	62
12.13 DC/RF Characteristics for IEEE 802.11ax (HE80) - 5 GHz.....	63
12.13.1 High-Rate Condition for IEEE 802.11ax (HE80) - 5 GHz	63

12.13.2 Low-Rate Condition for IEEE 802.11ax (HE80) - 5 GHz	65
12.14 DC/RF Characteristics for Bluetooth.....	66
12.14.1 Basic Data Rate Condition.....	66
12.14.2 Enhanced Data Rate Condition	67
12.15 DC/RF Characteristics for Bluetooth Low Energy	68
12.15.1 1 Mbps PHY Condition	68
12.15.2 2 Mbps PHY Condition	69
13 Land Patterns	71
14 Tape and Reel Packing.....	72
14.1 Dimensions of Tape (Plastic Tape).....	72
14.2 Dimensions of Reel	73
14.3 Taping Diagrams.....	74
14.4 Leader and Tail Tape	75
14.5 Packaging (Humidity Proof Packing)	76
15 Notice	77
15.1 Storage Conditions.....	77
15.2 Handling Conditions	77
15.3 Standard PCB Design (Land Pattern and Dimensions)	77
15.4 Notice for Chip Placer	78
15.5 Soldering Conditions	78
15.6 Cleaning.....	78
15.7 Operational Environment Conditions	78
16 Precondition to Use Our Products.....	80
Revision History.....	82

Figures

Figure 1: Block Diagram	9
Figure 2: Dimensions, Marking and Terminal Configurations	11
Figure 3: Structure	12
Figure 4: Pin Assignments Top View	13
Figure 5: SDIO Modes	21
Figure 6: Package Thermal Conditions	23
Figure 7: Power-On Sequence Graph for VIO 3.3V	23
Figure 8: Power-On Sequence Graph for VIO 1.8V	24
Figure 9: Power-Off Sequence Graph.....	24
Figure 10: SDIO Protocol Timing Diagram - Default Speed Mode (3.3V)	25
Figure 11: SDIO Protocol Timing Diagram - High Speed Mode (3.3V)	26

Figure 12: SDIO Protocol Timing Diagram - SDR12, SDR25, SDR50 Modes	27
Figure 13: SDIO Protocol Timing Diagram - SDR104 Mode.....	28
Figure 14: SDIO CMD Timing Diagram - DDR50 Mode	29
Figure 15: SDIO DAT[3:0] Timing Diagram - DDR50 Mode	29
Figure 16: Burst Current Definition.....	36
Figure 17: Land Patterns (Unit: mm).....	71
Figure 18: Dimensions of Tape (Plastic Tape)	72
Figure 19: Dimensions of Reel (Unit: mm)	73
Figure 20: Taping Diagrams.....	74
Figure 21: Leader and Tail Tape.....	75
Figure 22: Peeling Force.....	76
Figure 23: Humidity Proof Packing.....	76
Figure 24: Reflow Soldering Standard Conditions (Example).....	78

Tables

Table 1: Document Conventions.....	7
Table 2: Ordering Information	8
Table 3: Radio Certification.....	10
Table 4: Markings	11
Table 5: Dimensions	12
Table 6: Terminal Configurations	13
Table 7: Pin Descriptions	14
Table 8: Configuration Pins.....	18
Table 9: I/O State Table.....	19
Table 10: SDIO Pin Descriptions	20
Table 11: Absolute Maximum Ratings.....	21
Table 12: Operating Conditions	22
Table 13: Digital I/O Requirements Parameters	22
Table 14: SDIO Timing Data - Default Speed, High Speed Modes (3.3V).....	26
Table 15: SDIO Timing Data - SDR12, SDR25, SDR50 Modes	27
Table 16: SDIO Timing Data - SDR104 Mode.....	28
Table 17: SDIO Timing Data - DDR50 Mode	29
Table 18: PCI Express Tx Output Specifications Data - 2.5 GT/s.....	31
Table 19: PCI Express Tx Output Specifications Data - 5 GT/s.....	32
Table 20: PCI Express Rx Input Specifications Data - 2.5 GT/s	34
Table 21: PCI Express Rx Input Specifications Data - 5 GT/s.....	35
Table 22: DC/RF Characteristic Files.....	36
Table 23: DC/RF Characteristics for IEEE 802.11b - 2.4 GHz.....	36
Table 24: High-Rate Condition for IEEE 802.11b - 2.4 GHz.....	37

Table 25: Low-Rate Condition for IEEE 802.11b - 2.4 GHz.....	38
Table 26: DC/RF Characteristics for IEEE 802.11g - 2.4 GHz.....	39
Table 27: High-Rate Condition for IEEE 802.11g - 2.4 GHz.....	39
Table 28: Low-Rate Condition for IEEE 802.11g - 2.4 GHz.....	40
Table 29: DC/RF Characteristics for IEEE 802.11n - 2.4 GHz.....	41
Table 30: High-Rate Condition for IEEE 802.11n - 2.4 GHz.....	41
Table 31: Low-Rate Condition for IEEE 802.11n - 2.4 GHz.....	42
Table 32: DC/RF Characteristics for IEEE 802.11ax - 2.4 GHz.....	43
Table 33: High-Rate Condition for IEEE 802.11ax - 2.4 GHz.....	43
Table 34: Low-Rate Condition for IEEE 802.11ax - 2.4 GHz.....	44
Table 35: DC/RF Characteristics for IEEE 802.11a - 5 GHz.....	45
Table 36: High-Rate Condition for IEEE 802.11a - 5 GHz.....	45
Table 37: Low-Rate Condition for IEEE 802.11a - 5 GHz.....	46
Table 38: DC/RF Characteristics for IEEE 802.11n(HT20) - 5 GHz.....	47
Table 39: High-Rate Condition for IEEE 802.11n (HT20) - 5 GHz.....	47
Table 40: Low-Rate Condition for IEEE 802.11n (HT20) - 5 GHz.....	48
Table 41: DC/RF Characteristics for IEEE 802.11ac (VHT20) - 5 GHz.....	49
Table 42: High-Rate Condition for IEEE 802.11ac (VHT20) - 5 GHz.....	49
Table 43: Low-Rate Condition for IEEE 802.11ac (VHT20) - 5 GHz.....	50
Table 44: DC/RF Characteristics for IEEE 802.11n (HT40) - 5 GHz.....	52
Table 45: High-Rate Condition for IEEE 802.11n (HT40) - 5 GHz.....	52
Table 46: Low-Rate Condition for IEEE 802.11n (HT40) - 5 GHz.....	53
Table 47: DC/RF Characteristics for IEEE 802.11ac (VHT40) - 5 GHz.....	54
Table 48: High-Rate Condition for IEEE 802.11ac (VHT40) - 5 GHz.....	54
Table 49: Low-Rate Condition for IEEE 802.11ac (VHT40) - 5 GHz.....	55
Table 50: DC/RF Characteristics for IEEE 802.11ac (VHT80) - 5 GHz.....	56
Table 51: High-Rate Condition for IEEE 802.11ac (VHT80) - 5 GHz.....	56
Table 52: Low-Rate Condition for IEEE 802.11ac (VHT80) - 5 GHz.....	57
Table 53: DC/RF Characteristics for IEEE 802.11ax (HE20) - 5 GHz.....	58
Table 54: High-Rate Condition for IEEE 802.11ax (HE20) - 5 GHz.....	59
Table 55: Low-Rate Condition for IEEE 802.11ax (HE20) - 5 GHz.....	60
Table 56: DC/RF Characteristics for IEEE 802.11ax (HE40) - 5 GHz.....	61
Table 57: High-Rate Condition for IEEE 802.11ax (HE40) - 5 GHz.....	61
Table 58: Low-Rate Condition for IEEE 802.11ax (HE 40) - 5 GHz.....	62
Table 59: DC/RF Characteristics for IEEE 802.11ax (HE80) - 5 GHz.....	63
Table 60: High-Rate Condition for IEEE 802.11ax (HE80) - 5 GHz.....	63
Table 61: Low-Rate Condition for IEEE 802.11ax (HE80) - 5 GHz.....	65
Table 62: Basic Data Rate Condition.....	66
Table 63: Enhanced Data Rate Condition.....	67
Table 64: 1 Mbps PHY Condition.....	68

Table 65: 2 Mbps PHY Condition69
Table 66: Taping Specifications74

About This Document

Murata's Type 1XL is a small and high-performance module based on NXP 88W9098 combo chipset, supporting IEEE 802.11a/b/g/n/ac/ax 2x2 MIMO + Bluetooth 5.3 BR/EDR/LE. This datasheet describes Type 1XL module in detail.



Please be aware that an important notice concerning availability, standard warranty and use in critical applications of Murata products and disclaimers thereto appears at the end of this specification sheet.









Audience & Purpose

Intended audience includes any customer looking to integrate this module into their product. In particular RF, hardware, software, and systems engineers.

Document Conventions

Table 1 describes the document conventions.

Table 1: Document Conventions

Conventions	Description
	Warning Note Indicates very important note. Users are strongly recommended to review.
	Info Note Intended for informational purposes. Users should review.
	Menu Reference Indicates menu navigation instructions. Example: Insert → Tables → Quick Tables → Save Selection to Gallery 
	External Hyperlink This symbol indicates a hyperlink to an external document or website. Example: Embedded Artists AB  Click on the text to open the external link.
	Internal Hyperlink This symbol indicates a hyperlink within the document. Example: Scope  Click on the text to open the link.
<code>Console input/output or code snippet</code>	Console I/O or Code Snippet This text <i>Style</i> denotes console input/output or a code snippet.
<code># Console I/O comment // Code snippet comment</code>	Console I/O or Code Snippet Comment This text <i>Style</i> denotes a console input/output or code snippet comment. <ul style="list-style-type: none"> • Console I/O comment (preceded by "#") is for informational purposes only and does not denote actual console input/output. • Code Snippet comment (preceded by "//") may exist in the original code.

1 Scope

This specification characterizes the IEEE 802.11 a/b/g/n/ac/ax 2x2 MIMO + Bluetooth 5.3 combo BR/EDR/LE module.

2 Key Features

- NXP 88W9098 inside
- Supports IEEE 802.11 a/b/g/n/ac/ax specification: Dual band 2.4 GHz and 5 GHz
- MIMO with 20 MHz, 40 MHz, and 80 MHz channels
- Up to MCS9 data rates (1200 Mbps)
- Supports Bluetooth specification version 5.3
- For supported Bluetooth functions, refer to [Bluetooth SIG site](#) 
- WLAN interface: PCIe 2.0 and SDIO 3.0
- Bluetooth interface: HCI UART and PCM
- Temperature Range: - 40 °C to 85 °C
- Dimensions: 19.1 x 16.5 x 2.1 mm
- Weight: 1355 mg
- MSL: 3
- Surface-mount type
- RoHS compliant

3 Ordering Information

Table 2 describes the ordering information.

Table 2: Ordering Information

Ordering Part Number	Description
LBEE5ZZ1XL-774	Module order
LBEE5ZZ1XL-SMP	Sample module order (If module samples are not available through distribution, contact Murata referencing this part number)
EAR00387	Embedded Artists Type 1XL M.2 EVB (default EVB available through distribution)

4 Block Diagram

The Type 1XL block diagram is presented in **Figure 1**.

Figure 1: Block Diagram

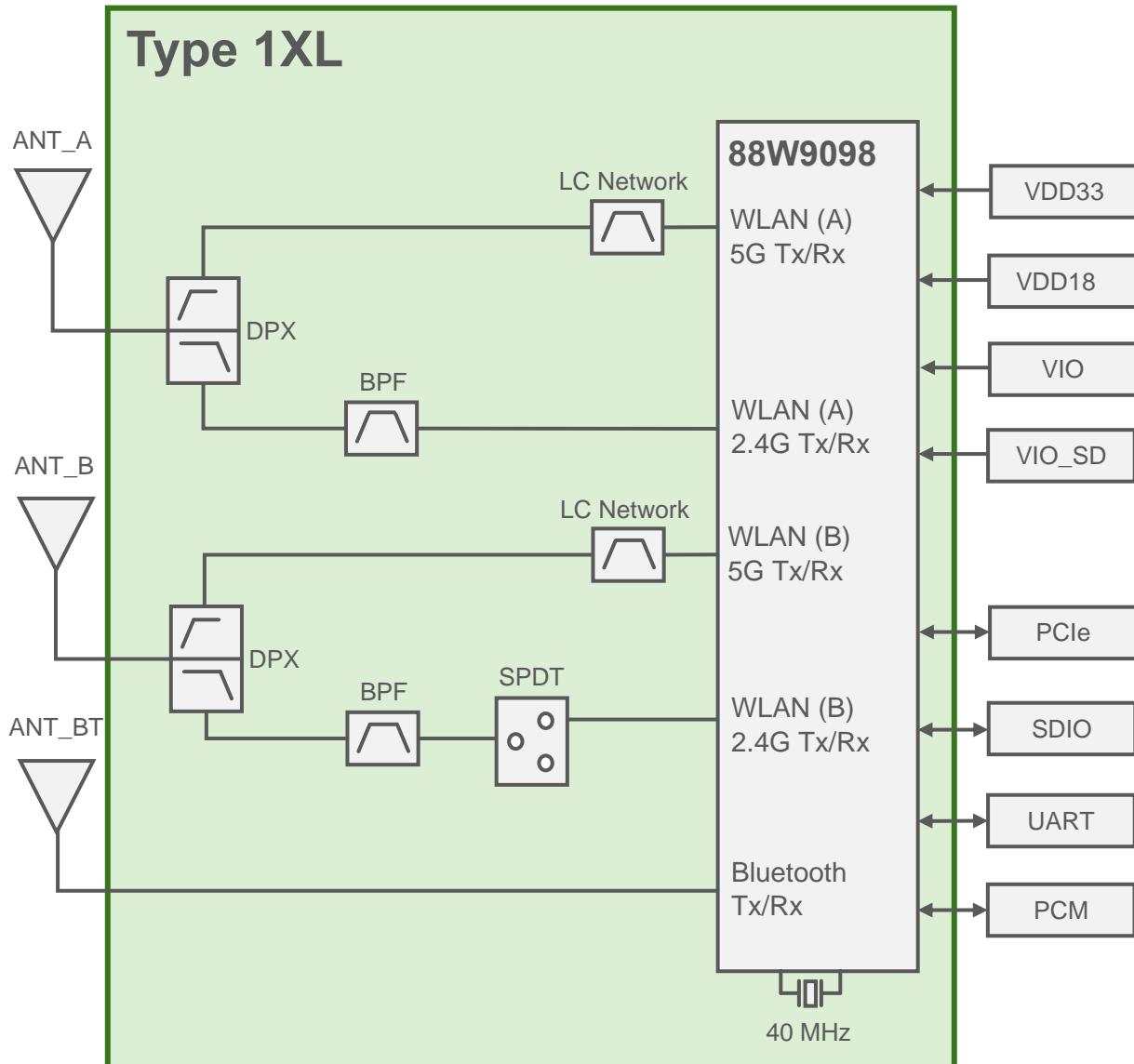

5 Certification Information

This section has information about radio and Bluetooth certification.

5.1 Radio Certification

Table 3 shows the radio certification information.



Table 3: Radio Certification

Country	ID	Country Code
USA (FCC)	VPYLBEE5ZZ1XL	US
Canada (IC)	772C-LBEE5ZZ1XL	CA
Europe	EN300328/301893, EN300440 conducted test report is prepared.	DE
Japan	Japanese type certification is prepared.  001-P01770	JP



Each country code is defined by Murata's DB.txt file. Please ask your contact person from Murata.

5.2 Bluetooth Qualification

- QDID: 184816
- Set Bluetooth Tx Power to Class 1 by using [bt_power_config_1.sh](#) .
- For supported Bluetooth functions, refer to [Bluetooth SIG site](#) .

6 Dimensions, Markings and Terminal Configurations

This section provides information about dimensions, markings, and terminal configuration for Type 1XL and the related parameters. **Figure 2** shows the dimensions, markings, and terminal configurations.

Figure 2: Dimensions, Marking and Terminal Configurations

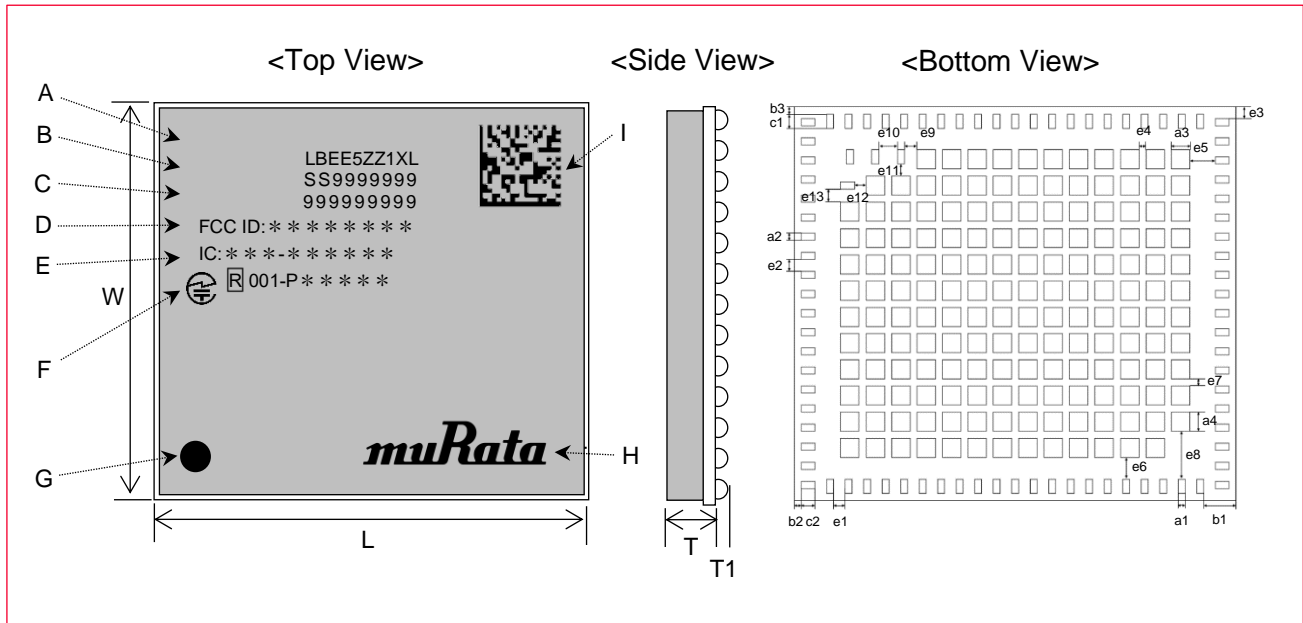

Table 4 describes the Type 1XL markings.

Table 4: Markings

Marking	Meaning
A	Module Type
B	Production Process Number
C	Serial Number
D	FCC ID
E	ISED ID
F	Japan certification mark & ID
G	Pin-1 Marking
H	Murata Logo
I	2D code

Table 5 describes the Type 1XL dimensions.

Table 5: Dimensions

Mark	Dimensions (mm)	Mark	Dimensions (mm)	Mark	Dimensions (mm)
L	19.1 +/- 0.2	W	16.5 +/- 0.2	T	2.1 max
T1	0.45 typ.	a1	0.3 +/- 0.1	a2	0.3 +/- 0.1

Mark	Dimensions (mm)	Mark	Dimensions (mm)	Mark	Dimensions (mm)
a3	0.8 +/- 0.1	a4	0.8 +/- 0.1	b1	1.4 +/- 0.2
b2	0.3 +/- 0.2	b3	0.3 +/- 0.2	c1	0.6 +/- 0.1
c2	0.6 +/- 0.1	e1	0.5 +/- 0.1	e2	0.5 +/- 0.1
e3	0.5 +/- 0.2	e4	0.3 +/- 0.1	e5	1.1 +/- 0.1
e6	0.9 +/- 0.1	e7	0.3 +/- 0.1	e8	2.0 +/- 0.1
e9	0.55 +/- 0.1	e10	0.8 +/- 0.1	e11	0.5 +/- 0.1
e12	0.5 +/- 0.1	e13	0.55 +/- 0.1		

Figure 3 shows Type 1XL Structure.

Figure 3: Structure

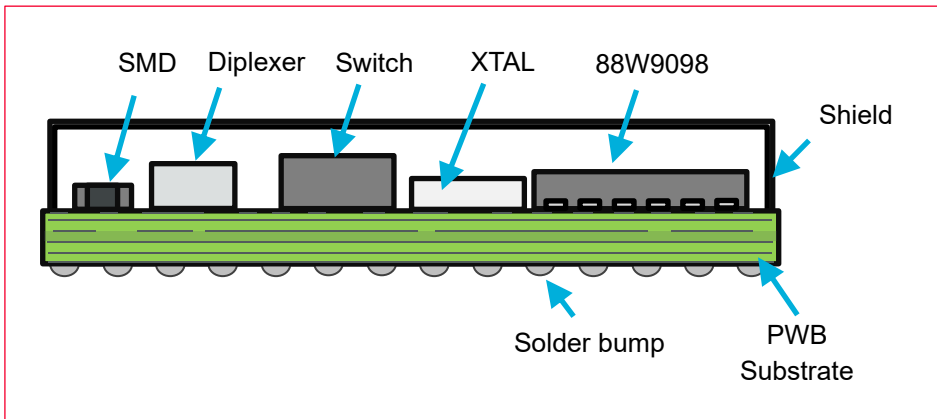

7 Module Pin Descriptions

This section has the pin descriptions of Type 1XL and pin assignments layout descriptions.

7.1 Pin Assignments

This section describes the pin assignments to terminals. Type 1XL pin-assignment top view is presented in **Figure 4**.

Figure 4: Pin Assignments Top View

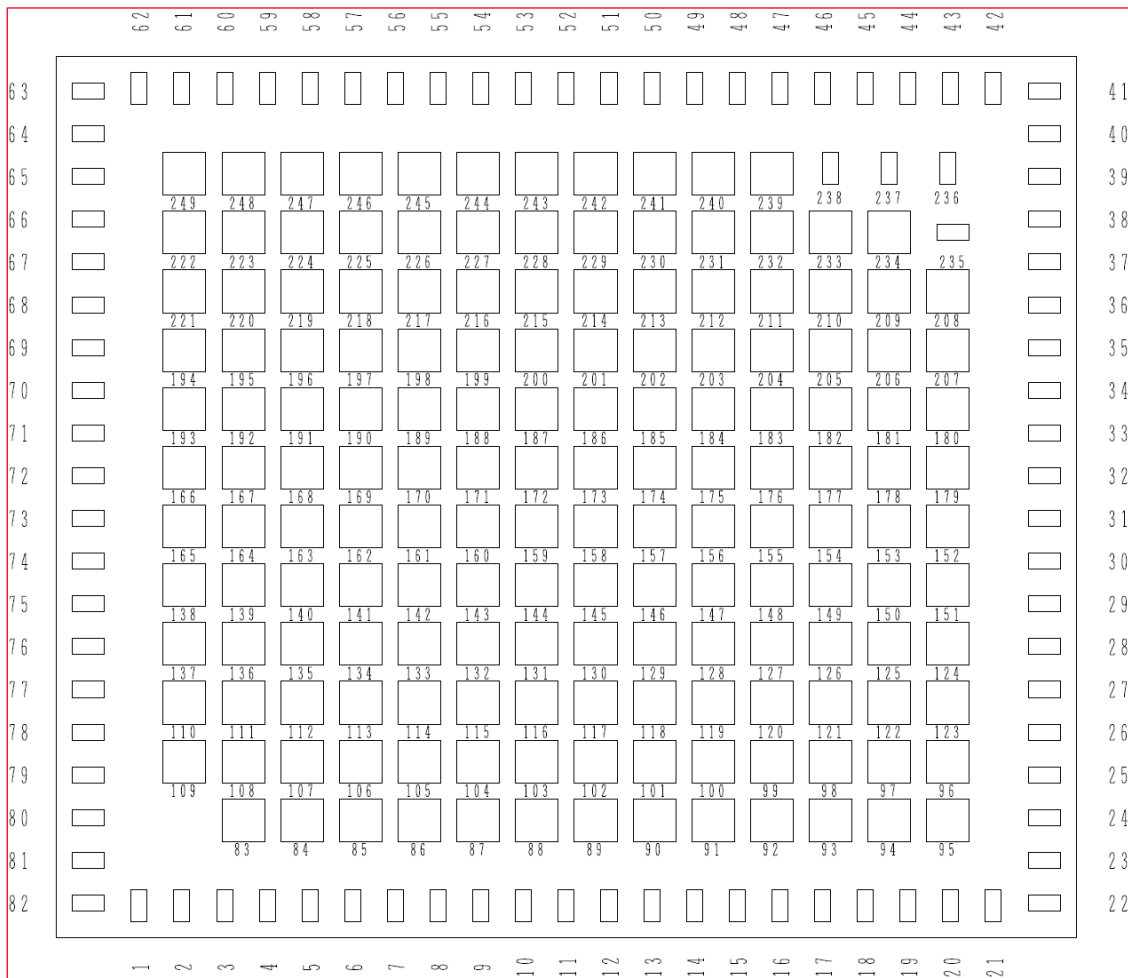

Table 6 lists the Type 1XL terminal configurations.

Table 6: Terminal Configurations

No.	Terminal Name	No.	Terminal Name	No.	Terminal Name
1	GND	31	GND	61	GPIO[26]
2	GND	32	NC	62	GPIO[27]
3	CONFIG_HOST[0]	33	NC	63	GND
4	CONFIG_HOST[1]	34	GND	64	GND
5	CONFIG_HOST[2]	35	VIO_SD	65	BT_RF_OUT
6	GPIO[1]	36	SD_CLK	66	GND
7	GPIO[0]	37	SD_CMD	67	GND
8	GPIO[14]	38	SD_D[0]	68	NC
9	GPIO[4]	39	SD_D[1]	69	GND
10	GPIO[6]	40	SD_D[2]	70	GPIO[22]
11	GPIO[5]	41	GND	71	GPIO[23]
12	GPIO[7]	42	SD_D[3]	72	GPIO[19]

No.	Terminal Name	No.	Terminal Name	No.	Terminal Name
13	GPIO[16]	43	PCIE_PERST_N	73	GPIO[18]
14	GPIO[15]	44	PCIE_CLKREQ_N	74	GPIO[17]
15	PDn	45	PCIE_WAKE_N	75	GND
16	GND	46	W_DISABLE1N	76	WL_B_ANT/ WL_B_BT_ANT
17	VDD33	47	GPIO[31]	77	GND
18	VDD33	48	GPIO[29]	78	GND
19	VIO	49	GPIO[30]	79	GND
20	VDD18	50	GPIO[28]	80	WL_A_ANT
21	VDD18	51	GPIO[3]	81	GND
22	GND	52	GPIO[2]	82	GND
23	PCIE_CLK_N	53	GPIO[11]	83-234	GND
24	PCIE_CLK_P	54	GPIO[10]	235	RF_CNTL0_N
25	GND	55	GPIO[9]	236	RF_CNTL3_P
26	PCIE_TX_P	56	GPIO[8]	237	RF_CNTL2_N
27	PCIE_TX_N	57	GPIO[12]	238	RF_CNTL1_P
28	GND	58	GPIO[13]	239- 248	GND
29	PCIE_RX_N	59	GPIO[24]	249	NC
30	PCIE_RX_P	60	GPIO[25]		

7.2 Pin Descriptions

Table 7 has the pin descriptions.

Table 7: Pin Descriptions

No.	Terminal Name	Type	Power Supply	Description
1	GND	GND		Ground
2	GND	GND		Ground
3	CONFIG_HOST[0]	I	VDD18	Host configuration options. Selects the host interface used for Wi-Fi and Bluetooth. See Section 7.3 . Internal pull-up
4	CONFIG_HOST[1]	I	VDD18	Host configuration options. Selects the host interface used for Wi-Fi and Bluetooth. See Section 7.3 . Internal pull-up
5	CONFIG_HOST[2]	I	VDD18	Host configuration options. Selects the host interface used for Wi-Fi and Bluetooth. See Section 7.3 . Internal pull-down(51 kΩ) on this pin
6	GPIO[1]	I/O	VIO	GPIO[1]
7	GPIO[0]	I/O	VIO	GPIO[0]

No.	Terminal Name	Type	Power Supply	Description
8	GPIO[14]	I/O	VIO	CONFIG_AUTO_REF_DET GPIO[14] Internal pull-down(51 kΩ) on this pin Keep open or input level high until finished power up sequence.
9	GPIO[4]	I/O	VIO	PCM Mode: Receive PCM input. I2S Mode: Receive I2S input. GPIO[4]
10	GPIO[6]	I/O	VIO	PCM Mode: PCM clock I2S Mode: I2S bit clock <ul style="list-style-type: none"> • Output if master • Input if slave GPIO[6]
11	GPIO[5]	I/O	VIO	PCM Mode: Transmit PCM output. I2S Mode: Transmit I2S output. GPIO[5]
12	GPIO[7]	I/O	VIO	PCM Mode: PCM frame sync. I2S Mode: I2S left-right clock. <ul style="list-style-type: none"> • Output if master • Input if slave GPIO[7]
13	GPIO[16]	I/O	VIO	GPIO[16] Keep open or input level high until finished power up sequence.
14	GPIO[15]	I/O	VIO	GPIO[15] Keep open or input level high until finished power up sequence.
15	PDn	I	VDD18	Full power-down (input) (active low) <ul style="list-style-type: none"> • 0 = full power-down mode • 1 = normal operation mode • PDn can accept an input of 1.8V to 4.5V • PDn may be driven by the host • PDn must be high for normal operation No internal pull-up on this pin. Connect to power down pin (GPIO) of host or tie to power rail. External host required to drive this pin high for normal operation mode.
16	GND	GND		Ground
17	VDD33	P		3.3V Voltage Input
18	VDD33	P		3.3V Voltage Input
19	VIO	P		1.8V/3.3V Digital I/O Power Supply
20	VDD18	P		1.8V Voltage Input
21	VDD18	P		1.8V Voltage Input
22	GND	GND		Ground
23	PCIE_CLK_N	I	VDD18	PCI Express Differential Clock Input—Negative
24	PCIE_CLK_P	I	VDD18	PCI Express Differential Clock Input—Positive
25	GND	GND	-	Ground
26	PCIE_TX_P	O	VDD18	PCI Express Transmit Data—Positive
27	PCIE_TX_N	O	VDD18	PCI Express Transmit Data—Negative

No.	Terminal Name	Type	Power Supply	Description
28	GND	GND		Ground
29	PCIE_RX_N	I	VDD18	PCI Express Receive Data—Negative
30	PCIE_RX_P	I	VDD18	PCI Express Receive Data—Positive
31	GND	GND		Ground
32	NC			No Connection
33	NC			No Connection
34	GND	GND		Ground
35	VIO_SD	P		1.8V/3.3V Digital I/O SDIO power supply. <ul style="list-style-type: none"> For SDIO ultra high speed mode (25 to 208 MHz), VIO_SD must be 1.8V. For SDIO default mode (up to 25 MHz) and high speed mode (up to 50 MHz), VIO_SD must be 1.8V or 3.3V. Need to be applied even in PCIE mode.
36	SD_CLK	I	VIO_SD	SDIO 4-bit Mode: Clock input SDIO 1-bit Mode: Clock input Internal pull-up
37	SD_CMD	I/O	VIO_SD	SDIO 4-bit Mode: Command/response (input/output) SDIO 1-bit Mode: Command line Internal pull-up
38	SD_D[0]	I/O	VIO_SD	SDIO 4-bit Mode: Data line Bit[0] SDIO 1-bit Mode: Data line Internal pull-up
39	SD_D[1]	I/O	VIO_SD	SDIO 4-bit Mode: Data line Bit[1] SDIO 1-bit Mode: Interrupt Internal pull-up
40	SD_D[2]	I/O	VIO_SD	SDIO 4-bit Mode: Data line Bit[2] or read wait (optional) SDIO 1-bit Mode: Read wait (optional) Internal pull-up
41	GND	GND	-	Ground
42	SD_D[3]	I/O	VIO_SD	SDIO 4-bit Mode: Data line Bit[3] SDIO 1-bit Mode: Reserved Internal pull-up
43	PCIE_PERST_N	I	VIO	PCIe host indication to reset the device (input)(active low) Note: Muxed with GPIO[20].(input/output) Internal pull-up.
44	PCIE_CLKREQ_N	I/O	VIO	PCIe clock request (input/output) (active low) Note: An external pull-up (on host side) is required.
45	PCIE_WAKE_N	I/O	VIO	PCIe wake signal (input/output) (active low) Note: An external pull-up (on host side) is required.
46	W_DISABLE1N	I	VIO	GPIO Mode: GPIO[21] (input/output) Default Mode: W_DISABLE1n (input) (active low) Host indication to disable the Wi-Fi function of the device. See GPIO[12] for W_DISABLE2n (input) (active low).
47	GPIO[31]	I/O	VIO	GPIO Mode: GPIO[31] (input/output) JTAG Mode: JTAG_TDO, JTAG test data (output) Coexistence Mode: UART_LTE_SOUT (LTE coexistence data output signal)
48	GPIO[29]	I/O	VIO	GPIO Mode: GPIO[29] (input/output) JTAG Mode: JTAG_TMS, JTAG controller select (input)

No.	Terminal Name	Type	Power Supply	Description
49	GPIO[30]	I/O	VIO	GPIO Mode: GPIO[30] (input/output) JTAG Mode: JTAG_TDI, JTAG test data (input) Coexistence Mode: UART_LTE_SIN (LTE coexistence data input signal)
50	GPIO[28]	I/O	VIO	GPIO Mode: GPIO[28] (input/output) JTAG Mode: JTAG_TCK, JTAG test clock (input)
51	GPIO[3]	I/O	VIO	GPIO Mode: GPIO[3] (input/output) LED Mode: LED_OUT_BT (output) I2S Mode: I2S_CCLK (output, optional) PCM Mode: PCM_MCLK (output, optional)
52	GPIO[2]	I/O	VIO	GPIO Mode: GPIO[2] (input/output) LED Mode: LED_OUT_WLAN (output)
53	GPIO[11]	I/O	VIO	GPIO Mode: GPIO[11] (input/output) UART Mode: UART_RTSn (output) (active low)
54	GPIO[10]	I/O	VIO	GPIO Mode: GPIO[10] (input/output) UART Mode: UART_CTSn (input) (active low)
55	GPIO[9]	I/O	VIO	GPIO Mode: GPIO[9] (input/output) UART Mode: UART_SIN (input)
56	GPIO[8]	I/O	VIO	GPIO Mode: GPIO[8] (input/output) UART Mode: UART_SOUT (output)
57	GPIO[12]	I/O	VIO	GPIO Mode: GPIO[12] (input/output) UART Mode: UART_DSRRn (input) (active low) Default Mode: W_DISABLE2n (input) (active low) Host indication to disable the Wi-Fi function of the device. See GPIO[21] for W_DISABLE1n (input) (active low).
58	GPIO[13]	I/O	VIO	GPIO Mode: GPIO[13] (input/output) UART Mode: UART_DTRn (output) (active low)
59	GPIO[24]	I/O	VIO	GPIO Mode: GPIO[24] (input/output)
60	GPIO[25]	I/O	VIO	GPIO Mode: GPIO[25] (input/output)
61	GPIO[26]	I/O	VIO	GPIO Mode: GPIO[26] (input/output)
62	GPIO[27]	I/O	VIO	GPIO Mode: GPIO[27] (input/output)
63	GND	GND		Ground
64	GND	GND		Ground
65	BT_RF_OUT	RF		Bluetooth Transmit/Receive
66	GND	GND		Ground
67	GND	GND		Ground
68	NC	NC		NC
69	GND	GND		Ground
70	GPIO[22]	I/O	VDD33	GPIO[22]
71	GPIO[23]	I/O	VDD33	GPIO[23]
72	GPIO[19]	I/O	VIO	GPIO[19]
73	GPIO[18]	I/O	VIO	GPIO[18]
74	GPIO[17]	I/O	VIO	GPIO[17]
75	GND	GND		Ground
76	WL_B_ANT	RF		WLAN Transmit/Receive – Path B
77	GND	GND		Ground

No.	Terminal Name	Type	Power Supply	Description
78	GND	GND		Ground
79	GND	GND		Ground
80	WL_A_ANT	RF		WLAN Transmit/Receive – Path A
81	GND	GND		Ground
82	GND	GND		Ground
83-234	GND	GND		Ground
235	RF_CNTL0_N	O	VDD33	RF Control 0-RF Control Output Low (output)
236	RF_CNTL3_P	O	VDD33	RF Control 3-RF Control Output High (output)
237	RF_CNTL2_N	O	VDD33	RF Control 2-RF Control Output Low (output)
238	RF_CNTL1_P	O	VDD33	RF Control 1-RF Control Output High (output)
239-248	GND	GND		Ground
249	NC	GND		No Connection

7.3 Configuration Pins

Table 8 describes the configuration pins.

Table 8: Configuration Pins

Strap Value			WLAN	Bluetooth/LE
CONFIG_HOST[2]	CONFIG_HOST[1]	CONFIG_HOST[0]		
0	0	0	SDIO	UART
0	0	1	reserved	reserved
0	1	0	reserved	reserved
0	1	1	PCIe	UART
1	0	0	reserved	reserved
1	0	1	reserved	reserved
1	1	0	reserved	reserved
1	1	1	reserved	reserved

7.4 Pin States

Pin states information for the tables below include:

- After firmware is downloaded, the pads (GPIO, Serial interface, RF control) are programmed in functional mode per the functionality of the pins.
- For SDIO, once the command is received from the host, the pads are configured accordingly.
- Pull-up and pull-down are only effective when the pad is in input mode.
- The power-down state shown is the default configuration. Many pads have programmable power-down values, which can be set by firmware.

- Do not need any termination to the open pins in input mode that have an Internal pull-up/pull-down resistor (PU/PD). Do not need any termination to the open pins in output mode. Do not need any termination to PCIE signals in SDIO mode.

Table 9: I/O State Table

Pin Name	Supply	No Pad Power State ¹	Reset State	HW State	PD State	PD Prog	Internal PU/PD	Int'l Pull Value [Ω]
GPIO[0]	VIO	tristate	output	output	drive low	yes	nominal PU	100K
GPIO[1]	VIO	tristate	input	input	tristate	yes	weak PU	800K
GPIO[2]	VIO	tristate	input	input	tristate	yes	nominal PU	100K
GPIO[3]	VIO	tristate	input	input	tristate	yes	nominal PU	100K
GPIO[4]	VIO	tristate	input	input	tristate	yes	weak PU	800K
GPIO[5]	VIO	tristate	input	input	tristate	yes	weak PU	800K
GPIO[6]	VIO	tristate	input	input	tristate	yes	weak PU	800K
GPIO[7]	VIO	tristate	input	input	tristate	yes	nominal PU	100K
GPIO[8]	VIO	tristate	input	input	drive low	yes	nominal PU	100K
GPIO[9]	VIO	tristate	input	input	tristate	yes	nominal PU	100K
GPIO[10]	VIO	tristate	input	input	tristate	yes	nominal PU	100K
GPIO[11]	VIO	tristate	input	input	drive high	yes	nominal PU	100K
GPIO[12]	VIO	tristate	input	input	tristate	yes	nominal PD	100K
GPIO[13]	VIO	tristate	input	input	drive high	yes	nominal PU	100K
GPIO[14]	VIO	tristate	input	input	tristate	yes	weak PU	800K
GPIO[15]	VIO	tristate	input	input	drive high	yes	weak PU	800K
GPIO[16]	VIO	tristate	input	input	tristate	yes	weak PD	800K
GPIO[17]	VIO	tristate	input	input	tristate	yes	weak PD	800K
GPIO[18]	VIO	tristate	input	input	tristate	yes	weak PD	800K
GPIO[19]	VIO	tristate	input	input	tristate	yes	weak PU	800K
GPIO[20]	VIO	tristate	input	input	drive high	yes	nominal PU	100K
GPIO[21]	VIO	tristate	input	input	tristate	yes	nominal PU	100K
GPIO[22]	VDD33	tristate	input	input	drive high	yes	weak PU	800K
GPIO[23]	VDD33	tristate	input	input	drive low	yes	weak PU	800K
GPIO[24]	VIO	tristate	input	input	tristate	yes	nominal PU	100K
GPIO[25]	VIO	tristate	input	input	drive high	yes	nominal PU	100K
GPIO[26]	VIO	tristate	input	input	tristate	yes	nominal PU	100K
GPIO[27]	VIO	tristate	input	input	tristate	yes	nominal PU	100K
GPIO[28]	VIO	tristate	input	input	tristate	yes	nominal PU	100K
GPIO[29]	VIO	tristate	input	input	tristate	yes	nominal PD	100K
GPIO[30]	VIO	tristate	input	input	tristate	yes	nominal PU	100K
GPIO[31]	VIO	tristate	input	input	tristate	yes	nominal PU	100K
SD_CLK	VIO	tristate	input	input	tristate	no	nominal PU	100K
SD_CMD	VIO	tristate	input	input	tristate	no	nominal PU	100K
SD_D[0]	VIO	tristate	input	input	tristate	no	nominal PU	100K
SD_D[1]	VIO	tristate	input	input	tristate	no	nominal PU	100K
SD_D[2]	VIO	tristate	input	input	tristate	no	nominal PU	100K
SD_D[3]	VIO	tristate	input	input	tristate	no	nominal PU	100K

¹ Maximum input voltage is 0.4V when VIO has no power (or in uncertain situations)

Pin Name	Supply	No Pad Power State ¹	Reset State	HW State	PD State	PD Prog	Internal PU/PD	Int'l Pull Value [Ω]
PCIE_CLKP	AVDD18							
PCIE_CLKN	AVDD18	—	—	—	—	—	—	—
PCIE_TXP	AVDD18	—	—	—	—	—	—	—
PCIE_TXN	AVDD18	—	—	—	—	—	—	—
PCIE_RXP	AVDD18	—	—	—	—	—	—	—
PCIE_RXN	AVDD18	—	—	—	—	—	—	—
PCIE_WAKE_N	VIO	tristate	input	output	n/a	n/a	n/a	—
PCIE_CLKREQ_N	VIO	tristate	input	output	n/a	n/a	n/a	—
PCIE_PERST_N	VIO	tristate	input	input	drive high	yes	nominal PU	100K
CONFIG_HOST[0]	AVDD18	tristate	input	input	tristate	no	weak PU	800K
CONFIG_HOST[1]	AVDD18	tristate	input	input	tristate	no	weak PU	800K
CONFIG_HOST[2]	AVDD18	tristate	input	input	tristate	no	weak PU	800K
RF_CNTL0_N	VDD33	tristate	input	output	drive low	yes	nominal PU	100K
RF_CNTL1_P	VDD33	tristate	input	output	drive low	yes	weak PU	800K
RF_CNTL2_N	VDD33	tristate	input	output	drive low	yes	weak PU	800K
RF_CNTL3_P	VDD33	tristate	input	output	drive low	yes	weak PU	800K
PDn	AVDD18	—	—	—	—	—	—	—

7.5 SDIO Pin Descriptions

Table 10 shows the SDIO pin descriptions. **Figure 5** shows the SDIO modes.

Table 10: SDIO Pin Descriptions

No.	Pin Name	(i) SD 4-bit Mode		(ii) SD 1-bit Mode	
55	SD_CLK	CLK	Clock	CLK	Clock
59	SD_D[0]	DATA0	Data line 0	DATA	Data line
61	SD_D[1]	DATA1	Data line 1 /Interrupt	IRQ	Interrupt
63	SD_D[2]	DATA2	Data line 2	NC	Not used
65	SD_D[3]	DATA3	Data line 3	NC	Not used
57	SD_CMD	CMD	Command line	CMD	Command line

Figure 5: SDIO Modes

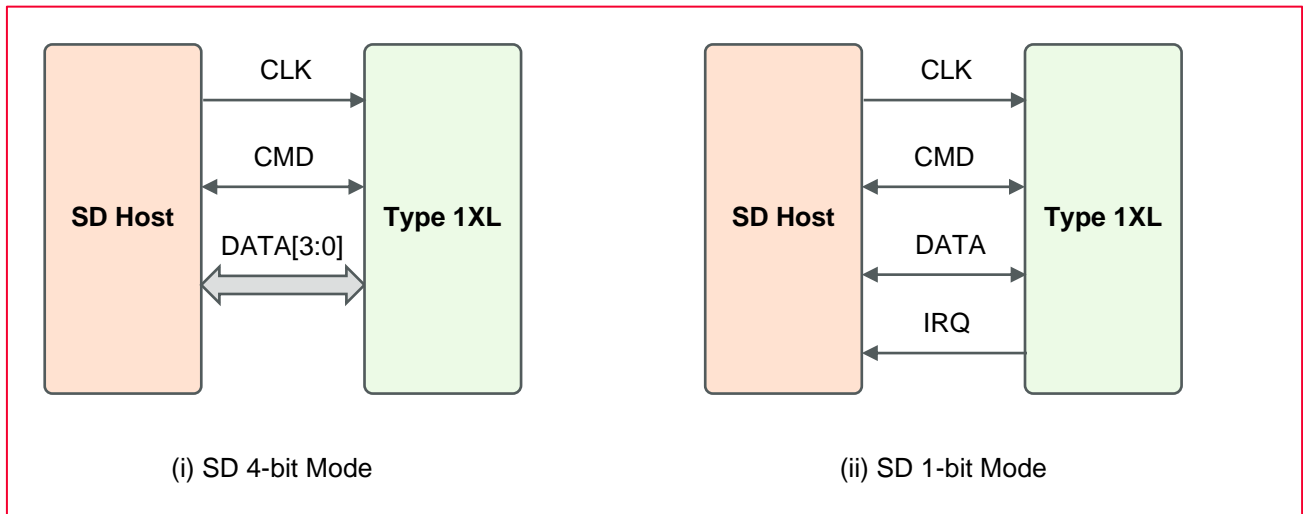

8 Absolute Maximum Ratings

Table 11 describes the absolute maximum ratings.

Table 11: Absolute Maximum Ratings

Parameter	Minimum	Maximum	Unit
Storage Temperature	-40	+85	°C
Supply Voltage	VDD33	3.63	V
	VDD18	2.16	V
	VIO (1.8V)	1.98	V
	VIO (3.3V)	3.63	V
	VIO_SD (1.8V)	1.98	V
	VIO_SD (3.3V)	3.63	V



Stresses in excess of the absolute ratings may cause permanent damage. Functional operation is not implied under these conditions. Exposure to absolute ratings for extended periods of time may adversely affect reliability. No damage assuming only one parameter is set at limit at a time with all other parameters are set within operating condition.

9 Operating Condition

9.1 Operating Condition

Type 1XL operating conditions are described in **Table 12**.

Table 12: Operating Conditions

Parameter		Minimum	Typical	Maximum	Unit
Operating Temperature Range ²	Ta	-40	+25	+85	°C
	Tj			+125	°C
Supply Voltage	VDD33	3.14	3.3	3.46	V
	VDD18	1.71	1.8	1.89	V
	VIO	1.71	1.8	1.89	V
		3.14	3.3	3.46	V
VIO_SD	1.71	1.8	1.89	V	
	3.14	3.3	3.46	V	
IO Current	VIO & VIO_SD		0.1	0.5	mA
Peak current	VDD33		1150	1200	mA
	VDD18		1873	2000	mA



Operation beyond the recommended operating conditions is neither recommended nor guaranteed. Peak current of VDD33 and VDD18 happen during DPD calibration when the firmware is downloaded.

9.2 Digital I/O Requirements

The digital I/O requirements are listed in **Table 13**.

Table 13: Digital I/O Requirements Parameters

Symbol	Parameter	Condition	Minimum	Typical	Maximum	Unit
V _{IH}	Input high voltage		0.7 * VIO		VIO + 0.4	V
V _{IL}	Input low voltage		-0.4		0.3 * VIO	V
V _{HYS}	Input hysteresis		100			mV
V _{OH}	Output high voltage		VIO - 0.4			V
V _{OL}	Output low voltage				0.4	V

9.3 Package Thermal Conditions

- $R\psi_{jt} : 3.6 \text{ } ^\circ\text{C/W}$
- $R\psi_{jt} = (T_j - T_t)/P$



T_j: Junction temperature (°C), T_t: Top temperature (°C), P: Total Power Consumption (W)

² Functionality is guaranteed but specifications require derating at extreme temperatures

Figure 6: Package Thermal Conditions

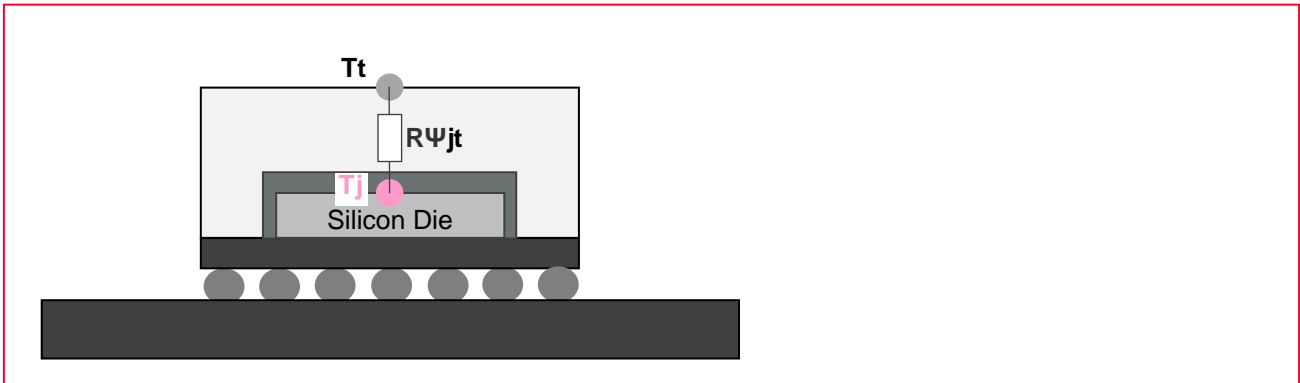

10 Power Sequence

This section describes the power-on and power-off sequences.

10.1 Power-On Sequence

10.1.1 Power-On Sequence for 3.3V

- Ramp-up time of VIO must be < 100 ms.
- Ramp-up time of VDD33 must be < 100 ms.
- Ramp-up time of VDD18 must be < 100 ms.

Figure 7 shows the power-on sequence for VIO 3.3V.

Figure 7: Power-On Sequence Graph for VIO 3.3V

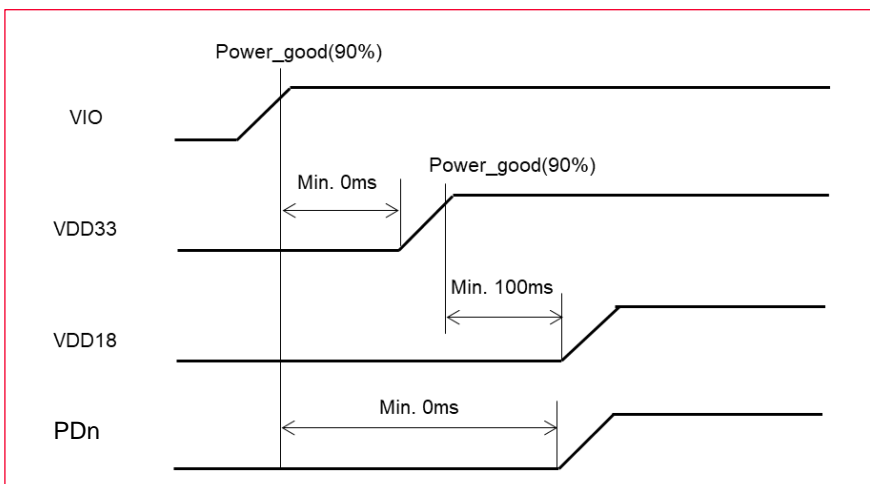

10.1.2 Power-On Sequence for 1.8V

- Ramp-up time of VIO must be < 100 ms.
- Ramp-up time of VDD33 must be < 100 ms.
- Ramp-up time of VDD18 must be < 100 ms.

Figure 8 shows the power-on sequence for VIO 1.8V.

Figure 8: Power-On Sequence Graph for VIO 1.8V

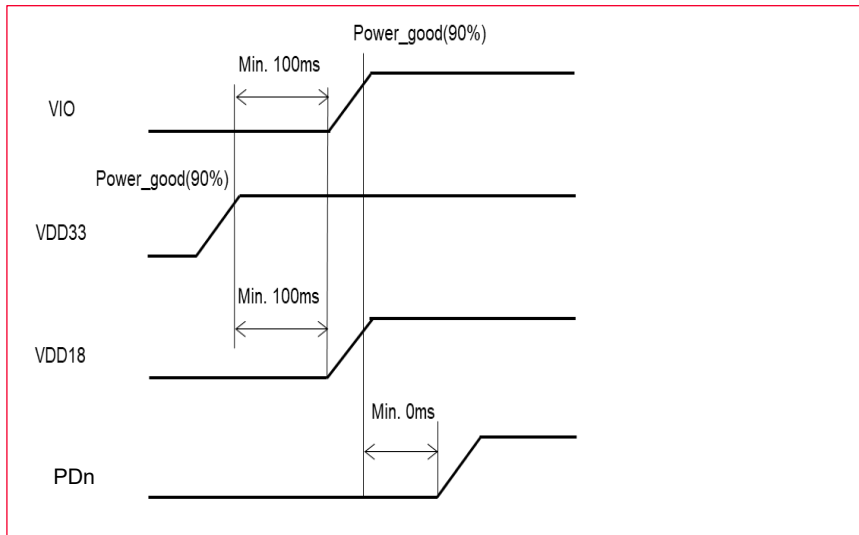

VIO should be the same as VDD18 or earlier. The VIO can ramp up after power_good state of VDD33. At that time the VDD18 can be the same or later than VIO.

10.2 Power-Off Sequence

Figure 9 shows the power-off sequence graph.

Figure 9: Power-Off Sequence Graph

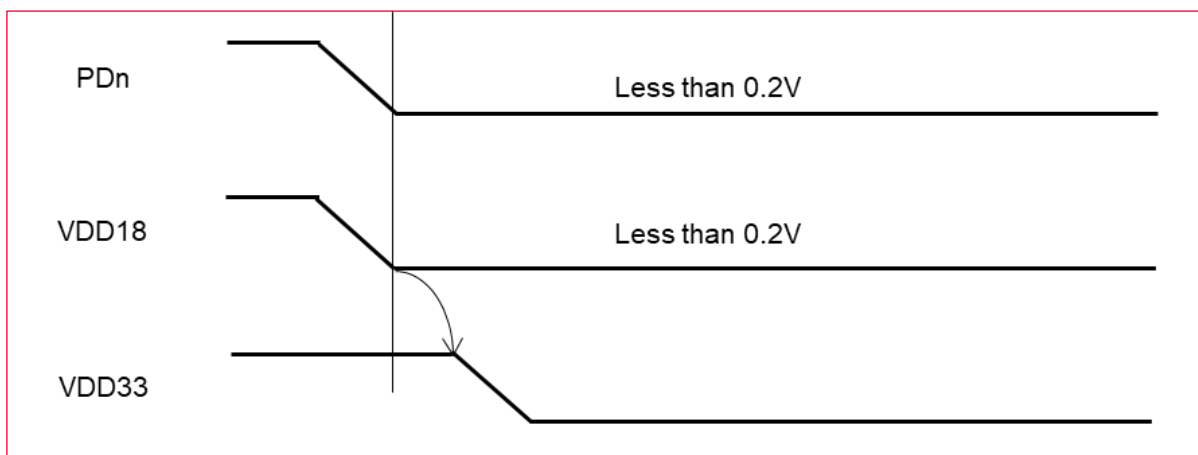



To reduce leakage, ramp down VDD18 before VDD33 when powering down the SoC.
Specific timing for VIO is not required for its power-down.

11 Host Interface Specification

This section describes various SDIO specifications along with the SDIO timing data.

11.1 SDIO Specifications

- The SDIO host interface pins are powered from the VIO_SD voltage supply.
- The SDIO electrical specifications are identical for 4-bit SDIO and 1-bit SDIO transfer modes.

11.1.1 Default Speed, High Speed Modes

Figure 10 shows the default speed mode.

Figure 10: SDIO Protocol Timing Diagram - Default Speed Mode (3.3V)

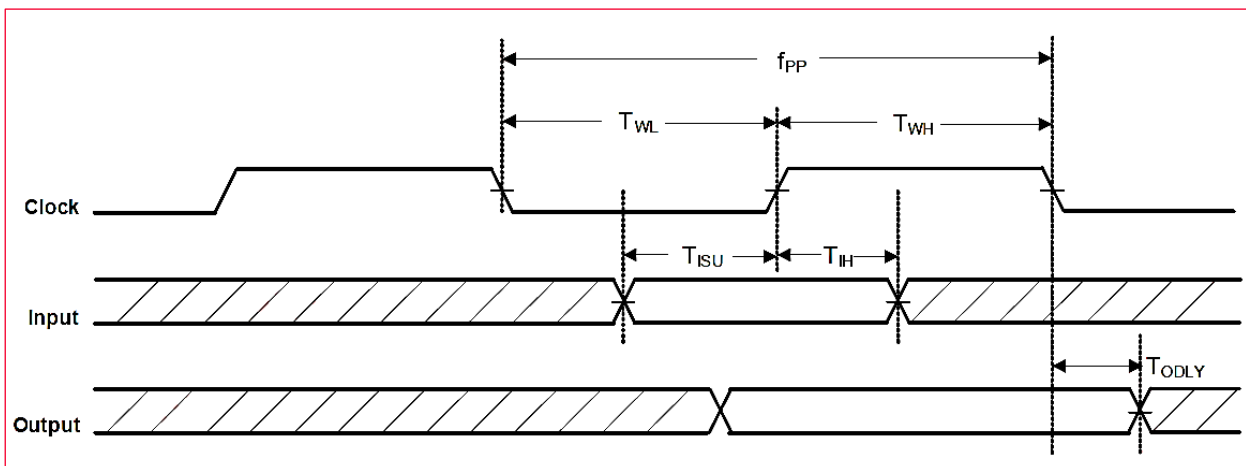

Figure 11 shows the high speed modes.

Figure 11: SDIO Protocol Timing Diagram - High Speed Mode (3.3V)

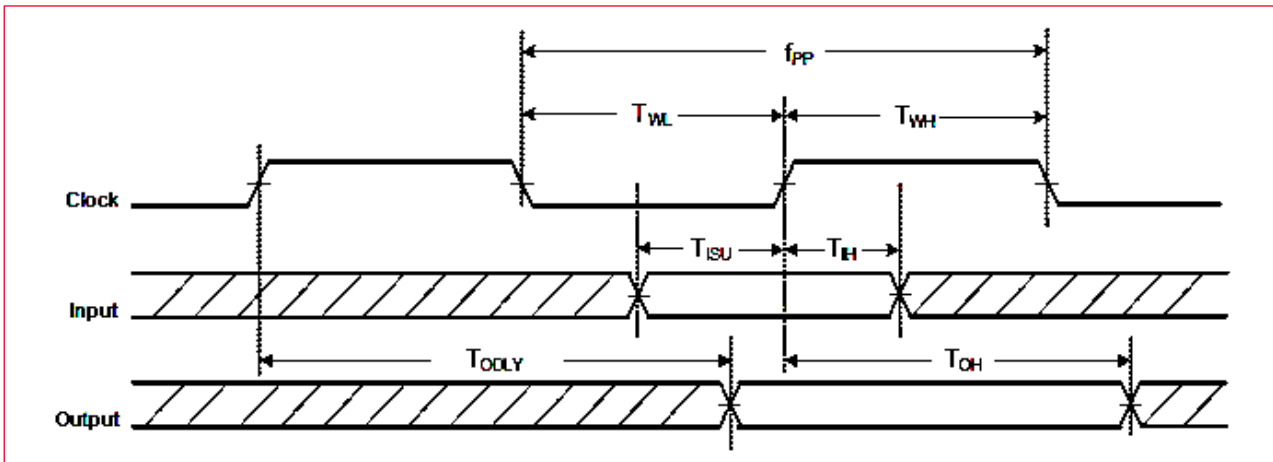

Table 14 shows the SDIO timing data at default and high speed modes.

Table 14: SDIO Timing Data - Default Speed, High Speed Modes (3.3V)

Symbol	Parameter	Condition	Minimum	Typical	Maximum	Unit
f_{PP}	Clock frequency	Normal	0		25	MHz
		High speed	0		50	MHz
T_{WL}	Clock low time	Normal	10			ns
		High speed	7			ns
T_{WH}	Clock high time	Normal	10			ns
		High speed	7			ns
T_{ISU}	Input setup time	Normal	5			ns
		High speed	6			ns
T_{IH}	Input hold time	Normal	5			ns
		High speed	2			ns
T_{ODLY}	Output delay time	Normal			14	ns
	CL ≤ 40 pF (1 card)	High speed			14	ns
T_{OH}	Output hold time	High speed	2.5			ns



Over full range of values specified in the Recommended Operating Conditions unless otherwise specified.

11.1.2 SDR12, SDR25, SDR50 Modes up to 100 MHz (1.8V)

This section describes SDR12, SDR25, SDR50 modes up to 100 MHz (1.8V) along with the timing data. **Figure 12** shows the SDIO protocol timing diagram for SDR12, SDR25, SDR50 modes up to 100 MHz for 1.8V.

Figure 12: SDIO Protocol Timing Diagram - SDR12, SDR25, SDR50 Modes

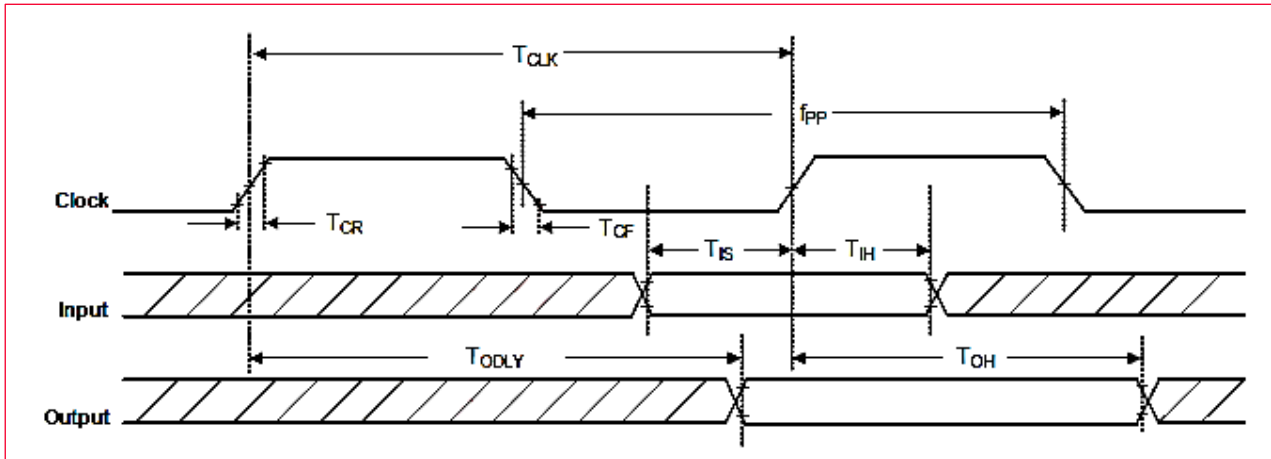

Table 15 shows the SDIO timing data for SDR12, SDR25, SDR50 modes up to 100 MHz for 1.8V.

Table 15: SDIO Timing Data - SDR12, SDR25, SDR50 Modes

Symbol	Parameter	Condition	Minimum	Typical	Maximum	Unit
f_{PP}	Clock frequency	SDR12/25/50	25		100	MHz
T_{IS}	Input setup time	SDR12/25/50	3			ns
T_{IH}	Input hold time	SDR12/25/50	0.8			ns
T_{CLK}	Clock time	SDR12/25/50	10		40	ns
T_{CR}, T_{CF}	Rise time, fall time $T_{CR}, T_{CF} < 2$ ns (maximum) at 100 MHz CCARD = 10 pF	SDR12/25/50			$0.2 * T_{CLK}$	ns
T_{ODLY}	Output delay time $CL \leq 30$ pF	SDR12/25/50			7.5	ns
T_{OH}	Output hold time $CL = 15$ pF	SDR12/25/50	1.5			ns



Over full range of values specified in the Recommended Operating Conditions unless otherwise specified.

11.1.3 SDR104 Mode at 208 MHz (1.8V)

Figure 13 shows the SDIO protocol timing diagram for SDR104 mode (208 MHz).

Figure 13: SDIO Protocol Timing Diagram - SDR104 Mode

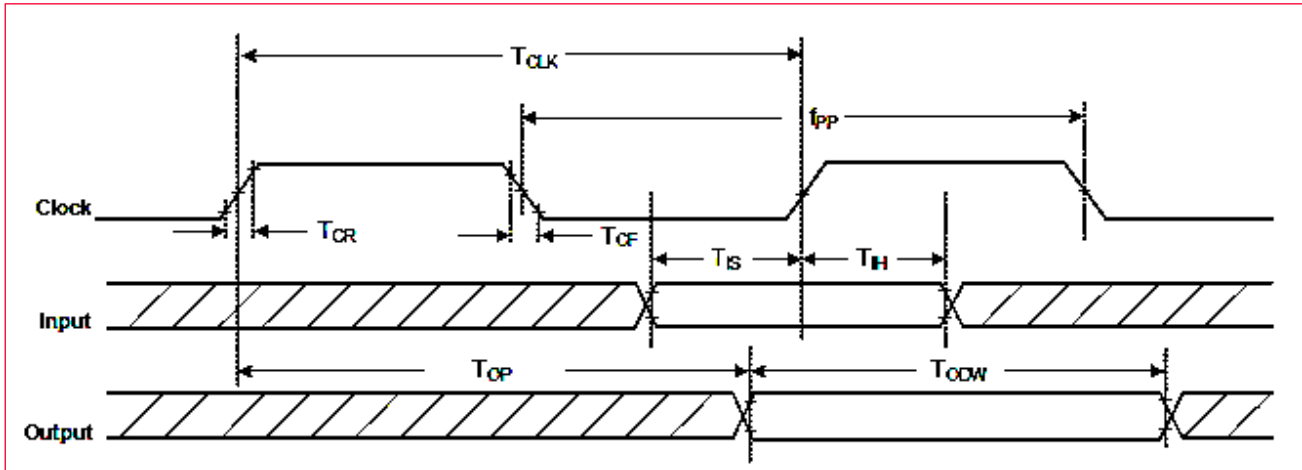

Table 16 shows the SDIO protocol timing data for SDR104 mode (208 MHz).

Table 16: SDIO Timing Data - SDR104 Mode

Symbol	Parameter	Condition	Minimum	Typical	Maximum	Unit
f_{PP}	Clock frequency	SDR104	0		208	MHz
T_{IS}	Input setup time	SDR104	1.4			ns
T_{IH}	Input hold time	SDR104	0.8			ns
T_{CLK}	Clock time	SDR104	4.8			ns
T_{CR}, T_{CF}	Rise time, fall time TCR, TCF < 0.96 ns (maximum) at 208 MHz CCARD = 10 pF	SDR104			$0.2 * T_{CLK}$	ns
T_{OP}	Card output phase	SDR104	0		10	ns
T_{ODW}	Output timing of variable data window	SDR104	2.88			ns



Over full range of values specified in the Recommended Operating Conditions unless otherwise specified.

11.1.4 DDR50 Mode at 50 MHz

Figure 14 shows SDIO CMD timing diagram for DDR50 mode at 50 MHz.

Figure 14: SDIO CMD Timing Diagram - DDR50 Mode

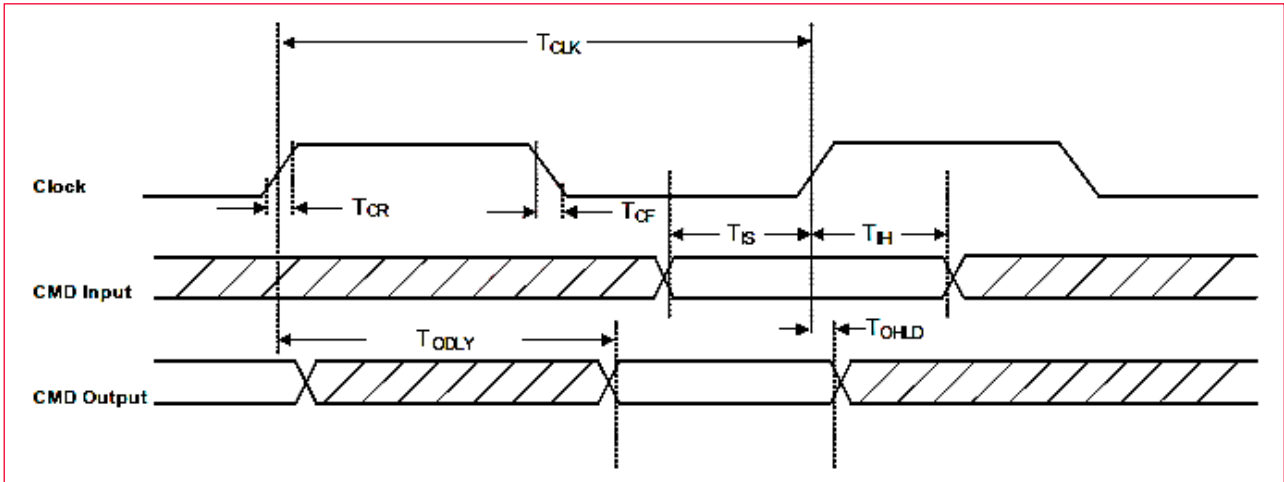

Figure 15 SDIO DAT[3:0] timing diagram for DDR50 mode at 50 MHz.

Figure 15: SDIO DAT[3:0] Timing Diagram - DDR50 Mode

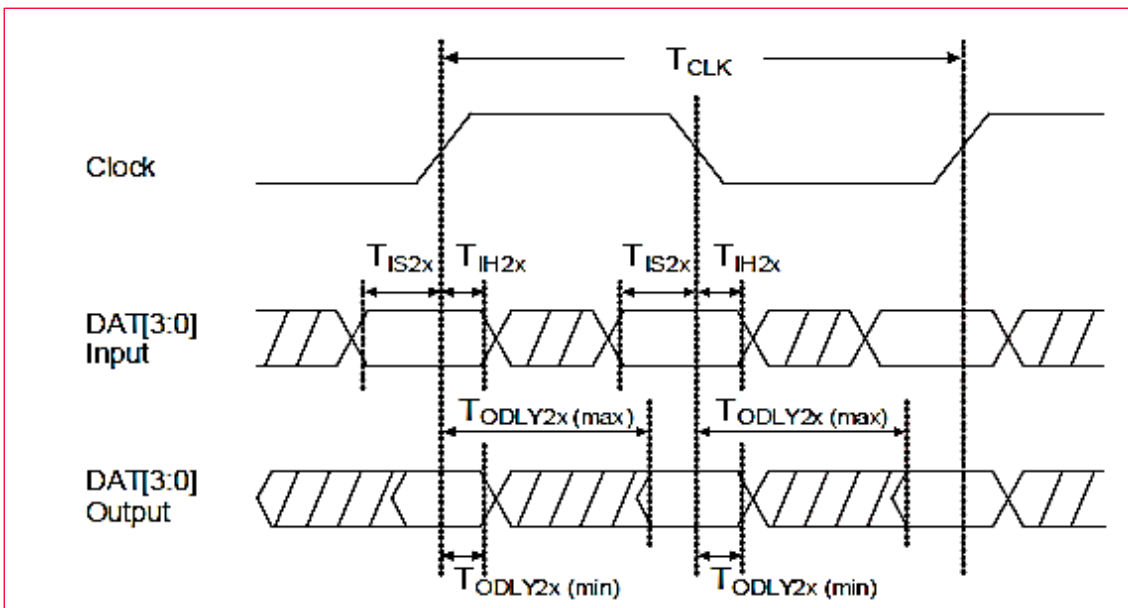

Table 17 describes the SDIO timing data.

Table 17: SDIO Timing Data - DDR50 Mode

Symbol	Parameter	Condition	Minimum	Typical	Maximum	Unit
Clock						
T_{CLK}	Clock time	DDR50	20			ns

Symbol	Parameter	Condition	Minimum	Typical	Maximum	Unit
	50 MHz (maximum) between rising edges					
T_{CR}, T_{CF}	Rise time, fall time $T_{CR}, T_{CF} < 4.00$ ns (maximum) at 50 MHz $C_{CARD} = 10$ pF	DDR50			$0.2 * T_{CLK}$	ns
Clock Duty		DDR50	45		55	%
CMD Input (referenced to clock rising edge)						
T_{IS}	Input setup time $C_{CARD} \leq 10$ pF (1 card)	DDR50	6			ns
T_{IH}	Input hold time $C_{CARD} \leq 10$ pF (1 card)	DDR50	0.8			ns
CMD Output (referenced to clock rising edge)						
T_{ODLY}	Output delay time during data transfer mode $C_L \leq 30$ pF (1 card)	DDR50			13.7	ns
$T_{OHL D}$	Output hold time $C_L \geq 15$ pF (1 card)	DDR50	1.5			ns
DAT[3:0] Input (referenced to clock rising and falling edges)						
T_{IS2x}	Input setup time $C_{CARD} \leq 10$ pF (1 card)	DDR50	3			ns
T_{IH2x}	Input hold time $C_{CARD} \leq 10$ pF (1 card)	DDR50	0.8			ns
DAT[3:0] Output (referenced to clock rising and falling edges)						
$T_{ODLY2x (max)}$	Output delay time during data transfer mode $C_L \leq 25$ pF (1 card)	DDR50			7.0	ns
$T_{ODLY2x (min)}$	Output hold time $C_L \geq 15$ pF (1 card)	DDR50	1.5			ns



Over full range of values specified in the Recommended Operating Conditions unless otherwise specified.

11.2 PCI Express Specifications

The PCI express host interface pins are powered from the AVDD18 voltage supply.

11.2.1 Differential Tx Output Electricals

This section describes the PCI express Tx output specifications data for 2.5 GT/s and 5 GT/s.



In accordance with PCI Express Base Specification, Revision 2.1 March 4, 2009.

PCI express Tx output specifications data for 2.5 GT/s is shown in **Table 18**.

Table 18: PCI Express Tx Output Specifications Data - 2.5 GT/s

Symbol	Parameter	Minimum	Typical	Maximum	Unit
UI	Unit Interval (UI) The specified UI is equivalent to a tolerance of ± 300 ppm for each Refclk source. Period does not account for SSC induced variations.	399.88		400.12	ps
$V_{TX-DIFF-PP}$	Differential peak-to-peak Tx voltage swing $V_{TX-DFFpp} = 2 * V_{TXD+} - V_{TXD-} $	0.8		1.2	V
$V_{TX-DIFF-PP-LOW}$	Low power differential peak-to-peak Tx voltage swing $V_{TX-DFFpp} = 2 * V_{TXD+} - V_{TXD-} $	0.4		1.2	V
$V_{TX-DE-RATIO-3.5dB}$	Tx de-emphasis level ratio (3.5 dB)	3.0		4.0	dB
T_{TX-EYE}	Tx eye including all jitter sources	0.75			UI
$T_{TX-EYE-MEDIAN-to-MAX-JITTER}$	Maximum time between jitter median and maximum deviation from median	-		0.125	UI
$T_{TX-RISE-FALL}$	Tx rise/fall time Measured differentially from 20% to 80% of swing.	0.125			UI
$R_{LTX-DIFF}$	Tx package plus Si differential return loss	10			dB
R_{LTX-CM}	Tx package plus Si common mode return loss	6			dB
$V_{TX-CM-AC-P}$	Tx AC common mode voltage		20		mV
$I_{TX-SHORT}$	Tx short circuit current limit			90	mA
$V_{TX-DC-CM}$	Tx DC common mode voltage	0		3.6	V
$V_{TX-CM-DC-ACTIVE-IDLE-DELTA}$	Absolute delta of DC common mode voltage during L0 and electrical idle.	0		100	mV
$V_{TX-IDLE-DIFF-AC-p}$	Electrical idle differential peak output voltage	0		20	mV
$V_{TX-RCV-DETECT}$	Voltage change allowed during receiver detection			600	mV
$T_{TX-IDLE-MIN}$	Minimum time spent in electrical idle	20			ns

Symbol	Parameter	Minimum	Typical	Maximum	Unit
T _{TX-IDLE-SET-TO-IDLE}	Maximum time to transition to a valid electrical idle after sending an electrical idle ordered set			8	ns
T _{TX-IDLE-TO-DIFF-DATA}	Maximum time to transition to valid diff signaling after leaving electrical idle			8	ns
T _{CROSSLINK}	Crosslink random timeout			1.0	ms
C _{TX}	AC coupling capacitor	75		200	nF

PCI express Tx output specifications data for 5 GT/s is shown in **Table 19**.

Table 19: PCI Express Tx Output Specifications Data - 5 GT/s

Symbol	Parameter	Minimum	Typical	Maximum	Unit
UI	Unit Interval (UI) The specified UI is equivalent to a tolerance of ± 300 ppm for each Refclk source. Period does not account for SSC induced variations.	199.94		200.06	ps
V _{TX-DIFFpp}	Differential peak-to-peak Tx voltage swing $V_{TX-DIFFpp} = 2 * V_{TXD+} - V_{TXD-} $	0.8		1.2	V
V _{TX-DIFFpp-LOW}	Low power differential peak-to-peak Tx voltage swing $V_{TX-DIFFpp} = 2 * V_{TXD+} - V_{TXD-} $	0.4		1.2	V
V _{TX-DE-RATIO-3.5dB}	Tx de-emphasis level ratio (3.5 dB)	3.0		4.0	dB
V _{TX-DE-RATIO-6dB}	Tx de-emphasis level ratio (6 dB)	5.5		6.5	dB
T _{MIN-PULSE}	Instantaneous lone pulse width Measured relative to rising/falling pulse.	0.9			UI
T _{TX-EYE}	Tx eye including all jitter sources	0.75			UI
T _{TX-HF-DJ-DD}	Tx deterministic jitter > 1.5 MHz Deterministic jitter only.			0.15	UI
T _{TX-LF-RMS}	Tx RMS jitter < 1.5 MHz Total energy measured over a 10 kHz - 1.5 MHz range.		3.0		Ps RMS
T _{TX-RISE-FALL}	Tx rise/fall time Measured differentially from 20% to 80% of swing.	0.15			UI
RL _{TX-DIFF}	Tx package plus Si differential return loss (1.25-2.5 GHz)	10			dB
	Tx package plus Si differential return loss (0.05-1.25 GHz)	8			
RL _{TX-CM}	Tx package plus Si common mode return loss	6			dB
V _{TX-CM-AC-PP}	Tx AC common mode voltage			100	mVPP
I _{TX-SHORT}	Tx short circuit current limit			90	mA

Symbol	Parameter	Minimum	Typical	Maximum	Unit
V _{TX-DC-CM}	Tx DC common mode voltage	0		3.6	V
V _{TX-CM-DC-ACTIVE-IDLE-DELTA}	Absolute delta of DC common mode voltage during L0 and electrical idle	0		100	mV
V _{TX-IDLE-DIFF-AC-p}	Electrical idle differential peak output voltage $V_{TX-IDLE-DIFF-DC} = V_{TX-IDLE-D+} - V_{TX-IDLE-D-} \leq 20 \text{ mV}$	0		20	mV
V _{TX-IDLE-DIFF-DC}	DC Electrical idle differential peak output voltage $V_{TX-IDLE-DIFF-DC} = V_{TX-IDLE-D+} - V_{TX-IDLE-D-} \leq 5 \text{ mV}$	0		5	mV
V _{TX-RCV-DETECT}	Voltage change allowed during receiver detection			600	mV
T _{TX-IDLE-MIN}	Minimum time spent in electrical idle	20			ns
T _{TX-IDLE-SET-TO-IDLE}	Maximum time to transition to a valid electrical idle after sending an electrical idle ordered set.			8	ns
T _{TX-IDLE-TO-DIFF-DATA}	Maximum time to transition to valid differential signaling after leaving electrical idle.			8	ns
T _{CROSSLINK}	Crosslink random timeout			1.0	ms
C _{TX}	AC coupling capacitor	75		200	nF

11.2.2 Differential Rx Input Electricals

This section describes the PCI express Rx input specifications data for 2.5 GT/s and 5 GT/s.



This is in accordance with PCI Express Base Specification, Revision 2.1 March 4, 2009.

Table 20 describes the PCI express Rx input specifications data for 2.5 GT/s.

Table 20: PCI Express Rx Input Specifications Data - 2.5 GT/s

Symbol	Parameter	Minimum	Typical	Maximum	Unit
UI	Unit Interval (UI) UI does not account for SSC induced variations.	399.88		400.12	ps
V _{RX-DIFF-PP-CC}	Differential Rx peak-to-peak voltage for common Refclk Rx architecture	0.175		1.2	V
V _{RX-DIFF-PP-DC}	Differential Rx peak-to-peak voltage for data clocked Rx architecture	0.175		1.2	V
T _{RX-EYE}	Rx eye time opening. Minimum eye time at Rx pins to yield a 10 ⁻¹² BER	0.40			UI
T _{RX-EYE-MEDIAN-to-MAX-JITTER}	Maximum time delta between median and deviation from median			0.3	UI
V _{RX-CM-ACp}	AC peak common mode input voltage			150	mV
RL _{RX-DIFF}	Differential return loss	15			dB
RL _{RX-CM}	Common mode return loss	0		3.6	dB
Z _{RX-DIFF-DC}	DC differential input impedance	80	100	120	W
Z _{RX-DC}	DC input impedance	40	50	60	W
Z _{RX-HIGH-IMP-DC}	Powered down DC input impedance	200			kΩ
V _{RX-IDLE-DET-DIFF-p-p}	Electrical idle detect threshold	65		175	mV
T _{RX-IDLE-DET-DIFF-ENTERTIME}	Unexpected electrical idle enter detect threshold integration time			10	ms
L _{RX-SKEW}	Total skew			20	ns

Table 21 describes the PCI express Rx input specifications data for 5 GT/s.

Table 21: PCI Express Rx Input Specifications Data - 5 GT/s

Symbol	Parameter	Minimum	Typical	Maximum	Unit
UI	Unit Interval (UI) UI does not account for SSC induced variations.	199.94		200.06	ps
V _{RX-DIFF-PP-CC}	Differential Rx peak-to-peak voltage for common Refclk Rx architecture	0.120		1.2	V
V _{RX-DIFF-PP-DC}	Differential Rx peak-to-peak voltage for data clocked Rx architecture	0.100		1.2	V
T _{RX-TJ-CC}	Maximum Rx inherent total timing error for common Refclk Rx architecture			0.40	UI
T _{RX-TJ-DC}	Maximum Rx inherent total timing error for data clocked Rx architecture			0.34	UI
T _{RX-DJ-DD-CC}	Maximum Rx inherent deterministic timing error for common Refclk Rx architecture			0.30	UI
T _{RX-DJ-DD-DC}	Maximum Rx inherent deterministic timing error for data clocked Rx architecture			0.24	UI
T _{RX-MIN-PLISE}	Minimum width pulse at Rx Measured to account for worst T _j at 10 ⁻¹² BER.	0.6			UI
V _{RX-CM-ACp}	AC peak common mode input voltage			150	mV
RL _{RX-DIFF}	Differential return loss	15			dB
RL _{RX-CM}	Common mode return loss	0		3.6	dB
Z _{RX-DIFF-DC}	DC differential input impedance	80	100	120	W
Z _{RX-DC}	DC input impedance	40	50	60	W
Z _{RX-HIGH-IMP-DC}	Powered down DC input impedance	200			kΩ
V _{RX-IDLE-DET-DIFF-p-p}	Electrical idle detect threshold	65		175	mV
T _{RX-IDLE-DET-DIFF-ENTERTIME}	Unexpected electrical idle enter detect threshold integration time			10	ms
L _{RX-SKEW}	Total skew			20	ns

12 DC/RF Characteristics

ALL DC/RF characteristics are defined by the files listed in **Table 22**.

Table 22: DC/RF Characteristic Files

Characteristics	Filenames
WLAN Tx Power	txpower_US.bin, txpower_CA.bin, txpower_EU.bin, txpower_JP.bin
WLAN Regulatory Limit	db.txt
Energy Detect	ed_mac.bin
Bluetooth Power	bt_power_config_1.sh (Class 1)

Figure 16 shows the burst current definition.

Figure 16: Burst Current Definition

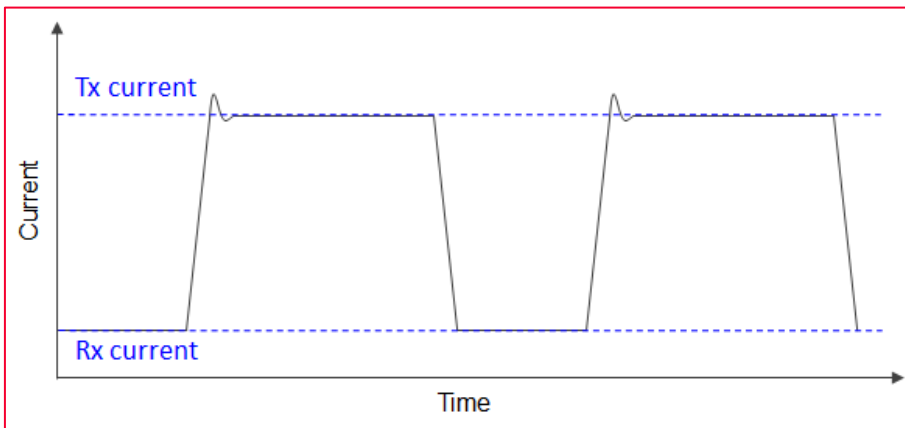

12.1 DC/RF Characteristics for IEEE 802.11b - 2.4 GHz

Table 23: DC/RF Characteristics for IEEE 802.11b - 2.4 GHz

Items	Contents
Specification	IEEE 802.11b
Mode	DSSS / CCK
Channel Frequency	2412 - 2472 MHz
Data rate	1, 2, 5.5, 11 Mbps

12.1.1 High-Rate Condition for IEEE 802.11b - 2.4 GHz

Conditions: 25 °C, VDD33 = 3.3V, VDD18 = 1.8V, VIO = 1.8V, Output power setting = 18 dBm, 11 Mbps mode

Table 24: High-Rate Condition for IEEE 802.11b - 2.4 GHz

Items		Contents			
DC Characteristics		Minimum	Typical	Maximum	Unit
DC current					
• Tx mode	VDD18		280		mA
	VDD33		220		mA
	VDD18 (MIMO)		370		mA
	VDD33 (MIMO)		450		mA
• Rx mode	VDD18		280		mA
	VDD33		0.2		mA
	VDD18 (MIMO)		300		mA
	VDD33 (MIMO)		0.2		mA
Tx Characteristics		Minimum	Typical	Maximum	Unit
Output Power		16	18	20	dBm
Spectrum Mask Margin					
• 1st side lobes		0			dB
• 2nd side lobes		0			dB
Power-on/off ramp				2.0	μs
RF Carrier Suppression		15		-	dB
Modulation Accuracy				35	%
Frequency Tolerance		-20		20	ppm
Spurious Emissions					
• 30 - 47 MHz (BW = 100 kHz)				-36	dBm
• 47 - 74 MHz (BW = 100 kHz)				-54	dBm
• 74 - 87.5 MHz (BW = 100 kHz)				-36	dBm
• 87.5 - 118 MHz (BW = 100 kHz)				-54	dBm
• 118 - 174 MHz (BW = 100 kHz)				-36	dBm
• 174 - 230 MHz (BW = 100 kHz)				-54	dBm
• 230 - 470 MHz (BW = 100 kHz)				-36	dBm
• 470 - 862 MHz (BW = 100 kHz)				-54	dBm
• 862 - 1000 MHz (BW = 100 kHz)				-36	dBm
• 1000 - 12750 MHz (BW = 1 MHz)				-30	dBm
Rx Characteristics		Minimum	Typical	Maximum	Unit
Minimum Input Level (FER ≤ 8%)				-76	dBm
Maximum Input Level (FER ≤ 8%)		-10			dBm
Adjacent Channel Rejection (FER < 8%)		35			dB

12.1.2 Low-Rate Condition for IEEE 802.11b - 2.4 GHz

Conditions: 25 °C, VDD33 = 3.3V, VDD18 = 1.8V VIO = 1.8V, Output power setting = 18 dBm, 1 Mbps mode

Table 25: Low-Rate Condition for IEEE 802.11b - 2.4 GHz

Items		Contents			
DC Characteristics		Minimum	Typical	Maximum	Unit
DC current					
• Tx mode	VDD18		280		mA
	VDD33		210		mA
	VDD18 (MIMO)		370		mA
	VDD33 (MIMO)		450		mA
• Rx mode	VDD18		280		mA
	VDD33		0.2		mA
	VDD18 (MIMO)		300		mA
	VDD33 (MIMO)		0.2		mA
Tx Characteristics		Minimum	Typical	Maximum	Unit
Output Power		16	18	20	dBm
Spectrum Mask Margin					
• 1st side lobes		0			dB
• 2nd side lobes		0			dB
Power-on/off ramp				2.0	μs
RF Carrier Suppression		15			dB
Modulation Accuracy				35	%
Frequency Tolerance		-20		20	ppm
Spurious Emissions					
• 30 - 47 MHz (BW = 100 kHz)				-36	dBm
• 47 - 74 MHz (BW = 100 kHz)				-54	dBm
• 74 - 87.5 MHz (BW = 100 kHz)				-36	dBm
• 87.5 - 118 MHz (BW = 100 kHz)				-54	dBm
• 118 - 174 MHz (BW = 100 kHz)				-36	dBm
• 174 - 230 MHz (BW = 100 kHz)				-54	dBm
• 230 - 470 MHz (BW = 100 kHz)				-36	dBm
• 470 - 862 MHz (BW = 100 kHz)				-54	dBm
• 862 - 1000 MHz (BW = 100 kHz)				-36	dBm
• 1000 - 12750 MHz (BW = 1 MHz)				-30	dBm
Rx Characteristics		Minimum	Typical	Maximum	Unit
Minimum Input Level (FER ≤ 8%)				-80	dBm
Maximum Input Level (FER ≤ 8%)		-10			dBm
Adjacent Channel Rejection (FER < 8%)		35			dB

12.2 DC/RF Characteristics for IEEE 802.11g - 2.4 GHz

Table 26: DC/RF Characteristics for IEEE 802.11g - 2.4 GHz

Items	Contents
Specification	IEEE 802.11g
Mode	OFDM
Channel Frequency	2412 - 2472 MHz
Data rate	6, 9, 12, 18, 24, 36, 48, 54 Mbps

12.2.1 High-Rate Condition for IEEE 802.11g - 2.4 GHz

Conditions: 25 °C, VDD33 = 3.3V, VDD18 = 1.8V VIO = 1.8V, Output power setting = 16 dBm, 54 Mbps mode

Table 27: High-Rate Condition for IEEE 802.11g - 2.4 GHz

Items		Contents			
DC Characteristics		Minimum	Typical	Maximum	Unit
DC current					
• Tx mode	VDD18		300		mA
	VDD33		180		mA
	VDD18 (MIMO)		410		mA
	VDD33 (MIMO)		370		mA
• Rx mode	VDD18		280		mA
	VDD33		0.2		mA
	VDD18 (MIMO)		300		mA
	VDD33 (MIMO)		0.2		mA
Tx Characteristics		Minimum	Typical	Maximum	Unit
Output Power		14	16	18	dBm
Spectrum Mask Margin					
• 9 MHz to 11 MHz (0 ~ -20 dBr)		0			dB
• 11 MHz to 20 MHz (-20 ~ -28 dBr)		0			dB
• 20 MHz to 30 MHz (-28 ~ -40 dBr)		0			dB
• 30 MHz to 33 MHz (-40 dBr)		0			dB
Constellation Error (EVM)				-25	dB
Frequency Tolerance		-20		20	ppm
Spurious Emissions					
• 30 - 47 MHz (BW = 100 kHz)				-36	dBm
• 47 - 74 MHz (BW = 100 kHz)				-54	dBm
• 74 - 87.5 MHz (BW = 100 kHz)				-36	dBm
• 87.5 - 118 MHz (BW = 100 kHz)				-54	dBm
• 118 - 174 MHz (BW = 100 kHz)				-36	dBm
• 174 - 230 MHz (BW = 100 kHz)				-54	dBm
• 230 - 470 MHz (BW = 100 kHz)				-36	dBm
• 470 - 862 MHz (BW = 100 kHz)				-54	dBm
• 862 - 1000 MHz (BW = 100 kHz)				-36	dBm
• 1000 - 12750 MHz (BW = 1 MHz)				-30	dBm
Rx Characteristics		Minimum	Typical	Maximum	Unit

Items	Contents			
Minimum Input Level (PER < 10%)			-65	dBm
Maximum Input Level (PER < 10%)	-20			dBm
Adjacent Channel Rejection (PER < 10%)	-1			dB

12.2.2 Low-Rate Condition for IEEE 802.11g - 2.4 GHz

Conditions: 25 °C, VDD33 = 3.3V, VDD18 = 1.8V VIO = 1.8V, Output power setting = 17 dBm, 6 Mbps mode

Table 28: Low-Rate Condition for IEEE 802.11g - 2.4 GHz

Items		Contents			
DC Characteristics		Minimum	Typical	Maximum	Unit
DC current					
• Tx mode	VDD18		300		mA
	VDD33		200		mA
	VDD18 (MIMO)		410		mA
	VDD33 (MIMO)		420		mA
• Rx mode	VDD18		280		mA
	VDD33		0.2		mA
	VDD18 (MIMO)		300		mA
	VDD33 (MIMO)		0.2		mA
Tx Characteristics		Minimum	Typical	Maximum	Unit
Output Power		15	17	19	dBm
Spectrum Mask Margin					
• 9 MHz to 11 MHz (0 ~ -20 dBr)		0			dB
• 11 MHz to 20 MHz (-20 ~ -28 dBr)		0			dB
• 20 MHz to 30 MHz (-28 ~ -40 dBr)		0			dB
• 30 MHz to 33 MHz (-40 dBr)		0			dB
Constellation Error (EVM)				-25	dB
Frequency Tolerance		-20		20	ppm
Spurious Emissions					
• 30 - 47 MHz (BW = 100 kHz)				-36	dBm
• 47 - 74 MHz (BW = 100 kHz)				-54	dBm
• 74 - 87.5 MHz (BW = 100 kHz)				-36	dBm
• 87.5 - 118 MHz (BW = 100 kHz)				-54	dBm
• 118 - 174 MHz (BW = 100 kHz)				-36	dBm
• 174 - 230 MHz (BW = 100 kHz)				-54	dBm
• 230 - 470 MHz (BW = 100 kHz)				-36	dBm
• 470 - 862 MHz (BW = 100 kHz)				-54	dBm
• 862 - 1000 MHz (BW = 100 kHz)				-36	dBm
• 1000 - 12750 MHz (BW = 1 MHz)				-30	dBm
Rx Characteristics		Minimum	Typical	Maximum	Unit
Minimum Input Level (PER < 10%)				-82	dBm
Maximum Input Level (PER < 10%)		-20			dBm
Adjacent Channel Rejection (PER < 10%)		-1			dB

12.3 DC/RF Characteristics for IEEE 802.11n - 2.4 GHz

Table 29: DC/RF Characteristics for IEEE 802.11n - 2.4 GHz

Items	Contents
Specification	IEEE 802.11n
Mode	OFDM
Channel Frequency	2412 - 2472 MHz
Data rate	MCS0 - MCS7

12.3.1 High-Rate Condition for IEEE 802.11n - 2.4 GHz

Conditions: 25 °C, VDD33 = 3.3V, VDD18 = 1.8V VIO = 1.8V, Output power setting = 15 dBm, MCS7 mode

Table 30: High-Rate Condition for IEEE 802.11n - 2.4 GHz

Items		Contents			
DC Characteristics		Minimum	Typical	Maximum	Unit
DC current					
• Tx mode	VDD18		300		mA
	VDD33		170		mA
	VDD18 (MIMO)		410		mA
	VDD33 (MIMO)		330		mA
• Rx mode	VDD18		280		mA
	VDD33		0.2		mA
	VDD18 (MIMO)		300		mA
	VDD33 (MIMO)		0.2		mA
Tx Characteristics		Minimum	Typical	Maximum	Unit
Output Power		13	15	17	dBm
Spectrum Mask Margin					
• 9 MHz to 11 MHz (0 ~ -20 dBr)		0			dB
• 11 MHz to 20 MHz (-20 ~ -28 dBr)		0			dB
• 20 MHz to 30 MHz (-28 ~ -45 dBr)		0			dB
• 30 MHz to 33 MHz (-45 dBr)		0			dB
Constellation Error (EVM) (Measured at enhanced mode)				-27	dB
Frequency Tolerance		-20		20	ppm
Spurious Emissions					
• 30 - 47 MHz (BW = 100 kHz)				-36	dBm
• 47 - 74 MHz (BW = 100 kHz)				-54	dBm
• 74 - 87.5 MHz (BW = 100 kHz)				-36	dBm
• 87.5 - 118 MHz (BW = 100 kHz)				-54	dBm
• 118 - 174 MHz (BW = 100 kHz)				-36	dBm
• 174 - 230 MHz (BW = 100 kHz)				-54	dBm
• 230 - 470 MHz (BW = 100 kHz)				-36	dBm
• 470 - 862 MHz (BW = 100 kHz)				-54	dBm
• 862 - 1000 MHz (BW = 100 kHz)				-36	dBm
• 1000 - 12750 MHz (BW = 1 MHz)				-30	dBm
Rx Characteristics		Minimum	Typical	Maximum	Unit

Items	Contents			
Minimum Input Level (PER ≤ 10%)			-64	dBm
Maximum Input Level (PER < 10%)	-20			dBm
Adjacent Channel Rejection (PER ≤ 10%)	-2			dB

12.3.2 Low-Rate Condition for IEEE 802.11n - 2.4 GHz

Conditions: 25 °C, VDD33 = 3.3V, VDD18 = 1.8V VIO = 1.8V, Output power setting = 16 dBm, MCS0 mode

Table 31: Low-Rate Condition for IEEE 802.11n - 2.4 GHz

Items		Contents			
DC Characteristics		Minimum	Typical	Maximum	Unit
DC current					
• Tx mode	VDD18		300		mA
	VDD33		190		mA
	VDD18 (MIMO)		410		mA
	VDD33 (MIMO)		380		mA
• Rx mode	VDD18		280		mA
	VDD33		0.2		mA
	VDD18 (MIMO)		300		mA
	VDD33 (MIMO)		0.2		mA
Tx Characteristics		Minimum	Typical	Maximum	Unit
Output Power		14	16	18	dBm
Spectrum Mask Margin					
• 9 MHz to 11 MHz (0 ~ -20 dBr)		0			dB
• 11 MHz to 20 MHz (-20 ~ -28 dBr)		0			dB
• 20 MHz to 30 MHz (-28 ~ -45 dBr)		0			dB
• 30 MHz to 33 MHz (-45 dBr)		0			dB
Constellation Error (EVM) (Measured at enhanced mode)				-27	dB
Frequency Tolerance		-20		20	ppm
Spurious Emissions					
• 30 - 47 MHz (BW = 100 kHz)				-36	dBm
• 47 - 74 MHz (BW = 100 kHz)				-54	dBm
• 74 - 87.5 MHz (BW = 100 kHz)				-36	dBm
• 87.5 - 118 MHz (BW = 100 kHz)				-54	dBm
• 118 - 174 MHz (BW = 100 kHz)				-36	dBm
• 174 - 230 MHz (BW = 100 kHz)				-54	dBm
• 230 - 470 MHz (BW = 100 kHz)				-36	dBm
• 470 - 862 MHz (BW = 100 kHz)				-54	dBm
• 862 - 1000 MHz (BW = 100 kHz)				-36	dBm
• 1000 - 12750 MHz (BW = 1 MHz)				-30	dBm
Rx Characteristics		Minimum	Typical	Maximum	Unit
Minimum Input Level (PER ≤ 10%)				-82	dBm
Maximum Input Level (PER < 10%)		-20			dBm
Adjacent Channel Rejection (PER ≤ 10%)		-2			dB

12.4 DC/RF Characteristics for IEEE 802.11ax - 2.4 GHz

Table 32: DC/RF Characteristics for IEEE 802.11ax - 2.4 GHz

Items	Contents
Specification	IEEE 802.11ax
Mode	OFDM
Channel Frequency	2412 - 2472 MHz
Data rate	MCS0 - MCS11

12.4.1 High-Rate Condition for IEEE 802.11ax - 2.4 GHz

Conditions: 25 °C, VDD33 = 3.3V, VDD18 = 1.8V VIO = 1.8V, Output power setting = 13 dBm, MCS11 mode

Table 33: High-Rate Condition for IEEE 802.11ax - 2.4 GHz

Items		Contents			
DC Characteristics		Minimum	Typical	Maximum	Unit
DC current					
• Tx mode	VDD18		300		mA
	VDD33		150		mA
	VDD18 (MIMO)		410		mA
	VDD33 (MIMO)		300		mA
• Rx mode	VDD18		280		mA
	VDD33		0.2		mA
	VDD18 (MIMO)		300		mA
	VDD33 (MIMO)		0.2		mA
Tx Characteristics		Minimum	Typical	Maximum	Unit
Output Power		11	13	15	dBm
Spectrum Mask Margin					
• 9 MHz to 11 MHz (0 ~ -20 dBr)		0			dB
• 11 MHz to 20 MHz (-20 ~ -28 dBr)		0			dB
• 20 MHz to 30 MHz (-28 ~ -45 dBr)		0			dB
• 30 MHz to 33 MHz (-45 dBr)		0			dB
Constellation Error (EVM) (Measured at enhanced mode)				-35	dB
Frequency Tolerance		-20		20	ppm
Spurious Emissions					
• 30 - 47 MHz (BW = 100 kHz)				-36	dBm
• 47 - 74 MHz (BW = 100 kHz)				-54	dBm
• 74 - 87.5 MHz (BW = 100 kHz)				-36	dBm
• 87.5 - 118 MHz (BW = 100 kHz)				-54	dBm
• 118 - 174 MHz (BW = 100 kHz)				-36	dBm
• 174 - 230 MHz (BW = 100 kHz)				-54	dBm
• 230 - 470 MHz (BW = 100 kHz)				-36	dBm
• 470 - 862 MHz (BW = 100 kHz)				-54	dBm
• 862 - 1000 MHz (BW = 100 kHz)				-36	dBm
• 1000 - 12750 MHz (BW = 1 MHz)				-30	dBm
Rx Characteristics		Minimum	Typical	Maximum	Unit

Items	Contents			
Minimum Input Level (PER ≤ 10%)			-69	dBm
Maximum Input Level (PER < 10%)	-20			dBm
Adjacent Channel Rejection (PER ≤ 10%)	-2			dB

12.4.2 Low-Rate Condition for IEEE 802.11ax - 2.4 GHz

Conditions: 25 °C, VDD33 = 3.3V, VDD18 = 1.8V VIO = 1.8V, Output power setting = 16 dBm, MCS0 mode

Table 34: Low-Rate Condition for IEEE 802.11ax - 2.4 GHz

Items		Contents			
DC Characteristics		Minimum	Typical	Maximum	Unit
DC current					
• Tx mode	VDD18		300		mA
	VDD33		190		mA
	VDD18 (MIMO)		420		mA
	VDD33 (MIMO)		390		mA
• Rx mode	VDD18		280		mA
	VDD33		0.2		mA
	VDD18 (MIMO)		300		mA
	VDD33 (MIMO)		0.2		mA
Tx Characteristics		Minimum	Typical	Maximum	Unit
Output Power		14	16	18	dBm
Spectrum Mask Margin					
•	9 MHz to 11 MHz (0 ~ -20 dBr)	0			dB
•	11 MHz to 20 MHz (-20 ~ -28 dBr)	0			dB
•	20 MHz to 30 MHz (-28 ~ -45 dBr)	0			dB
•	30 MHz to 33 MHz (-45 dBr)	0			dB
Constellation Error (EVM) (Measured at enhanced mode)				-19	dB
Frequency Tolerance		-20		20	ppm
Spurious Emissions					
•	30 - 47 MHz (BW = 100 kHz)			-36	dBm
•	47 - 74 MHz (BW = 100 kHz)			-54	dBm
•	74 - 87.5 MHz (BW = 100 kHz)			-36	dBm
•	87.5 - 118 MHz (BW = 100 kHz)			-54	dBm
•	118 - 174 MHz (BW = 100 kHz)			-36	dBm
•	174 - 230 MHz (BW = 100 kHz)			-54	dBm
•	230 - 470 MHz (BW = 100 kHz)			-36	dBm
•	470 - 862 MHz (BW = 100 kHz)			-54	dBm
•	862 - 1000 MHz (BW = 100 kHz)			-36	dBm
•	1000 - 12750 MHz (BW = 1 MHz)			-30	dBm
Rx Characteristics		Minimum	Typical	Maximum	Unit
Minimum Input Level (PER ≤ 10%)				-69	dBm
Maximum Input Level (PER < 10%)		-20			dBm
Adjacent Channel Rejection (PER ≤ 10%)		-2			dB

12.5 DC/RF Characteristics for IEEE 802.11a - 5 GHz

Table 35: DC/RF Characteristics for IEEE 802.11a - 5 GHz

Items	Contents
Specification	IEEE 802.11a
Mode	OFDM
Channel Frequency	5180 to 5240 MHz 5260 to 5320 MHz, 5500 to 5720 MHz 5745 to 5825 MHz
Data rate	6, 9, 12, 18, 24, 36, 48, 54 Mbps

12.5.1 High-Rate Condition for IEEE 802.11a - 5 GHz

Conditions: 25 °C, VDD33 = 3.3V, VDD18 = 1.8V VIO = 1.8V, Output power setting = 16 dBm, 54 Mbps mode

Table 36: High-Rate Condition for IEEE 802.11a - 5 GHz

Items		Contents			
DC Characteristics		Minimum	Typical	Maximum	Unit
DC current					
• Tx mode	VDD18		400		mA
	VDD33		230		mA
	VDD18 (MIMO)		620		mA
	VDD33 (MIMO)		460		mA
• Rx mode	VDD18		320		mA
	VDD33		0.2		mA
	VDD18 (MIMO)		320		mA
	VDD33 (MIMO)		0.2		mA
Tx Characteristics		Minimum	Typical	Maximum	Unit
Output Power		14	16	18	dBm
Spectrum Mask Margin					
•	9 MHz to 11 MHz (0 ~ -20 dBr)	0			dB
•	11 MHz to 20 MHz (-20 ~ -28 dBr)	0			dB
•	20 MHz to 30 MHz (-28 ~ -45 dBr)	0			dB
•	30 MHz to 33 MHz (-45 dBr)	0			dB
Constellation Error (EVM) (Measured at enhanced mode)				-25	dB
Frequency Tolerance		-20		20	ppm
Spurious Emissions					
•	30 - 47 MHz (BW = 100 kHz)			-36	dBm
•	47 - 74 MHz (BW = 100 kHz)			-54	dBm
•	74 - 87.5 MHz (BW = 100 kHz)			-36	dBm
•	87.5 - 118 MHz (BW = 100 kHz)			-54	dBm
•	118 - 174 MHz (BW = 100 kHz)			-36	dBm
•	174 - 230 MHz (BW = 100 kHz)			-54	dBm
•	230 - 470 MHz (BW = 100 kHz)			-36	dBm
•	470 - 862 MHz (BW = 100 kHz)			-54	dBm
•	862 - 1000 MHz (BW = 100 kHz)			-36	dBm

Items	Contents			
• 1000 - 5150 MHz (BW = 1 MHz)			-30	dBm
• 5350 - 5470 MHz (BW = 1 MHz)			-30	dBm
• 5725 - 26000 MHz (BW = 1 MHz)			-30	dBm
Rx Characteristics	Minimum	Typical	Maximum	Unit
Minimum Input Level (PER ≤ 10%)			-65	dBm
Maximum Input Level (PER < 10%)	-30			dBm
Adjacent Channel Rejection (PER ≤ 10%)	-1			dB

12.5.2 Low-Rate Condition for IEEE 802.11a - 5 GHz

Conditions: 25 °C, VDD33 = 3.3V, VDD18 = 1.8V VIO = 1.8V, Output power setting = 17 dBm, 6 Mbps mode

Table 37: Low-Rate Condition for IEEE 802.11a - 5 GHz

Items	Contents			
DC Characteristics	Minimum	Typical	Maximum	Unit
DC current				
• Tx mode	VDD18	430		mA
	VDD33	260		mA
	VDD18 (MIMO)	610		mA
	VDD33 (MIMO)	510		mA
• Rx mode	VDD18	320		mA
	VDD33	0.2		mA
	VDD18 (MIMO)	320		mA
	VDD33 (MIMO)	0.2		mA
Tx Characteristics	Minimum	Typical	Maximum	Unit
Output Power	15	17	19	dBm
Spectrum Mask Margin				
• 9 MHz to 11 MHz (0 ~ -20 dBr)	0			dB
• 11 MHz to 20 MHz (-20 ~ -28 dBr)	0			dB
• 20 MHz to 30 MHz (-28 ~ -45 dBr)	0			dB
• 30 MHz to 33 MHz (-45 dBr)	0			dB
Constellation Error (EVM) (Measured at enhanced mode)			-25	dB
Frequency Tolerance	-20		20	ppm
Spurious Emissions				
• 30 - 47 MHz (BW = 100 kHz)			-36	dBm
• 47 - 74 MHz (BW = 100 kHz)			-54	dBm
• 74 - 87.5 MHz (BW = 100 kHz)			-36	dBm
• 87.5 - 118 MHz (BW = 100 kHz)			-54	dBm
• 118 - 174 MHz (BW = 100 kHz)			-36	dBm
• 174 - 230 MHz (BW = 100 kHz)			-54	dBm
• 230 - 470 MHz (BW = 100 kHz)			-36	dBm
• 470 - 862 MHz (BW = 100 kHz)			-54	dBm
• 862 - 1000 MHz (BW = 100 kHz)			-36	dBm
• 1000 - 5150 MHz (BW = 1 MHz)			-30	dBm
• 5350 - 5470 MHz (BW = 1 MHz)			-30	dBm
• 5725 - 26000 MHz (BW = 1 MHz)			-30	dBm
- Rx Characteristics -	Minimum	Typical	Maximum	Unit

Items	Contents			
Minimum Input Level (PER ≤ 10%)			-82	dBm
Maximum Input Level (PER < 10%)	-30			dBm
Adjacent Channel Rejection (PER ≤ 10%)	-1			dB

12.6 DC/RF Characteristics for IEEE 802.11n (HT20) - 5 GHz

Table 38: DC/RF Characteristics for IEEE 802.11n(HT20) - 5 GHz

Items	Contents
Specification	IEEE 802.11n
Mode	OFDM
Channel Frequency	5180 to 5240 MHz 5260 to 5320 MHz 5500 to 5720 MHz 5745 to 5825 MHz
Data rate	MCS0 - MCS7

12.6.1 High-Rate Condition for IEEE 802.11n (HT20) - 5 GHz

Conditions: 25 °C, VDD33 = 3.3V, VDD18 = 1.8V VIO = 1.8V, Output power setting = 16 dBm, MCS7 mode

Table 39: High-Rate Condition for IEEE 802.11n (HT20) - 5 GHz

Items		Contents			
DC Characteristics		Minimum	Typical	Maximum	Unit
DC current					
• Tx mode	VDD18		400		mA
	VDD33		240		mA
	VDD18 (MIMO)		620		mA
	VDD33 (MIMO)		450		mA
• Rx mode	VDD18		320		mA
	VDD33		0.2		mA
	VDD18 (MIMO)		320		mA
	VDD33 (MIMO)		0.2		mA
Tx Characteristics		Minimum	Typical	Maximum	Unit
Output Power		14	16	18	dBm
Spectrum Mask Margin					
• 9 MHz to 11 MHz (0 ~ -20 dBr)		0			dB
• 11 MHz to 20 MHz (-20 ~ -28 dBr)		0			dB
• 20 MHz to 30 MHz (-28 ~ -45 dBr)		0			dB
• 30 MHz to 33 MHz (-45 dBr)		0			dB
Constellation Error (EVM) (Measured at enhanced mode)				-27	dB
Frequency Tolerance		-20		20	ppm
Spurious Emissions					
• 30 - 47 MHz (BW = 100 kHz)				-36	dBm

Items	Contents			
• 47 - 74 MHz (BW = 100 kHz)			-54	dBm
• 74 - 87.5 MHz (BW = 100 kHz)			-36	dBm
• 87.5 - 118 MHz (BW = 100 kHz)			-54	dBm
• 118 - 174 MHz (BW = 100 kHz)			-36	dBm
• 174 - 230 MHz (BW = 100 kHz)			-54	dBm
• 230 - 470 MHz (BW = 100 kHz)			-36	dBm
• 470 - 862 MHz (BW = 100 kHz)			-54	dBm
• 862 - 1000 MHz (BW = 100 kHz)			-36	dBm
• 1000 - 5150 MHz (BW = 1 MHz)			-30	dBm
• 5350 - 5470 MHz (BW = 1 MHz)			-30	dBm
• 5725 - 26000 MHz (BW = 1 MHz)			-30	dBm
Rx Characteristics	Minimum	Typical	Maximum	Unit
Minimum Input Level (PER ≤ 10%)			-64	dBm
Maximum Input Level (PER < 10%)	-30			dBm
Adjacent Channel Rejection (PER ≤ 10%)	-2			dB

12.6.2 Low-Rate Condition for IEEE 802.11n (HT20) - 5 GHz

Conditions: 25 °C, VDD33 = 3.3V, VDD18 = 1.8V VIO = 1.8V, Output power setting = 16 dBm, MCS0 mode

Table 40: Low-Rate Condition for IEEE 802.11n (HT20) - 5 GHz

Items	Contents			
DC Characteristics	Minimum	Typical	Maximum	Unit
DC current				
• Tx mode	VDD18	400		mA
	VDD33	250		mA
	VDD18 (MIMO)	630		mA
	VDD33 (MIMO)	470		mA
• Rx mode	VDD18	320		mA
	VDD33	0.2		mA
	VDD18 (MIMO)	320		mA
	VDD33 (MIMO)	0.2		mA
Tx Characteristics	Minimum	Typical	Maximum	Unit
Output Power	14	16	18	dBm
Spectrum Mask Margin				
• 9 MHz to 11 MHz (0 ~ -20 dBr)	0			dB
• 11 MHz to 20 MHz (-20 ~ -28 dBr)	0			dB
• 20 MHz to 30 MHz (-28 ~ -45 dBr)	0			dB
• 30 MHz to 33 MHz (-45 dBr)	0			dB
Constellation Error (EVM) (Measured at enhanced mode)			-27	dB
Frequency Tolerance	-20		20	ppm
Spurious Emissions				
• 30 - 47 MHz (BW = 100 kHz)			-36	dBm
• 47 - 74 MHz (BW = 100 kHz)			-54	dBm
• 74 - 87.5 MHz (BW = 100 kHz)			-36	dBm
• 87.5 - 118 MHz (BW = 100 kHz)			-54	dBm
• 118 - 174 MHz (BW = 100 kHz)			-36	dBm

Items	Contents			
• 174 - 230 MHz (BW = 100 kHz)			-54	dBm
• 230 - 470 MHz (BW = 100 kHz)			-36	dBm
• 470 - 862 MHz (BW = 100 kHz)			-54	dBm
• 862 - 1000 MHz (BW = 100 kHz)			-36	dBm
• 1000 - 5150 MHz (BW = 1 MHz)			-30	dBm
• 5350 - 5470 MHz (BW = 1 MHz)			-30	dBm
• 5725 - 26000 MHz (BW = 1 MHz)			-30	dBm
Rx Characteristics	Minimum	Typical	Maximum	Unit
Minimum Input Level (PER ≤ 10%)			-82	dBm
Maximum Input Level (PER < 10%)	-30			dBm
Adjacent Channel Rejection (PER ≤ 10%)	-2			dB

12.7 DC/RF Characteristics for IEEE 802.11ac (VHT20) - 5 GHz

Table 41: DC/RF Characteristics for IEEE 802.11ac (VHT20) - 5 GHz

Items	Contents
Specification	IEEE 802.11ac
Mode	OFDM
Channel Frequency	5180 to 5240 MHz 5260 to 5320 MHz 5500 to 5720 MHz 5745 to 5825 MHz
Data rate	MCS0 - MCS8

12.7.1 High-Rate Condition for IEEE 802.11ac (VHT20) - 5 GHz

Conditions: 25 °C, VDD33 = 3.3V, VDD18 = 1.8V VIO = 1.8V, Output power setting = 15 dBm, MCS8 mode

Table 42: High-Rate Condition for IEEE 802.11ac (VHT20) - 5 GHz

Items	Contents			
DC Characteristics	Minimum	Typical	Maximum	Unit
DC current				
• Tx mode	VDD18	370		mA
	VDD33	220		mA
	VDD18 (MIMO)	560		mA
	VDD33 (MIMO)	420		mA
• Rx mode	VDD18	320		mA
	VDD33	0.2		mA
	VDD18 (MIMO)	320		mA
	VDD33 (MIMO)	0.2		mA
Tx Characteristics	Minimum	Typical	Maximum	Unit
Output Power	13	15	17	dBm
Spectrum Mask Margin				
• 9 MHz to 11 MHz (0 ~ -20 dBr)	0			dB

Items	Contents			
• 11 MHz to 20 MHz (-20 ~ -28 dBr)	0			dB
• 20 MHz to 30 MHz (-28 ~ -45 dBr)	0			dB
• 30 MHz to 33 MHz (-45 dBr)	0			dB
Constellation Error (EVM) (Measured at enhanced mode)			-30	dB
Frequency Tolerance	-20		20	ppm
Spurious Emissions				
• 30 - 47 MHz (BW = 100 kHz)			-36	dBm
• 47 - 74 MHz (BW = 100 kHz)			-54	dBm
• 74 - 87.5 MHz (BW = 100 kHz)			-36	dBm
• 87.5 - 118 MHz (BW = 100 kHz)			-54	dBm
• 118 - 174 MHz (BW = 100 kHz)			-36	dBm
• 174 - 230 MHz (BW = 100 kHz)			-54	dBm
• 230 - 470 MHz (BW = 100 kHz)			-36	dBm
• 470 - 862 MHz (BW = 100 kHz)			-54	dBm
• 862 - 1000 MHz (BW = 100 kHz)			-36	dBm
• 1000 - 5150 MHz (BW = 1 MHz)			-30	dBm
• 5350 - 5470 MHz (BW = 1 MHz)			-30	dBm
• 5725 - 26000 MHz (BW = 1 MHz)			-30	dBm
Rx Characteristics	Minimum	Typical	Maximum	Unit
Minimum Input Level (PER ≤ 10%)			-59	dBm
Maximum Input Level (PER < 10%)	-30			dBm
Adjacent Channel Rejection (PER ≤ 10%)	-7			dB

12.7.2 Low-Rate Condition for IEEE 802.11ac (VHT20) - 5 GHz

Conditions: 25 °C, VDD33 = 3.3V, VDD18 = 1.8V VIO = 1.8V, Output power setting = 16 dBm, MCS0 mode

Table 43: Low-Rate Condition for IEEE 802.11ac (VHT20) - 5 GHz

Items		Contents			
DC Characteristics		Minimum	Typical	Maximum	Unit
DC current					
• Tx mode	VDD18		400		mA
	VDD33		250		mA
	VDD18 (MIMO)		640		mA
	VDD33 (MIMO)		470		mA
• Rx mode	VDD18		320		mA
	VDD33		0.2		mA
	VDD18 (MIMO)		320		mA
	VDD33 (MIMO)		0.2		mA
Tx Characteristics -		Minimum	Typical	Maximum	Unit
Output Power		14	16	18	dBm
Spectrum Mask Margin					
• 9 MHz to 11 MHz (0 ~ -20 dBr)		0			dB
• 11 MHz to 20 MHz (-20 ~ -28 dBr)		0			dB
• 20 MHz to 30 MHz (-28 ~ -45 dBr)		0			dB
• 30 MHz to 33 MHz (-45 dBr)		0			dB
Constellation Error (EVM)				-30	dB

Items	Contents			
(Measured at enhanced mode)				
Frequency Tolerance	-20		20	ppm
Spurious Emissions				
• 30 - 47 MHz (BW = 100 kHz)			-36	dBm
• 47 - 74 MHz (BW = 100 kHz)			-54	dBm
• 74 - 87.5 MHz (BW = 100 kHz)			-36	dBm
• 87.5 - 118 MHz (BW = 100 kHz)			-54	dBm
• 118 - 174 MHz (BW = 100 kHz)			-36	dBm
• 174 - 230 MHz (BW = 100 kHz)			-54	dBm
• 230 - 470 MHz (BW = 100 kHz)			-36	dBm
• 470 - 862 MHz (BW = 100 kHz)			-54	dBm
• 862 - 1000 MHz (BW = 100 kHz)			-36	dBm
• 1000 - 5150 MHz (BW = 1 MHz)			-30	dBm
• 5350 - 5470 MHz (BW = 1 MHz)			-30	dBm
• 5725 - 26000 MHz (BW = 1 MHz)			-30	dBm
Rx Characteristics	Minimum	Typical	Maximum	Unit
Minimum Input Level (PER ≤ 10%)			-82	dBm
Maximum Input Level (PER < 10%)	-30			dBm
Adjacent Channel Rejection (PER ≤ 10%)	-7			dB

12.8 DC/RF Characteristics for IEEE 802.11n (HT40) - 5 GHz

Table 44: DC/RF Characteristics for IEEE 802.11n (HT40) - 5 GHz

Items	Contents
Specification	IEEE 802.11n
Mode	OFDM
Channel Frequency	5190 - 5795 MHz
Data rate	MCS0 - MCS7

12.8.1 High-Rate Condition for IEEE 802.11n (HT40) - 5 GHz

Conditions: 25 °C, VDD33 = 3.3V, VDD18 = 1.8V VIO = 1.8V, Output power setting = 16 dBm, MCS7 mode

Table 45: High-Rate Condition for IEEE 802.11n (HT40) - 5 GHz

Items		Contents			
DC Characteristics		Minimum	Typical	Maximum	Unit
DC current					
• Tx mode	VDD18		410		mA
	VDD33		240		mA
	VDD18 (MIMO)		630		mA
	VDD33 (MIMO)		440		mA
• Rx mode	VDD18		320		mA
	VDD33		0.2		mA
	VDD18 (MIMO)		350		mA
	VDD33 (MIMO)		0.2		mA
Tx Characteristics		Minimum	Typical	Maximum	Unit
Output Power		14	16	18	dBm
Spectrum Mask Margin					
•	19 MHz to 21 MHz (0 ~ -20 dBr)	0			dB
•	21 MHz to 40 MHz (-20 ~ -28 dBr)	0			dB
•	40 MHz to 60 MHz (-28 ~ -45 dBr)	0			dB
•	60 MHz to 80 MHz (-45 dBr)	0			dB
Constellation Error (EVM) (Measured at enhanced mode)				-27	dB
Frequency Tolerance		-20		20	ppm
Spurious Emissions					
•	30 - 47 MHz (BW = 100 kHz)			-36	dBm
•	47 - 74 MHz (BW = 100 kHz)			-54	dBm
•	74 - 87.5 MHz (BW = 100 kHz)			-36	dBm
•	87.5 - 118 MHz (BW = 100 kHz)			-54	dBm
•	118 - 174 MHz (BW = 100 kHz)			-36	dBm
•	174 - 230 MHz (BW = 100 kHz)			-54	dBm
•	230 - 470 MHz (BW = 100 kHz)			-36	dBm
•	470 - 862 MHz (BW = 100 kHz)			-54	dBm
•	862 - 1000 MHz (BW = 100 kHz)			-36	dBm

Items	Contents			
• 1000 - 5150 MHz (BW = 1 MHz)			-30	dBm
• 5350 - 5470 MHz (BW = 1 MHz)			-30	dBm
• 5725 - 26000 MHz (BW = 1 MHz)			-30	dBm
Rx Characteristics	Minimum	Typical	Maximum	Unit
Minimum Input Level (PER ≤ 10%)			-61	dBm
Maximum Input Level (PER ≤ 10%)	-30			dBm
Adjacent Channel Rejection (PER ≤ 10%)	-2			dB

12.8.2 Low-Rate Condition for IEEE 802.11n (HT40) - 5 GHz

Conditions: 25 °C, VDD33 = 3.3V, VDD18 = 1.8V VIO = 1.8V, Output power setting = 16 dBm, MCS0 mode

Table 46: Low-Rate Condition for IEEE 802.11n (HT40) - 5 GHz

Items	Contents			
- DC Characteristics -	Minimum	Typical	Maximum	Unit
DC current				
• Tx mode	VDD18	410		mA
	VDD33	250		mA
	VDD18 (MIMO)	650		mA
	VDD33 (MIMO)	470		mA
• Rx mode	VDD18	320		mA
	VDD33	0.2		mA
	VDD18 (MIMO)	350		mA
	VDD33 (MIMO)	0.2		mA
Tx Characteristics	Minimum	Typical	Maximum	Unit
Output Power	14	16	18	dBm
Spectrum Mask Margin				
• 19 MHz to 21 MHz (0 ~ -20 dBr)	0			dB
• 21 MHz to 40 MHz (-20 ~ -28 dBr)	0			dB
• 40 MHz to 60 MHz (-28 ~ -45 dBr)	0			dB
• 60 MHz to 80 MHz (-45 dBr)	0			dB
Constellation Error (EVM) (Measured at enhanced mode)			-27	dB
Frequency Tolerance	-20		20	ppm
Spurious Emissions				
• 30 - 47 MHz (BW = 100 kHz)			-36	dBm
• 47 - 74 MHz (BW = 100 kHz)			-54	dBm
• 74 - 87.5 MHz (BW = 100 kHz)			-36	dBm
• 87.5 - 118 MHz (BW = 100 kHz)			-54	dBm
• 118 - 174 MHz (BW = 100 kHz)			-36	dBm
• 174 - 230 MHz (BW = 100 kHz)			-54	dBm
• 230 - 470 MHz (BW = 100 kHz)			-36	dBm
• 470 - 862 MHz (BW = 100 kHz)			-54	dBm
• 862 - 1000 MHz (BW = 100 kHz)			-36	dBm
• 1000 - 5150 MHz (BW = 1 MHz)			-30	dBm
• 5350 - 5470 MHz (BW = 1 MHz)			-30	dBm
• 5725 - 26000 MHz (BW = 1 MHz)			-30	dBm
Rx Characteristics	Minimum	Typical	Maximum	Unit

Items	Contents			
Minimum Input Level (PER ≤ 10%)			-79	dBm
Maximum Input Level (PER ≤ 10%)	-30			dBm
Adjacent Channel Rejection (PER ≤ 10%)	-2			dB

12.9 DC/RF Characteristics for IEEE 802.11ac (VHT40) - 5 GHz

Table 47: DC/RF Characteristics for IEEE 802.11ac (VHT40) - 5 GHz

Items	Contents
Specification	IEEE 802.11ac
Mode	OFDM
Channel Frequency	5190 to 5795 MHz
Data rate	MCS0 - MCS9

12.9.1 High-Rate Condition for IEEE 802.11ac (VHT40) - 5 GHz

Conditions: 25 °C, VDD33 = 3.3V, VDD18 = 1.8V VIO = 1.8V, Output power setting = 15 dBm, MCS9 mode

Table 48: High-Rate Condition for IEEE 802.11ac (VHT40) - 5 GHz

Items		Contents			
DC Characteristics		Minimum	Typical	Maximum	Unit
DC current					
• Tx mode	VDD18		380		mA
	VDD33		210		mA
	VDD18 (MIMO)		570		mA
	VDD33 (MIMO)		410		mA
• Rx mode	VDD18		320		mA
	VDD33		0.2		mA
	VDD18 (MIMO)		350		mA
	VDD33 (MIMO)		0.2		mA
Tx Characteristics		Minimum	Typical	Maximum	Unit
Output Power		13	15	17	dBm
Spectrum Mask Margin					
• 19 MHz to 21 MHz (0 ~ -20 dBr)		0			dB
• 21 MHz to 40 MHz (-20 ~ -28 dBr)		0			dB
• 40 MHz to 60 MHz (-28 ~ -45 dBr)		0			dB
• 60 MHz to 80 MHz (-45 dBr)		0			dB
Constellation Error (EVM) (Measured at enhanced mode)				-32	dB
Frequency Tolerance		-20		20	ppm
Spurious Emissions					
• 30 - 47 MHz (BW = 100 kHz)				-36	dBm
• 47 - 74 MHz (BW = 100 kHz)				-54	dBm
• 74 - 87.5 MHz (BW = 100 kHz)				-36	dBm

Items	Contents			
• 87.5 - 118 MHz (BW = 100 kHz)			-54	dBm
• 118 - 174 MHz (BW = 100 kHz)			-36	dBm
• 174 - 230 MHz (BW = 100 kHz)			-54	dBm
• 230 - 470 MHz (BW = 100 kHz)			-36	dBm
• 470 - 862 MHz (BW = 100 kHz)			-54	dBm
• 862 - 1000 MHz (BW = 100 kHz)			-36	dBm
• 1000 - 5150 MHz (BW = 1 MHz)			-30	dBm
• 5350 - 5470 MHz (BW = 1 MHz)			-30	dBm
• 5725 - 26000 MHz (BW = 1 MHz)			-30	dBm
Rx Characteristics	Minimum	Typical	Maximum	Unit
Minimum Input Level (PER ≤ 10%)			-54	dBm
Maximum Input Level (PER ≤ 10%)	-30			dBm
Adjacent Channel Rejection (PER ≤ 10%)	-9			dB

12.9.2 Low-Rate Condition for IEEE 802.11ac (VHT40) - 5 GHz

Conditions: 25 °C, VDD33 = 3.3V, VDD18 = 1.8V VIO = 1.8V, Output power setting = 16 dBm, MCS0 mode

Table 49: Low-Rate Condition for IEEE 802.11ac (VHT40) - 5 GHz

Items		Contents			
DC Characteristics		Minimum	Typical	Maximum	Unit
DC Current					
• Tx mode	VDD18		410		mA
	VDD33		250		mA
	VDD18 (MIMO)		650		mA
	VDD33 (MIMO)		470		mA
• Rx mode	VDD18		320		mA
	VDD33		0.2		mA
	VDD18 (MIMO)		350		mA
	VDD33 (MIMO)		0.2		mA
Tx Characteristics		Minimum	Typical	Maximum	Unit
Output Power		14	16	18	dBm
Spectrum Mask Margin					
•	19 MHz to 21 MHz (0 ~ -20 dBr)	0			dB
•	21 MHz to 40 MHz (-20 ~ -28 dBr)	0			dB
•	40 MHz to 60 MHz (-28 ~ -45 dBr)	0			dB
•	60 MHz to 80 MHz (-45 dBr)	0			dB
Constellation Error (EVM) (Measured at enhanced mode)				-32	dB
Frequency Tolerance		-20		20	ppm
Spurious Emissions					
•	30 - 47 MHz (BW = 100 kHz)			-36	dBm
•	47 - 74 MHz (BW = 100 kHz)			-54	dBm
•	74 - 87.5 MHz (BW = 100 kHz)			-36	dBm
•	87.5 - 118 MHz (BW = 100 kHz)			-54	dBm
•	118 - 174 MHz (BW = 100 kHz)			-36	dBm
•	174 - 230 MHz (BW = 100 kHz)			-54	dBm
•	230 - 470 MHz (BW = 100 kHz)			-36	dBm

Items	Contents			
• 470 - 862 MHz (BW = 100 kHz)			-54	dBm
• 862 - 1000 MHz (BW = 100 kHz)			-36	dBm
• 1000 - 5150 MHz (BW = 1 MHz)			-30	dBm
• 5350 - 5470 MHz (BW = 1 MHz)			-30	dBm
• 5725 - 26000 MHz (BW = 1 MHz)			-30	dBm
Rx Characteristics	Minimum	Typical	Maximum	Unit
Minimum Input Level (PER ≤ 10%)			-79	dBm
Maximum Input Level (PER ≤ 10%)	-30			dBm
Adjacent Channel Rejection (PER ≤ 10%)	-9			dB

12.10 DC/RF Characteristics for IEEE 802.11ac (VHT80) - 5 GHz

Table 50: DC/RF Characteristics for IEEE 802.11ac (VHT80) - 5 GHz

Items	Contents
Specification	IEEE 802.11ac
Mode	OFDM
Channel Frequency	5210 - 5775 MHz
Data rate	MCS0 - MCS9

12.10.1 High-Rate Condition for IEEE 802.11ac (VHT80) - 5 GHz

Conditions: 25 °C, VDD33 = 3.3V, VDD18 = 1.8V VIO = 1.8V, Output power setting = 14 dBm, MCS9 mode

Table 51: High-Rate Condition for IEEE 802.11ac (VHT80) - 5 GHz

Items	Contents			
DC Characteristics	Minimum	Typical	Maximum	Unit
DC current				
• Tx mode	VDD18	400		mA
	VDD33	200		mA
	VDD18 (MIMO)	600		mA
	VDD33 (MIMO)	380		mA
• Rx mode	VDD18	350		mA
	VDD33	0.2		mA
	VDD18 (MIMO)	420		mA
	VDD33 (MIMO)	0.2		mA
Tx Characteristics	Minimum	Typical	Maximum	Unit
Output Power	12	14	16	dBm
Spectrum Mask Margin				
• 39 MHz to 41 MHz (0 ~ -20 dBr)	0			dB
• 41 MHz to 80 MHz (-20 ~ -28 dBr)	0			dB
• 80 MHz to 120 MHz (-28 ~ -40 dBr)	0			dB
• 120 MHz to 140 MHz (-40 dBr)	0			dB

Items	Contents			
Constellation Error (EVM) (Measured at enhanced mode)			-32	dB
Frequency Tolerance	-20		20	ppm
Spurious Emissions				
• 30 - 47 MHz (BW = 100 kHz)			-36	dBm
• 47 - 74 MHz (BW = 100 kHz)			-54	dBm
• 74 - 87.5 MHz (BW = 100 kHz)			-36	dBm
• 87.5 - 118 MHz (BW = 100 kHz)			-54	dBm
• 118 - 174 MHz (BW = 100 kHz)			-36	dBm
• 174 - 230 MHz (BW = 100 kHz)			-54	dBm
• 230 - 470 MHz (BW = 100 kHz)			-36	dBm
• 470 - 862 MHz (BW = 100 kHz)			-54	dBm
• 862 - 1000 MHz (BW = 100 kHz)			-36	dBm
• 1000 - 5150 MHz (BW = 1 MHz)			-30	dBm
• 5350 - 5470 MHz (BW = 1 MHz)			-30	dBm
• 5725 - 26000 MHz (BW = 1 MHz)			-30	dBm
Rx Characteristics	Minimum	Typical	Maximum	Unit
Minimum Input Level (PER ≤ 10%)			-51	dBm
Maximum Input Level (PER ≤ 10%)	-30			dBm
Adjacent Channel Rejection (PER ≤ 10%)	-9			dB

12.10.2 Low-Rate Condition for IEEE 802.11ac (VHT80) - 5 GHz

Conditions: 25 °C, VDD33 = 3.3V, VDD18 = 1.8V VIO = 1.8V, Output power setting = 15 dBm, MCS0 mode

Table 52: Low-Rate Condition for IEEE 802.11ac (VHT80) - 5 GHz

Items	Contents			
DC Characteristics	Minimum	Typical	Maximum	Unit
DC current				
• Tx mode	VDD18	400		mA
	VDD33	230		mA
	VDD18 (MIMO)	630		mA
	VDD33 (MIMO)	440		mA
• Rx mode	VDD18	350		mA
	VDD33	0.2		mA
	VDD18 (MIMO)	420		mA
	VDD33 (MIMO)	0.2		mA
Tx Characteristics	Minimum	Typical	Maximum	Unit
Output Power	13	15	17	dBm
Spectrum Mask Margin				
• 39 MHz to 41 MHz (0 ~ -20 dBr)	0			dB
• 41 MHz to 80 MHz (-20 ~ -28 dBr)	0			dB
• 80 MHz to 120 MHz (-28 ~ -40 dBr)	0			dB
• 120 MHz to 140 MHz (-40 dBr)	0			dB
Constellation Error (EVM) (Measured at enhanced mode)			-19	dB
Frequency Tolerance	-20		20	ppm

Items	Contents			
Spurious Emissions				
• 30 - 47 MHz (BW = 100 kHz)			-36	dBm
• 47 - 74 MHz (BW = 100 kHz)			-54	dBm
• 74 - 87.5 MHz (BW = 100 kHz)			-36	dBm
• 87.5 - 118 MHz (BW = 100 kHz)			-54	dBm
• 118 - 174 MHz (BW = 100 kHz)			-36	dBm
• 174 - 230 MHz (BW = 100 kHz)			-54	dBm
• 230 - 470 MHz (BW = 100 kHz)			-36	dBm
• 470 - 862 MHz (BW = 100 kHz)			-54	dBm
• 862 - 1000 MHz (BW = 100 kHz)			-36	dBm
• 1000 - 5150 MHz (BW = 1 MHz)			-30	dBm
• 5350 - 5470 MHz (BW = 1 MHz)			-30	dBm
• 5725 - 26000 MHz (BW = 1 MHz)			-30	dBm
Rx Characteristics	Minimum	Typical	Maximum	Unit
Minimum Input Level (PER ≤ 10%)			-76	dBm
Maximum Input Level (PER ≤ 10%)	-30			dBm
Adjacent Channel Rejection (PER ≤ 10%)	-9			dB

12.11 DC/RF Characteristics for IEEE 802.11ax (HE20) - 5 GHz

Table 53: DC/RF Characteristics for IEEE 802.11ax (HE20) - 5 GHz

Items	Contents
Specification	IEEE 802.11ax
Mode	OFDM
Channel Frequency	5180 to 5240 MHz 5260 to 5320 MHz 5500 to 5720 MHz 5745 to 5825 MHz
Data rate	MCS0 - MCS11

12.11.1 High-Rate Condition for IEEE 802.11ax (HE20) - 5 GHz

Conditions: 25 °C, VDD33 = 3.3V, VDD18 = 1.8V VIO = 1.8V, Output power setting = 14 dBm, MCS11 mode

Table 54: High-Rate Condition for IEEE 802.11ax (HE20) - 5 GHz

Items		Contents			
DC Characteristics		Minimum	Typical	Maximum	Unit
DC current					
• Tx mode	VDD18		380		mA
	VDD33		210		mA
	VDD18 (MIMO)		560		mA
	VDD33 (MIMO)		400		mA
• Rx mode	VDD18		320		mA
	VDD33		0.2		mA
	VDD18 (MIMO)		320		mA
	VDD33 (MIMO)		0.2		mA
Tx Characteristics		Minimum	Typical	Maximum	Unit
Output Power		12	14	16	dBm
Spectrum Mask Margin					
• 39 MHz to 41 MHz (0 ~ -20 dBr)		0			dB
• 41 MHz to 80 MHz (-20 ~ -28 dBr)		0			dB
• 80 MHz to 120 MHz (-28 ~ -40 dBr)		0			dB
• 120 MHz to 140 MHz (-40 dBr)		0			dB
Constellation Error (EVM) (Measured at enhanced mode)				-32	dB
Frequency Tolerance		-20		20	ppm
Spurious Emissions					
• 30 - 47 MHz (BW = 100 kHz)				-36	dBm
• 47 - 74 MHz (BW = 100 kHz)				-54	dBm
• 74 - 87.5 MHz (BW = 100 kHz)				-36	dBm
• 87.5 - 118 MHz (BW = 100 kHz)				-54	dBm
• 118 - 174 MHz (BW = 100 kHz)				-36	dBm
• 174 - 230 MHz (BW = 100 kHz)				-54	dBm
• 230 - 470 MHz (BW = 100 kHz)				-36	dBm
• 470 - 862 MHz (BW = 100 kHz)				-54	dBm
• 862 - 1000 MHz (BW = 100 kHz)				-36	dBm
• 1000 - 5150 MHz (BW = 1 MHz)				-30	dBm
• 5350 - 5470 MHz (BW = 1 MHz)				-30	dBm
• 5725 - 26000 MHz (BW = 1 MHz)				-30	dBm
Rx Characteristics		Minimum	Typical	Maximum	Unit
Minimum Input Level (PER ≤ 10%)				-51	dBm
Maximum Input Level (PER ≤ 10%)		-30			dBm
Adjacent Channel Rejection (PER ≤ 10%)		-9			dB

12.11.2 Low-Rate Condition for IEEE 802.11ax (HE20) - 5 GHz

Conditions: 25 °C, VDD33 = 3.3V, VDD18 = 1.8V VIO = 1.8V, Output power setting = 16 dBm, MCS0 mode

Table 55: Low-Rate Condition for IEEE 802.11ax (HE20) - 5 GHz

Items		Contents			
DC Characteristics		Minimum	Typical	Maximum	Unit
DC current					
• Tx mode	VDD18		400		mA
	VDD33		250		mA
	VDD18 (MIMO)		640		mA
	VDD33 (MIMO)		480		mA
• Rx mode	VDD18		320		mA
	VDD33		0.2		mA
	VDD18 (MIMO)		320		mA
	VDD33 (MIMO)		0.2		mA
Tx Characteristics		Minimum	Typical	Maximum	Unit
Output Power		14	16	18	dBm
Spectrum Mask Margin					
•	39 MHz to 41 MHz (0 ~ -20 dBr)	0			dB
•	41 MHz to 80 MHz (-20 ~ -28 dBr)	0			dB
•	80 MHz to 120 MHz (-28 ~ -40 dBr)	0			dB
•	120 MHz to 140 MHz (-40 dBr)	0			dB
Constellation Error (EVM) (Measured at enhanced mode)				-19	dB
Frequency Tolerance		-20		20	ppm
Spurious Emissions					
•	30 - 47 MHz (BW = 100 kHz)			-36	dBm
•	47 - 74 MHz (BW = 100 kHz)			-54	dBm
•	74 - 87.5 MHz (BW = 100 kHz)			-36	dBm
•	87.5 - 118 MHz (BW = 100 kHz)			-54	dBm
•	118 - 174 MHz (BW = 100 kHz)			-36	dBm
•	174 - 230 MHz (BW = 100 kHz)			-54	dBm
•	230 - 470 MHz (BW = 100 kHz)			-36	dBm
•	470 - 862 MHz (BW = 100 kHz)			-54	dBm
•	862 - 1000 MHz (BW = 100 kHz)			-36	dBm
•	1000 - 5150 MHz (BW = 1 MHz)			-30	dBm
•	5350 - 5470 MHz (BW = 1 MHz)			-30	dBm
•	5725 - 26000 MHz (BW = 1 MHz)			-30	dBm
Rx Characteristics		Minimum	Typical	Maximum	Unit
Minimum Input Level (PER ≤ 10%)				-76	dBm
Maximum Input Level (PER ≤ 10%)		-30			dBm
Adjacent Channel Rejection (PER ≤ 10%)		-9			dB

12.12 DC/RF Characteristics for IEEE 802.11ax (HE40) - 5 GHz

Table 56: DC/RF Characteristics for IEEE 802.11ax (HE40) - 5 GHz

Items	Contents
Specification	IEEE 802.11ax
Mode	OFDM
Channel Frequency	5210 - 5775 MHz
Data rate	MCS0 - MCS11

12.12.1 High-Rate Condition for IEEE 802.11ax (HE40) - 5 GHz

Conditions: 25 °C, VDD33 = 3.3V, VDD18 = 1.8V VIO = 1.8V, Output power setting = 14 dBm, MCS11 mode

Table 57: High-Rate Condition for IEEE 802.11ax (HE40) - 5 GHz

Items		Contents			
DC Characteristics		Minimum	Typical	Maximum	Unit
DC current					
• Tx mode	VDD18		390		mA
	VDD33		210		mA
	VDD18 (MIMO)		560		mA
	VDD33 (MIMO)		400		mA
• Rx mode	VDD18		320		mA
	VDD33		0.2		mA
	VDD18 (MIMO)		350		mA
	VDD33 (MIMO)		0.2		mA
Tx Characteristics		Minimum	Typical	Maximum	Unit
Output Power		12	14	16	dBm
Spectrum Mask Margin					
•	39 MHz to 41 MHz (0 ~ -20 dBr)	0			dB
•	41 MHz to 80 MHz (-20 ~ -28 dBr)	0			dB
•	80 MHz to 120 MHz (-28 ~ -40 dBr)	0			dB
•	120 MHz to 140 MHz (-40 dBr)	0			dB
Constellation Error (EVM) (Measured at enhanced mode)				-32	dB
Frequency Tolerance		-20		20	ppm
Spurious Emissions					
•	30 - 47 MHz (BW = 100 kHz)			-36	dBm
•	47 - 74 MHz (BW = 100 kHz)			-54	dBm
•	74 - 87.5 MHz (BW = 100 kHz)			-36	dBm
•	87.5 - 118 MHz (BW = 100 kHz)			-54	dBm
•	118 - 174 MHz (BW = 100 kHz)			-36	dBm
•	174 - 230 MHz (BW = 100 kHz)			-54	dBm
•	230 - 470 MHz (BW = 100 kHz)			-36	dBm
•	470 - 862 MHz (BW = 100 kHz)			-54	dBm

Items	Contents			
• 862 - 1000 MHz (BW = 100 kHz)			-36	dBm
• 1000 - 5150 MHz (BW = 1 MHz)			-30	dBm
• 5350 - 5470 MHz (BW = 1 MHz)			-30	dBm
• 5725 - 26000 MHz (BW = 1 MHz)			-30	dBm
Rx Characteristics	Minimum	Typical	Maximum	Unit
Minimum Input Level (PER ≤ 10%)			-51	dBm
Maximum Input Level (PER ≤ 10%)	-30			dBm
Adjacent Channel Rejection (PER ≤ 10%)	-9			dB

12.12.2 Low-Rate Condition for IEEE 802.11ax (HE40) - 5 GHz

Conditions: 25 °C, VDD33 = 3.3V, VDD18 = 1.8V VIO = 1.8V, Output power setting = 16 dBm, MCS0 mode

Table 58: Low-Rate Condition for IEEE 802.11ax (HE 40) - 5 GHz

Items	Contents			
DC Characteristics	Minimum	Typical	Maximum	Unit
DC current				
• Tx mode	VDD18	420		mA
	VDD33	250		mA
	VDD18 (MIMO)	660		mA
	VDD33 (MIMO)	480		mA
• Rx mode	VDD18	320		mA
	VDD33	0.2		mA
	VDD18 (MIMO)	350		mA
	VDD33 (MIMO)	0.2		mA
Tx Characteristics	Minimum	Typical	Maximum	Unit
Output Power	14	16	18	dBm
Spectrum Mask Margin				
• 39 MHz to 41 MHz (0 ~ -20 dBr)	0			dB
• 41 MHz to 80 MHz (-20 ~ -28 dBr)	0			dB
• 80 MHz to 120 MHz (-28 ~ -40 dBr)	0			dB
• 120 MHz to 140 MHz (-40 dBr)	0			dB
Constellation Error (EVM) (Measured at enhanced mode)			-32	dB
Frequency Tolerance	-20		20	ppm
Spurious Emissions				
• 30 - 47 MHz (BW = 100 kHz)			-36	dBm
• 47 - 74 MHz (BW = 100 kHz)			-54	dBm
• 74 - 87.5 MHz (BW = 100 kHz)			-36	dBm
• 87.5 - 118 MHz (BW = 100 kHz)			-54	dBm
• 118 - 174 MHz (BW = 100 kHz)			-36	dBm
• 174 - 230 MHz (BW = 100 kHz)			-54	dBm
• 230 - 470 MHz (BW = 100 kHz)			-36	dBm
• 470 - 862 MHz (BW = 100 kHz)			-54	dBm
• 862 - 1000 MHz (BW = 100 kHz)			-36	dBm
• 1000 - 5150 MHz (BW = 1 MHz)			-30	dBm

Items	Contents			
• 5350 - 5470 MHz (BW = 1 MHz)			-30	dBm
• 5725 - 26000 MHz (BW = 1 MHz)			-30	dBm
Rx Characteristics	Minimum	Typical	Maximum	Unit
Minimum Input Level (PER ≤ 10%)			-76	dBm
Maximum Input Level (PER ≤ 10%)	-30			dBm
Adjacent Channel Rejection (PER ≤ 10%)	-9			dB

12.13 DC/RF Characteristics for IEEE 802.11ax (HE80) - 5 GHz

Table 59: DC/RF Characteristics for IEEE 802.11ax (HE80) - 5 GHz

Items	Contents
Specification	IEEE 802.11ax
Mode	OFDM
Channel Frequency	5210 - 5775 MHz
Data rate	MCS0 - MCS11

12.13.1 High-Rate Condition for IEEE 802.11ax (HE80) - 5 GHz

Conditions: 25 °C, VDD33 = 3.3V, VDD18 = 1.8V VIO = 1.8V, Output power setting = 14 dBm, MCS11 mode

Table 60: High-Rate Condition for IEEE 802.11ax (HE80) - 5 GHz

Items		Contents			
DC Characteristics		Minimum	Typical	Maximum	Unit
DC current					
• Tx mode	VDD18		400		mA
	VDD33		200		mA
	VDD18 (MIMO)		600		mA
	VDD33 (MIMO)		400		mA
• Rx mode	VDD18		350		mA
	VDD33		0.2		mA
	VDD18 (MIMO)		420		mA
	VDD33 (MIMO)		0.2		mA
Tx Characteristics		Minimum	Typical	Maximum	Unit
Output Power		12	14	16	dBm
Spectrum Mask Margin					
• 39 MHz to 41 MHz (0 ~ -20 dBr)		0			dB
• 41 MHz to 80 MHz (-20 ~ -28 dBr)		0			dB
• 80 MHz to 120 MHz (-28 ~ -40 dBr)		0			dB
• 120 MHz to 140 MHz (-40 dBr)		0			dB
Constellation Error (EVM) (Measured at enhanced mode)				-32	dB

Items	Contents			
Frequency Tolerance	-20		20	ppm
Spurious Emissions				
• 30 - 47 MHz (BW = 100 kHz)			-36	dBm
• 47 - 74 MHz (BW = 100 kHz)			-54	dBm
• 74 - 87.5 MHz (BW = 100 kHz)			-36	dBm
• 87.5 - 118 MHz (BW = 100 kHz)			-54	dBm
• 118 - 174 MHz (BW = 100 kHz)			-36	dBm
• 174 - 230 MHz (BW = 100 kHz)			-54	dBm
• 230 - 470 MHz (BW = 100 kHz)			-36	dBm
• 470 - 862 MHz (BW = 100 kHz)			-54	dBm
• 862 - 1000 MHz (BW = 100 kHz)			-36	dBm
• 1000 - 5150 MHz (BW = 1 MHz)			-30	dBm
• 5350 - 5470 MHz (BW = 1 MHz)			-30	dBm
• 5725 - 26000 MHz (BW = 1 MHz)			-30	dBm
Rx Characteristics	Minimum	Typical	Maximum	Unit
Minimum Input Level (PER ≤ 10%)			-51	dBm
Maximum Input Level (PER ≤ 10%)	-30			dBm
Adjacent Channel Rejection (PER ≤ 10%)	-9			dB

12.13.2 Low-Rate Condition for IEEE 802.11ax (HE80) - 5 GHz

Conditions: 25 °C, VDD33 = 3.3V, VDD18 = 1.8V VIO = 1.8V, Output power setting = 15 dBm, MCS0 mode

Table 61: Low-Rate Condition for IEEE 802.11ax (HE80) - 5 GHz

Items		Contents			
DC Characteristics		Minimum	Typical	Maximum	Unit
DC current					
• Tx mode	VDD18		400		mA
	VDD33		230		mA
	VDD18 (MIMO)		640		mA
	VDD33 (MIMO)		440		mA
• Rx mode	VDD18		350		mA
	VDD33		0.2		mA
	VDD18 (MIMO)		420		mA
	VDD33 (MIMO)		0.2		mA
Tx Characteristics		Minimum	Typical	Maximum	Unit
Output Power		13	15	17	dBm
Spectrum Mask Margin					
• 39 MHz to 41 MHz (0 ~ -20 dBr)		0			dB
• 41 MHz to 80 MHz (-20 ~ -28 dBr)		0			dB
• 80 MHz to 120 MHz (-28 ~ -40 dBr)		0			dB
• 120 MHz to 140 MHz (-40 dBr)		0			dB
Constellation Error (EVM) (Measured at enhanced mode)				-32	dB
Frequency Tolerance		-20		20	ppm
Spurious Emissions					
• 30 - 47 MHz (BW = 100 kHz)				-36	dBm
• 47 - 74 MHz (BW = 100 kHz)				-54	dBm
• 74 - 87.5 MHz (BW = 100 kHz)				-36	dBm
• 87.5 - 118 MHz (BW = 100 kHz)				-54	dBm
• 118 - 174 MHz (BW = 100 kHz)				-36	dBm
• 174 - 230 MHz (BW = 100 kHz)				-54	dBm
• 230 - 470 MHz (BW = 100 kHz)				-36	dBm
• 470 - 862 MHz (BW = 100 kHz)				-54	dBm
• 862 - 1000 MHz (BW = 100 kHz)				-36	dBm
• 1000 - 5150 MHz (BW = 1 MHz)				-30	dBm
• 5350 - 5470 MHz (BW = 1 MHz)				-30	dBm
• 5725 - 26000 MHz (BW = 1 MHz)				-30	dBm
Rx Characteristics		Minimum	Typical	Maximum	Unit
Minimum Input Level (PER ≤ 10%)				-76	dBm
Maximum Input Level (PER ≤ 10%)		-30			dBm
Adjacent Channel Rejection (PER ≤ 10%)		-9			dB

12.14 DC/RF Characteristics for Bluetooth

12.14.1 Basic Data Rate Condition

Conditions: 25 °C, VDD33 = 3.3V, VDD18 = 1.8V VIO = 1.8V

Table 62: Basic Data Rate Condition

Items	Contents			
Bluetooth specification (power class)	Version 5.3			
Channel frequency (spacing)	2402 to 2480 MHz (1 MHz)			
Current Consumption	Minimum	Typical	Maximum	Unit
• Tx mode DH5	VDD18	45		mA
	VDD33	0.2		
• Rx mode DH5	VDD18	20		mA
	VDD33	0.2		
Tx Characteristics	Minimum	Typical	Maximum	Unit
Output Power@DH5	0	3	6	dBm
Frequency range	2400		2483.5	MHz
20 dB bandwidth			1	MHz
Adjacent Channel Power ³				
• [M-N] = 2			-20	dBm
• [M-N] ≥ 3			-40	dBm
Modulation characteristics				
• Modulation $\Delta f_{1\text{avg}}$	140	151	175	kHz
• Modulation $\Delta f_{2\text{max}}$	115			kHz
• Modulation $\Delta f_{2\text{avg}} / \Delta f_{1\text{avg}}$	0.8	1		
Carrier Frequency Drift				
• 1 slot	-25		25	kHz
• 3 slot / 5 slot	-40		40	kHz
• Maximum Drift Rate			20	kHz/50 μ s
Rx Characteristics	Minimum	Typical	Maximum	Unit
BDR Sensitivity (BER ≤ 0.1%)		-91	-86	dBm
C/I Performance (BER ≤ 0.1%) ⁴				
• co-channel			11	dB
• 1 MHz			0	dB
• 2 MHz			-30	dB
• 3 MHz			-40	dB
• image (+4 MHz)			-9	dB
• image +/- 1 MHz			-20	dB
Maximum Input Level (BER ≤ 0.1%)	-20			dBm

³ Up to three spurious responses within Bluetooth limits are allowed.

⁴ Up to five spurious responses within Bluetooth limits are allowed.

12.14.2 Enhanced Data Rate Condition

Conditions: 25 °C, VDD33 = 3.3V, VDD18 = 1.8V VIO = 1.8V

Table 63: Enhanced Data Rate Condition

Items	Contents			
Bluetooth Specification (power class)	Version 5.3			
Channel Frequency (spacing)	2402 to 2480 MHz (1 MHz)			
Current Consumption	Minimum	Typical	Maximum	Unit
• Tx mode 2DH5	VDD18	45		mA
	VDD33	0.2		
• Rx mode 2DH5	VDD18	20		mA
	VDD33	0.2		
• Tx mode 3DH5	VDD18	45		mA
	VDD33	0.2		
• Rx mode 3DH5	VDD18	20		mA
	VDD33	0.2		
Tx Characteristics	Minimum	Typical	Maximum	Unit
Output Power@2DH5/3DH5	-3	0	3	dBm
Frequency Range	2400		2483.5	MHz
20 dB bandwidth			1	MHz
Adjacent Channel Power ⁵				
• [M-N] = 2			-20	dBm
• [M-N] ≥ 3			-40	dBm
EDR Relative Power	-4		1	dB
EDR Carrier Frequency Stability and Modulation Accuracy				
• ω_i	-75		75	kHz
• $\omega_i + \omega_o$	-75		75	kHz
• ω_o	-10		10	kHz
• RMS DEVM (DQPSK)			20	%
• Peak DEVM (DQPSK)			35	%
• 99% DEVM (DQPSK)			30	%
• RMS DEVM (8DPSK)			13	%
• Peak DEVM (8DPSK)			25	%
• 99% DEVM (8DPSK)			20	%
Spurious Emissions				
• 30 - 47 MHz (BW = 100 kHz)			-36	dBm
• 47 - 74 MHz (BW = 100 kHz)			-54	dBm
• 74 - 87.5 MHz (BW = 100 kHz)			-36	dBm
• 87.5 - 118 MHz (BW = 100 kHz)			-54	dBm
• 118 - 174 MHz (BW = 100 kHz)			-36	dBm
• 174 - 230 MHz (BW = 100 kHz)			-54	dBm
• 230 - 470 MHz (BW = 100 kHz)			-36	dBm
• 470 - 862 MHz (BW = 100 kHz)			-54	dBm

⁵ Up to three spurious responses within Bluetooth limits are allowed.

Items	Contents			
• 862 - 1000 MHz (BW = 100 kHz)			-36	dBm
• 1000 - 12750 MHz (BW = 1 MHz)			-30	dBm
Rx Characteristics	Minimum	Typical	Maximum	Unit
EDR Sensitivity (BER ≤ 0.007%)@8DPSK		-88	-82	dBm
C/I Performance (BER ≤ 0.1%) ⁶				
• co-channel			11	dB
• 1 MHz			0	dB
• 2 MHz			-30	dB
• 3 MHz			-40	dB
• image (+4 MHz)			-9	dB
• image +/- 1 MHz			-20	dB
Maximum Input Level (BER ≤ 0.1%)	-20			dBm

12.15 DC/RF Characteristics for Bluetooth Low Energy

12.15.1 1 Mbps PHY Condition

Conditions: 25 °C, VDD33 = 3.3V, VDD18 = 1.8V VIO = 1.8V

Table 64: 1 Mbps PHY Condition

Items	Contents			
Bluetooth Specification (power class)	Version 5.3			
Channel Frequency (spacing)	2402 to 2480 MHz (2 MHz)			
Number of RF Channel	40			
Current Consumption	Minimum	Typical	Maximum	Unit
• Tx mode	VDD18	60		mA
	VDD33	0.2		
• Rx mode	VDD18	20		mA
	VDD33	0.2		
Tx Characteristics	Minimum	Typical	Maximum	Unit
Center Frequency	2402		2480	MHz
Channel Spacing		2		MHz
Number of RF channel		40		
Output Power	0	3	6	dBm
Modulation Characteristics				
• Δf_{1avg}	225		275	kHz
• Δf_{2max} (at 99.9%)	185			kHz
• $\Delta f_{2avg} / \Delta f_{1avg}$	0.8			
Carrier Frequency Offset and Drift				
• Frequency offset			150	kHz
• Frequency drift			50	kHz

⁶ Up to five spurious responses within Bluetooth limits are allowed.

Items	Contents			
• Drift rate			20	kHz
Spurious Emissions				
• 30 - 47 MHz (BW = 100 kHz)			-36	dBm
• 47 - 74 MHz (BW = 100 kHz)			-54	dBm
• 74 - 87.5 MHz (BW = 100 kHz)			-36	dBm
• 87.5 - 118 MHz (BW = 100 kHz)			-54	dBm
• 118 - 174 MHz (BW = 100 kHz)			-36	dBm
• 174 - 230 MHz (BW = 100 kHz)			-54	dBm
• 230 - 470 MHz (BW = 100 kHz)			-36	dBm
• 470 - 862 MHz (BW = 100 kHz)			-54	dBm
• 862 - 1000 MHz (BW = 100 kHz)			-36	dBm
• 1000 - 12750 MHz (BW = 1 MHz)			-30	dBm
Rx Characteristics	Minimum	Typical	Maximum	Unit
Receiver Sensitivity (PER < 30.8%)		-95	-90	dBm
Maximum Input Signal Level (PER < 30.8%)	-10			dBm
PER Report Integrity (-30 dBm input)	50		65.4	%

12.15.2 2 Mbps PHY Condition

Conditions: 25 °C, VDD33 = 3.3V, VDD18 = 1.8V, VIO = 1.8V

Table 65: 2 Mbps PHY Condition

Items	Contents			
Bluetooth Specification (power class)	Version 5.3			
Channel Frequency (spacing)	2402 to 2480 MHz (2 MHz)			
Number of RF Channel	40			
Current Consumption	Minimum	Typical	Maximum	Unit
• Tx mode	VDD18	60		mA
	VDD33	0.2		
• Rx mode	VDD18	20		mA
	VDD33	0.2		
Tx Characteristics	Minimum	Typical	Maximum	Unit
Center Frequency	2402		2480	MHz
Channel Spacing		2		MHz
Number of RF channel		40		
Output Power	0	3	6	dBm
Modulation Characteristics				
• $\Delta f_{1\text{avg}}$	225		275	kHz
• $\Delta f_{2\text{max}}$ (at 99.9%)	185			kHz
• $\Delta f_{2\text{avg}} / \Delta f_{1\text{avg}}$	0.8			
Carrier Frequency Offset and Drift				
• Frequency Offset			150	kHz
• Frequency Drift			50	kHz

Items	Contents			
• Drift Rate			20	kHz
Spurious Emissions				
• 30 - 47 MHz (BW = 100 kHz)			-36	dBm
• 47 - 74 MHz (BW = 100 kHz)			-54	dBm
• 74 - 87.5 MHz (BW = 100 kHz)			-36	dBm
• 87.5 - 118 MHz (BW = 100 kHz)			-54	dBm
• 118 - 174 MHz (BW = 100 kHz)			-36	dBm
• 174 - 230 MHz (BW = 100 kHz)			-54	dBm
• 230 - 470 MHz (BW = 100 kHz)			-36	dBm
• 470 - 862 MHz (BW = 100 kHz)			-54	dBm
• 862 - 1000 MHz (BW = 100 kHz)			-36	dBm
• 1000 - 12750 MHz (BW = 1 MHz)			-30	dBm
Rx Characteristics	Minimum	Typical	Maximum	Unit
Receiver sensitivity (PER < 30.8%)		-95	-90	dBm
Maximum input signal level (PER < 30.8%)	-10			dBm
PER Report Integrity (-30 dBm input)	50		65.4	%

13 Land Patterns

The recommended land pattern is shown in **Figure 17**.

Figure 17: Land Patterns (Unit: mm)

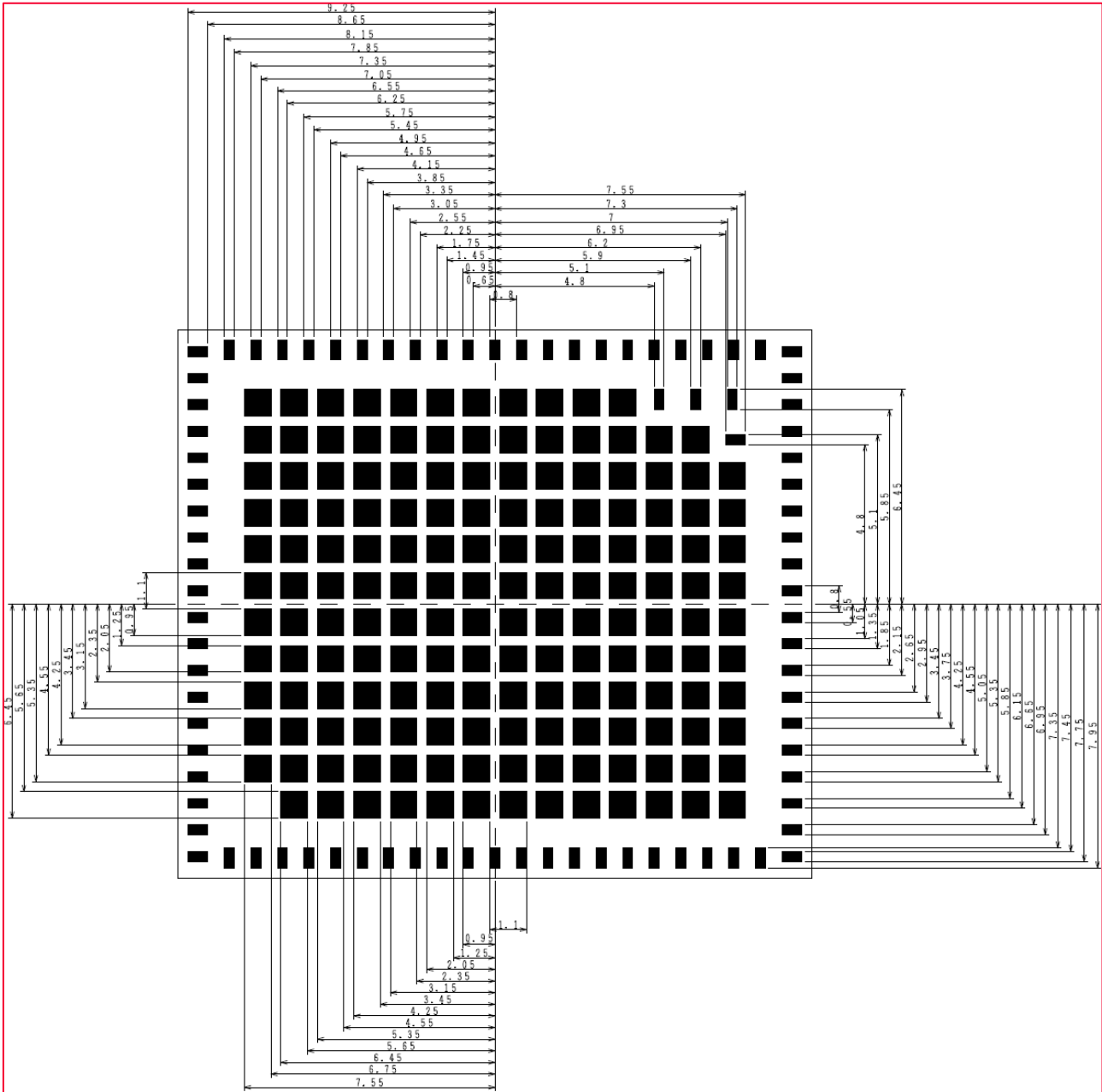

14 Tape and Reel Packing

This section contains the following topics:

- Dimensions of Tape (Plastic tape)
- Dimensions of Reel
- Taping Diagrams
- Leader and tail tape
- Packaging

14.1 Dimensions of Tape (Plastic Tape)

Figure 18 is a graphical representation of the tape dimension (plastic tape)⁷.

Figure 18: Dimensions of Tape (Plastic Tape)

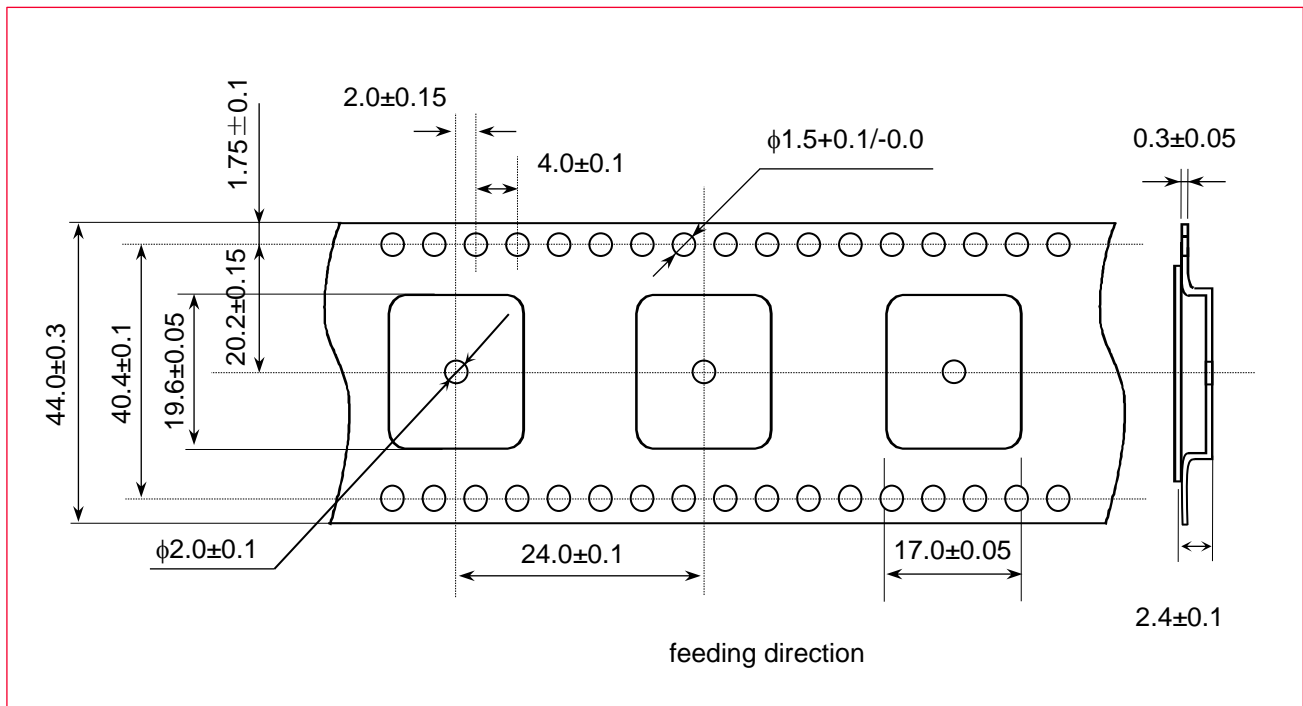

⁷ Cumulative tolerance of maximum 40 +/- 0.15 mm for every 10 pitches.

14.2 Dimensions of Reel

Figure 19 shows the reel dimensions.

Figure 19: Dimensions of Reel (Unit: mm)

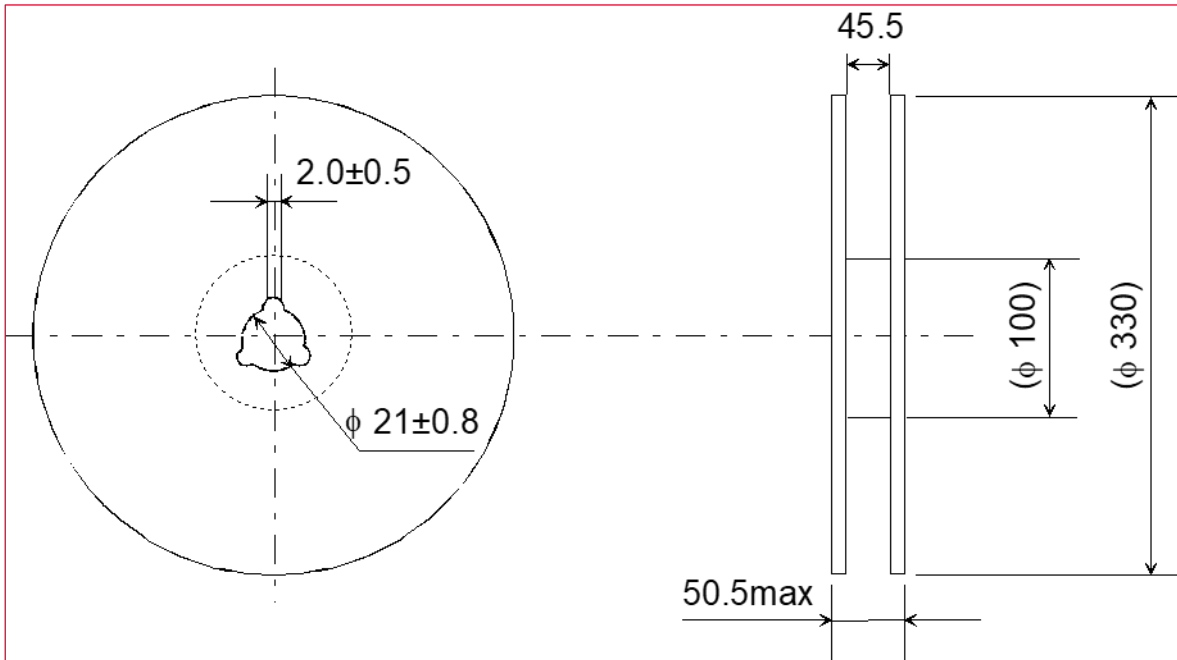

14.3 Taping Diagrams

Figure 20 shows the taping diagrams.

Figure 20: Taping Diagrams

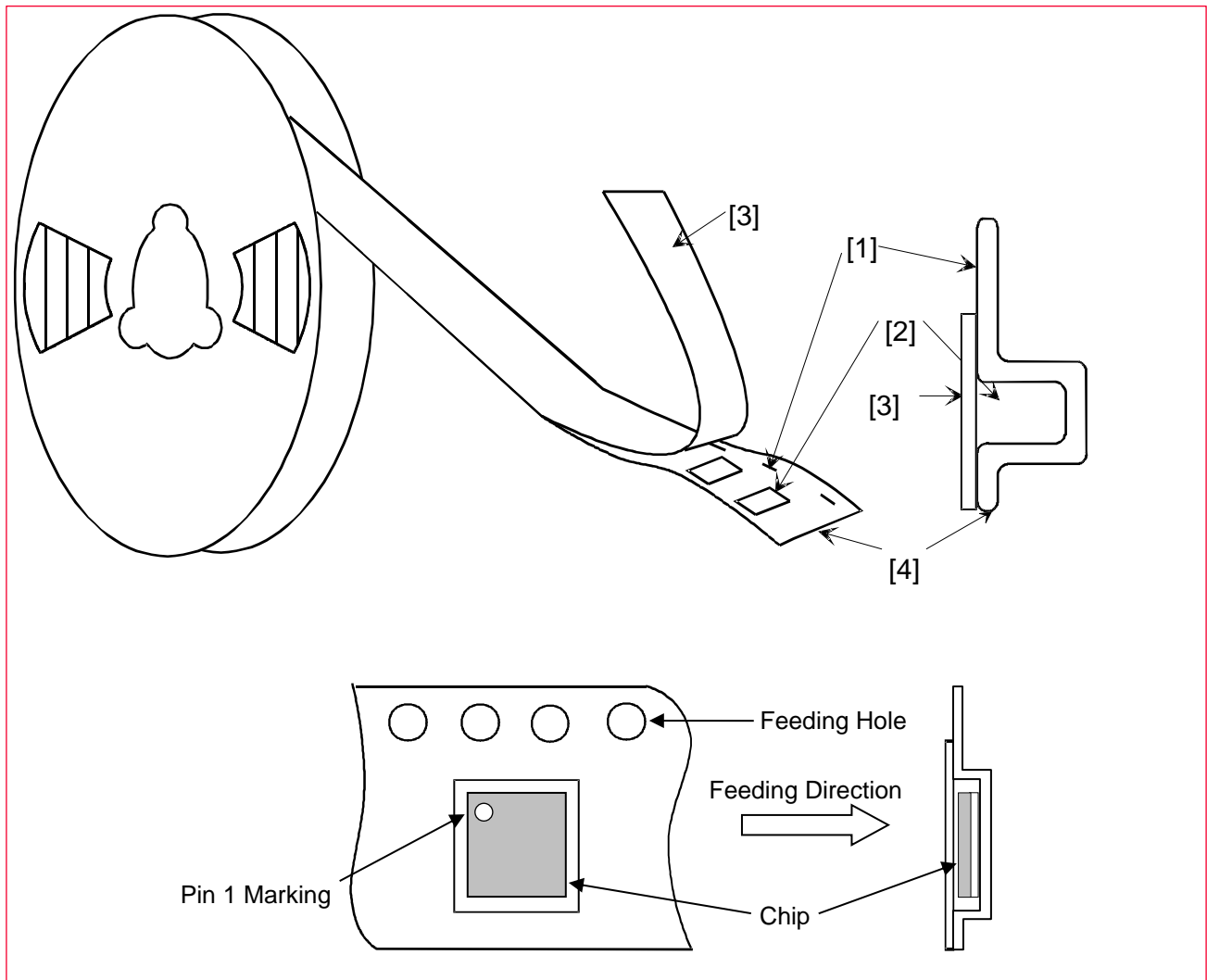

Table 66: Taping Specifications

Mark	Description
1	Feeding Hole. As specified in Dimensions of Tape (Plastic Tape) ☐.
2	Hole for chip. As specified in Dimensions of Tape (Plastic Tape) ☐.
3	Cover tape. 62 μm in thickness.
4	Base tape. As specified in Dimensions of Tape (Plastic Tape) ☐.

14.4 Leader and Tail Tape

The leader and tail tape are shown in **Figure 21**.

Figure 21: Leader and Tail Tape

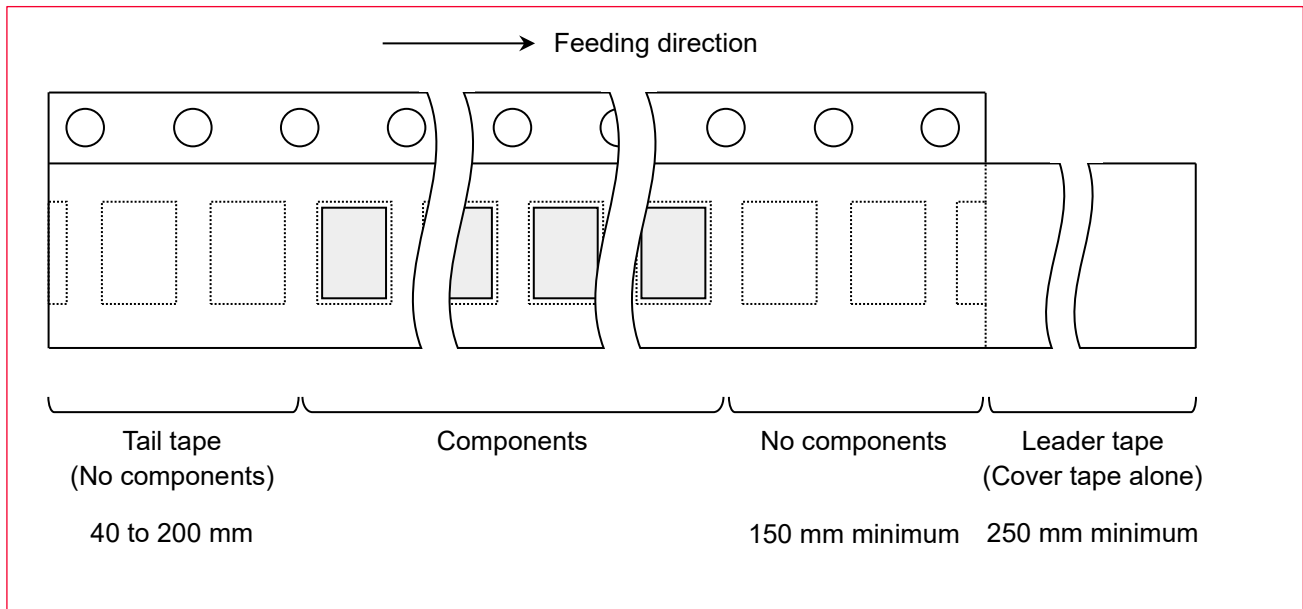

- The tape for chips is wound clockwise, the feeding holes to the right side as the tape is pulled toward the user.
- The cover tape and base tape are not adhered at no components area for 250 mm minimum.
- Tear off strength against pulling of cover tape: 5 N minimum.
- Packaging unit: 500 pcs./ reel
- Material
 - Base tape: Plastic
 - Reel: Plastic
 - Cover tape, cavity tape and reel are made the anti-static processing.
- Peeling off force: 1.1 N maximum. in the direction of peeling as shown in **Figure 22**.

Figure 22: Peeling Force

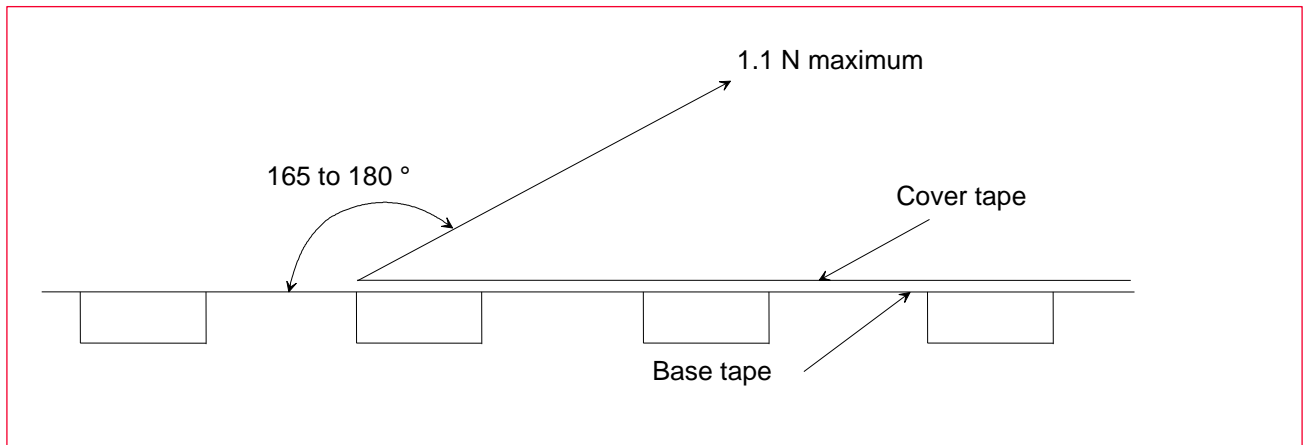

14.5 Packaging (Humidity Proof Packing)

The packaging is shown in **Figure 23**.

Figure 23: Humidity Proof Packing

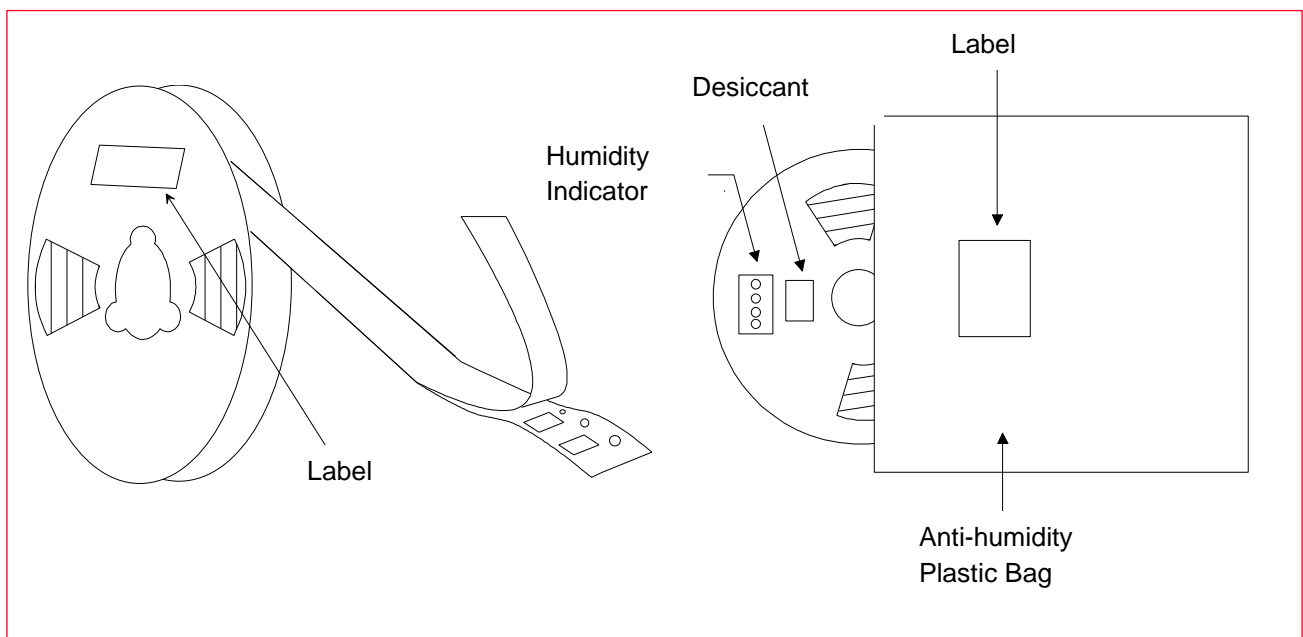

Tape and reel must be sealed with the anti-humidity plastic bag. The bag contains the desiccant and the humidity indicator.

15 Notice

15.1 Storage Conditions

- Please use this product within 6 months after receipt.
- The product shall *be* stored without opening the packing under the ambient temperature from 5 to 35 °C and humidity from 20 ~ 70 %RH.



Packing materials, in particular, may be deformed at the temperature over 40 °C

- The solderability of the product left idle for more than 6 months after receipt needs to be confirmed before it is used.
- The product shall be stored in noncorrosive gas (Cl₂, NH₃, SO₂, NO_x, etc.).
- Any excess mechanical shock including, but not limited to, sticking the packing materials by sharp object, and dropping the product, shall not be applied as that will damage the packing materials.
- This product is applicable to MSL3 (Based on IPC/JEDEC J-STD-020)
 - After the packing is opened, the product shall be stored at <30 °C / <60 %RH and the product shall be used within 168 hours after opening.
 - When the color of the indicator in the packing changed, the product shall be baked before soldering.
- Baking condition: 125 +5/-0 °C, 24 hours, 1 time
- The products shall be baked on the heat-resistant tray because the material (Base Tape, Reel Tape and Cover Tape) is not heat-resistant.

15.2 Handling Conditions

Be careful while handling or transporting products because excessive stress or mechanical shock may break the products.

Handle with care if you suspect that products may have cracks or damages on their terminals. If there is any such damage, the characteristics of products may change. *Do not touch* products with bare hands as that may cause poor solderability and destroy solderability by static electrical charge.

15.3 Standard PCB Design (Land Pattern and Dimensions)

All the ground terminals should be connected to the ground patterns. Furthermore, the ground pattern should be provided between IN and OUT terminals. Please refer to the specifications for the standard land dimensions.

The recommended land pattern and dimensions is as Murata's standard. The characteristics of products may vary depending on the pattern drawing method, grounding method, land dimensions, land forming method of the NC terminals and the PCB material and thickness. Therefore, be sure to verify the characteristics in the actual set.

When using non-standard lands, contact Murata beforehand.

15.4 Notice for Chip Placer

When placing products on the PCB, products may be stressed and broken by uneven forces from a worn-out chucking locating claw or a suction nozzle. To prevent products from damages, be sure to follow the specifications for the maintenance of the chip placer being used. For the positioning of products on the PCB, be aware that mechanical chucking may damage products.

15.5 Soldering Conditions

Soldering must be carried out by the above-mentioned conditions to prevent products damage. Set up the highest temperature of reflow within 260 °C. Contact Murata before use concerning other soldering conditions.

The recommended conditions of soldering are as in **Figure 24**.

Figure 24: Reflow Soldering Standard Conditions (Example)

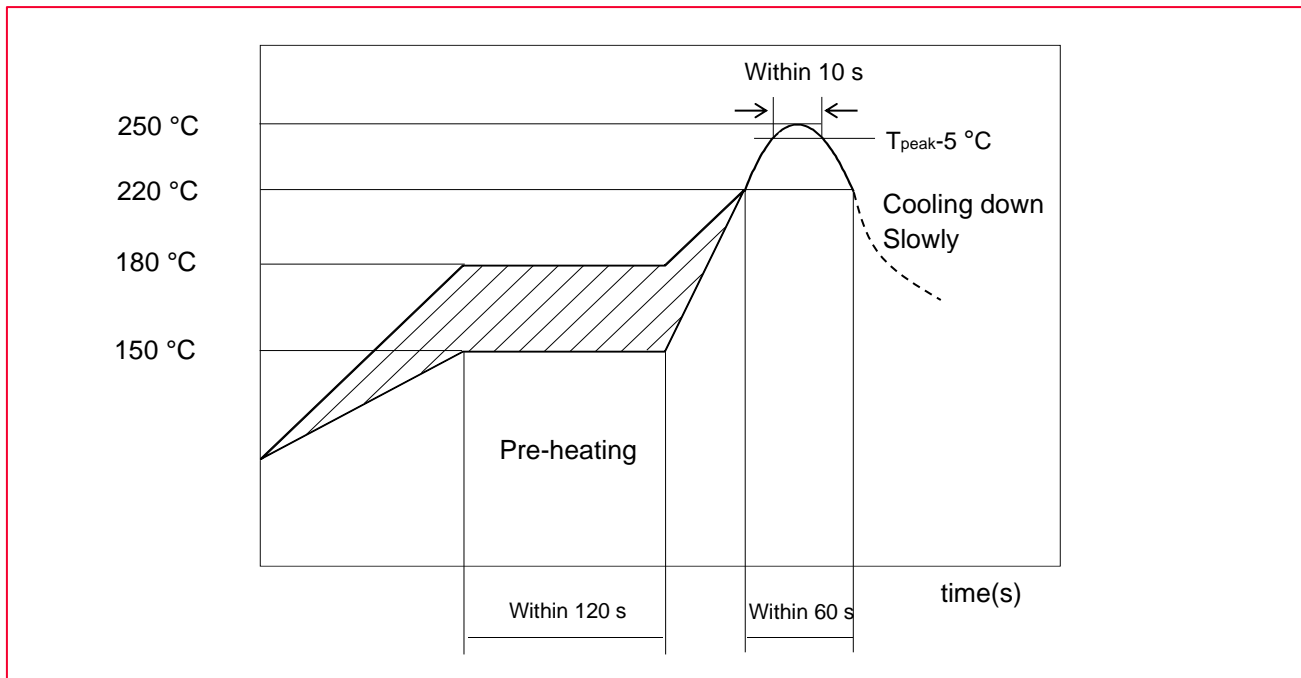

Please use the reflow within 2 times.

Use rosin type flux or weakly active flux with a chlorine content of 0.2 wt. % or less.

15.6 Cleaning

Since this product is moisture sensitive, cleaning is not recommended. If any cleaning process is done the customer is responsible for any issues or failures caused by the cleaning process.

15.7 Operational Environment Conditions

Murata products are designed to work for electronic products under normal environmental conditions (ambient temperature, humidity, and pressure). Therefore, there is no problem in using the products under the above-mentioned conditions. However, using the products under the following circumstances may damage products and cause electricity leakage and abnormal temperature may occur.

- In atmosphere containing corrosive gas (Cl₂, NH₃, SO_x, NO_x etc.).
- In atmosphere containing combustible and volatile gases.
- Dusty place.
- Direct sunlight place.
- Water splashing place.
- Humid place where water condenses.
- Freezing place.



If there is any chance of using the products under the conditions listed above, consult with Murata before actual use.



Do not apply static electricity or excessive voltage while assembling and measuring, as it might be a cause of degradation or destruction to apply static electricity to products.

16 Precondition to Use Our Products



PLEASE READ THIS NOTICE BEFORE USING OUR PRODUCTS.

Please make sure that your product has been evaluated and confirmed from the aspect of the fitness for the specifications of our product when our product is mounted to your product.

All the items and parameters in this product specification/datasheet/catalog have been prescribed on the premise that our product is used for the purpose, under the condition and in the environment specified in this specification. You are requested not to use our product deviating from the condition and the environment specified in this specification.

Please note that the only warranty that we provide regarding the products is its conformance to the specifications provided herein. Accordingly, we shall not be responsible for any defects in products or equipment incorporating such products, which are caused under the conditions other than those specified in this specification.

WE HEREBY DISCLAIM ALL OTHER WARRANTIES REGARDING THE PRODUCTS, EXPRESS OR IMPLIED, INCLUDING WITHOUT LIMITATION ANY WARRANTY OF FITNESS FOR A PARTICULAR PURPOSE, THAT THEY ARE DEFECT-FREE, OR AGAINST INFRINGEMENT OF INTELLECTUAL PROPERTY RIGHTS.

You agree that you will use any and all software or program code (including but not limited to hcd, firmware, nvram, and blob) we may provide or to be embedded into our product (“Software”) provided that you use the Software bundled with our product. YOU AGREE THAT THE SOFTWARE SHALL BE PROVIDED TO YOU “AS IS” BASIS, MURATA MAKES NO REPRESENTATIONS OR WARRANTIES THAT THE SOFTWARE IS ERROR-FREE OR WILL OPERATE WITHOUT INTERRUPTION. AND MORE, MURATA MAKES NO REPRESENTATIONS OR WARRANTIES OF ANY KIND WHETHER EXPRESS OR IMPLIED WITH RESPECT TO THE SOFTWARE. MURATA EXPRESSLY DISCLAIM ANY AND ALL WARRANTIES OR CONDITIONS OF MERCHANTABILITY, FITNESS FOR A PARTICULAR PURPOSE NOR THE WARRANTY OF TITLE OR NON-INFRINGEMENT OF INTELLECTUAL PROPERTY RIGHTS.

You shall indemnify and hold harmless us, our affiliates, and our licensor from and against any and all claims, costs, expenses and liabilities (including attorney’s fees), which arise in connection with the using the Software.

The product shall not be used in any application listed below which requires especially high reliability for the prevention of such defect as may directly cause damage to the third party's life, body or property. You acknowledge and agree that, if you use our products in such applications, we will not be responsible for any failure to meet such requirements. Furthermore, YOU AGREE TO INDEMNIFY AND DEFEND US AND OUR AFFILIATES AGAINST ALL CLAIMS, DAMAGES, COSTS, AND EXPENSES THAT MAY BE INCURRED, INCLUDING WITHOUT LIMITATION, ATTORNEY FEES AND COSTS, DUE TO THE USE OF OUR PRODUCTS AND THE SOFTWARE IN SUCH APPLICATIONS.

- Aircraft equipment.
- Aerospace equipment.
- Undersea equipment.
- Power plant control equipment.
- Medical equipment.
- Traffic signal equipment.

- Burning / explosion control equipment.
- Disaster prevention / crime prevention equipment.
- Transportation equipment (vehicles, trains, ships, elevator, etc.).
- Application of similar complexity and/ or reliability requirements to the applications listed in the above.
- We expressly prohibit you from analyzing, breaking, reverse-engineering, remodeling altering, and reproducing our product. Our product cannot be used for the product which is prohibited from being manufactured, used, and sold by the regulations and laws in the world.

We do not warrant or represent that any license, either express or implied, is granted under any our patent right, copyright, mask work right, or our other intellectual property right relating to any combination, machine, or process in which our products or services are used. Information provided by us regarding third-party products or services does not constitute a license from us to use such products or services or a warranty or endorsement thereof. Use of such information may require a license from a third party under the patents or other intellectual property of the third party, or a license from us under our patents or other intellectual property.

Please do not use our products, our technical information and other data provided by us for the purpose of developing of mass-destruction weapons and the purpose of military use.

Moreover, you must comply with "foreign exchange and foreign trade law", the "U.S. export administration regulations", etc.

Please note that we may discontinue the manufacture of our products, due to reasons such as end of supply of materials and/or components from our suppliers.

By signing on specification sheet or approval sheet, you acknowledge that you are the legal representative for your company and that you understand and accept the validity of the contents herein. When you are not able to return the signed version of specification sheet or approval sheet within 30 days from receiving date of specification sheet or approval sheet, it shall be deemed to be your consent on the content of specification sheet or approval sheet. Customer acknowledges that engineering samples may deviate from specifications and may contain defects due to their development status. We reject any liability or product warranty for engineering samples. In particular we disclaim liability for damages caused by

- The use of the engineering sample other than for evaluation purposes, particularly the installation or integration in the product to be sold by you,
- Deviation or lapse in function of engineering sample,
- Improper use of engineering samples.
- We disclaim any liability for consequential and incidental damages.

If you can't agree with the above contents, please contact sales.

Revision History

Revision Code	Date	Changed Item	Comments
	2020.11.20	First Issue	
A	2021.03.15	5. Dimensions, Marking and Terminal Configurations 6.1 Pin Assignments	<ul style="list-style-type: none"> Changed module size and pin function information.
B	2021.03.29	5. Dimensions, Marking and Terminal Configurations 6.2 Pin Descriptions	<ul style="list-style-type: none"> Changed module height and pin function information.
C	2021.04.05	5. Dimensions, Marking and Terminal Configurations	<ul style="list-style-type: none"> Corrected e5 value from 1.09 to 1.10 mm.
D	2021.04.28	5. Dimensions, Marking and Terminal Configurations 12. Reference Circuit	<ul style="list-style-type: none"> Added Marking information. Added reference circuit.
E	2021.05.05	6.2 Pin Descriptions	<ul style="list-style-type: none"> Corrected pin description
F	2021.06.14	5. Dimensions, Marking and Terminal Configurations	<ul style="list-style-type: none"> Modified Marking information.
G	2021.10.18	1. Scope 2. Key Features 3. Part Number 6. Dimensions, Marking and Terminal Configurations 7.1 Pin Assignments 7.2 Pin Descriptions 7.3 Configuration Pins 7.4 Pin State 7.5 SDIO Pin Descriptions 12. Land patterns	<ul style="list-style-type: none"> Updated Bluetooth version Added a new section Added MP part number Updated terminal size and dimensions. Updated a diagram and Pin 235-238 Updated Pin 235-238 and Pin 68 Added a new section Added a new section Added a new section Added Land pattern figure
H	2022.02.01	4. Block Diagram 9.1 Operating Conditions 7.4 Pin States 13. Reference Circuit	<ul style="list-style-type: none"> Removed sleep clock input Defined IO Current Added PDn Applied change of Pin 235-238 and Pin 68
I	2022.04.01	5.1 Radio Certification 5.2 Bluetooth Qualification 6. Dimensions, Marking and Terminal Configurations 9.1 Operating conditions 9.2 Digital I/O Requirements 9.3 Package thermal conditions 11. Host Interface Specification 12.14 DC/RF Characteristics for Bluetooth 12.15 DC/RF Characteristics for Bluetooth	<ul style="list-style-type: none"> Added certification number Added qualification number Added module structure, Defined T1. Added Junction temperature Added this section Added this section Added this section Added test method Added test method
J	2022.05.09	6. Dimensions, Marking and Terminal Configurations 9.1 Operating conditions 12 DC/RF Characteristics	<ul style="list-style-type: none"> Modified b3 measurement Defined max values of peak current. Defined current consumption and max input level
K	2022.05.31	7.2 Pin Descriptions 7.4 Pin States 14. Reference circuit	<ul style="list-style-type: none"> Updated supply voltage level of IO pins (Power domain) Updated supply voltage level of IO pins (Power domain) Connect Pin 82 to GND. Added comment on GPIO22/23.

Revision Code	Date	Changed Item	Comments
L	2022.08.26	7.2 Pin Descriptions 9.1 Operating Condition 9.3 Package Thermal Conditions 14 Reference Circuit	<ul style="list-style-type: none"> Corrected descriptions of Pin 56, Pin 65 and Pin 76 Added Notes. Corrected value. Corrected connection of Pin 20 and 21.
M	2022.10.03	2. Key Features 3. Part Number 6. Dimensions, Marking and Terminal Configurations 7.4 Pin States 14. Reference Circuit	<ul style="list-style-type: none"> Added more information Added Embedded Artists' M.2 module information. Renamed section. Corrected e9 of dimensions Added comments on termination of open pins. Moved section to HW app note. <p>Updated to new format</p>



Copyright © Murata Manufacturing Co., Ltd. All rights reserved. The information and content in this document are provided “as-is” with no warranties of any kind and are for informational purpose only. Data and information have been carefully checked and are believed to be accurate; however, no liability or responsibility for any errors, omissions, or inaccuracies is assumed.

Wi-Fi® is a registered trademark of Wi-Fi Alliance. The Bluetooth® word mark and logos are registered trademarks owned by Bluetooth SIG, Inc. Other brand and product names are trademarks or registered trademarks of their respective owners.

Specifications are subject to change without notice.