

MMK5223K63J01L16.5TR18

Aliases (F601JF223K063L, MMK5223K63J01L16,5TR18)

Not for New Design • Recommended Replacement Series R60

MMK/F601, Film, Metallized Polyester, General Purpose, 0.022 uF, 10%, 63 VDC, 85°C, Lead Spacing = 5mm

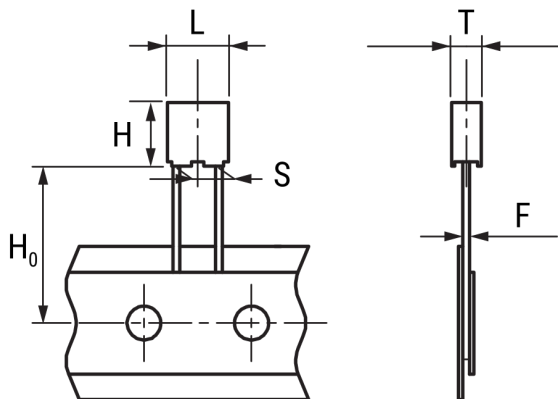

Click [here](#) for the 3D model.

Dimensions

L	7.2mm MAX
H	6.5mm MAX
T	2.5mm MAX
S	5mm +0.6/-0.1mm
H0	16mm NOM
F	0.5mm NOM

Packaging Specifications

Packaging	T&R
Packaging Quantity	2500

General Information

Series	MMK/F601
Dielectric	Metallized Polyester
Style	Radial
Features	DC Multipurpose Applications
RoHS	Yes
Lead	Wire Leads
AEC-Q200	No
Component Weight	0.231 g
Notes	Not for new design - the replacement series is: R60.

Specifications

Capacitance	0.022 uF
Capacitance Tolerance	10%
Voltage AC	40 VAC
Voltage DC	63 VDC, 48.8 VDC (100C)
Temperature Range	-55/+100°C
Rated Temperature	85°C
Dissipation Factor	0.8% 1kHz, 1.2% 10kHz, 2.5% 100kHz
Insulation Resistance	15 GOhms
Max dV/dt	25 V/us
Inductance	6 nH