

## Reset Timer IC for Mobile Equipment

NO.EA-418-180810

### OVERVIEW

The R3201L is a reset timer IC for mobile equipment featuring a shipping mode. This device can detect an external adaptor by the TAIN input signal.

### KEY BENEFITS

- Setting shipping mode provides to improve the battery's consumption at shipping a terminal equipment.
- Despite its extensive functions, achieve 0.35  $\mu$ A low supply current.

### KEY SPECIFICATIONS

- Operating Voltage Range (Max. Rating): 2.2 V to 5.5 V (12.0V)
- Supply Current (at Standby / Shipping mode): Typ.0.35  $\mu$ A
- Operating Temperature Range: -40°C to 85°C
- Reset Request Time: Refer to *Optional Function* for details.
- Reset Request Time Accuracy:  $\pm$ 10%
- Reset Time: Typ.0.4s
- Reset Time Accuracy:  $\pm$ 10%
- Shipping Mode Entry Delay Time (Input pin: OFF): Typ.15 s
- Shipping Mode Entry Command (Input pin: OFF): 5 cycles
- Shipping Mode Exit Delay Time (Input pin: RST0): Typ.2 s
- Output Type (Output pin: SRO, nSRO, DCHGx): Nch. Open Drain and CMOS

### OPTIONAL FUNCTION

Product Name	Package
R3201Lxxx * -E2	QFN014018-10

xxx: Specify a delay time for reset signal.

xxx	Reset Request Time
001	8 s
002	10 s
003	12 s
004	16 s

### TYPICAL APPLICATIONS

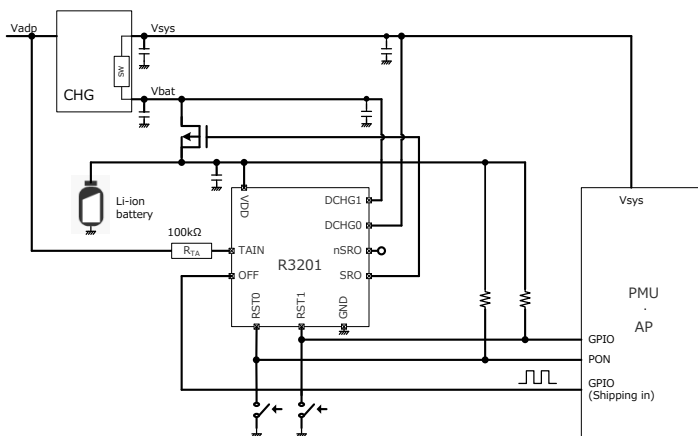

### PACKAGE

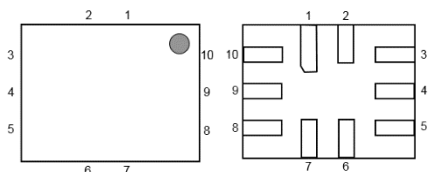

#### QFN014018-10

1.40mm x 1.80 mm,  
t = 0.4 mm (Max.)

### APPLICATIONS

- Battery-powered mobile equipments
- Audio, Home-use electrical medical, and Image processing devices
- Mobile phone, Smartphone, and Wearable devices
- Portable games

---

## R3201L

---

NO.EA-418-180810

## SELECTION GUIDE

Product Name	Package	Quantity per Reel	Pb Free	Halogen Free
R3201Lxxx*-E2	QFN014018-10	5,000 pcs	Yes	Yes

xxx : Reset request time

- 001: 8 s
- 002: 10 s
- 003: 12 s
- 004: 16 s

\* : Output Type

A: Nch Open-drain

---

## BLOCK DIAGRAM

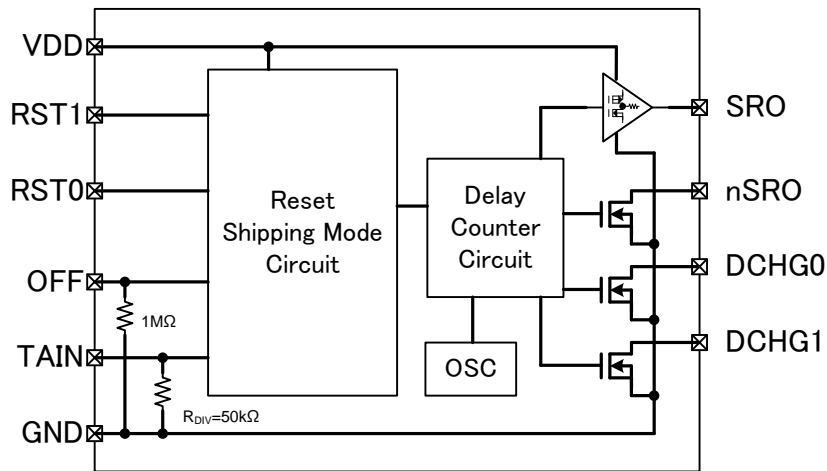

R3201L00xA Block Diagram

## PIN DESCRIPTIONS

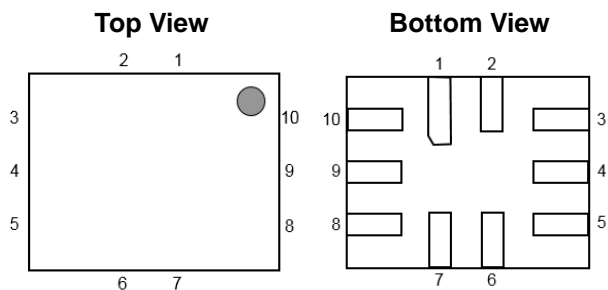

R3201L (QFN014018-10) Pin Configuration

### R3201L Pin Descriptions

Pin No.	Symbol	Description
1	DCHG1	Discharge output pin 1 (Nch. open-drain output) <sup>(1)</sup>
2	TAIN	Adaptor insert detection pin
3	VDD	Power supply input pin
4	RST0	Reset request input pin 0, Active-low
5	RST1	Reset request input pin 1 , Active-low
6	OFF	Shipping mode enter command input pin <sup>(2)</sup>
7	GND	Ground pin
8	SRO	CMOS output pin, Active-high
9	nSRO	Nch open drain output pin, Active-low <sup>(3)</sup>
10	DCHG0	Discharge output pin 0 (Nch. open-drain output) <sup>(1)</sup>

<sup>(1)</sup> The DCHG0 and DCHG1 pins must be connected to GND or left floating if it is not used.

<sup>(2)</sup> The OFF pin must be connected to GND if it is not used (shipping mode is not used).

<sup>(3)</sup> The nSRO pin must be connected to GND or left floating if it is not used.

## R3201L

NO.EA-418-180810

# ABSOLUTE MAXIMUM RATINGS

### Absolute Maximum Ratings

Symbol	Item	Rating	Unit
V <sub>DD</sub>	Supply Voltage	GND -0.3 to 12	V
V <sub>RST0</sub>	RST0 Pin Input Voltage (Input Pin-0)	GND -0.3 to 12	V
V <sub>RST1</sub>	RST1 Pin Input Voltage (Input Pin-1)	GND -0.3 to 12	V
V <sub>SRO</sub>	SRO Pin Output Voltage (Reset Signal Output Pin-0)	GND -0.3 to V <sub>DD</sub> +0.3	V
V <sub>nSRO</sub>	nSRO Pin Output Voltage (Reset Signal Output Pin-1)	GND -0.3 to 6	V
V <sub>TAIN</sub>	TAIN Pin Input Voltage <sup>(1)</sup>	GND -0.3 to 12	V
V <sub>OFF</sub>	OFF Pin Input Voltage	GND -0.3 to 6	V
V <sub>DCHG0</sub>	DCHG0 Pin Output Voltage	GND -0.3 to 12	V
V <sub>DCHG1</sub>	DCHG1 Pin Output Voltage	GND -0.3 to 12	V
P <sub>D</sub>	Power Dissipation <sup>(2)</sup> (QFN014018-10, EDEC STD.51-7 Test Land Pattern)	625	mW
T <sub>j</sub>	Junction Temperature Range	-40 to 125	°C
T <sub>stg</sub>	Storage Temperature Range	-55 to 125	°C

### ABSOLUTE MAXIMUM RATINGS

Electronic and mechanical stress momentarily exceeded absolute maximum ratings may cause the permanent damages and may degrade the life time and safety for both device and system using the device in the field. The functional operation at or over these absolute maximum ratings are not assured.

# RECOMMENDED OPERATING CONDITIONS

### Recommended Operating Conditions

Symbol	Item	Rating	Unit
V <sub>DD</sub>	Supply Voltage	2.2 to 5.5	V
T <sub>a</sub>	Operating Temperature Range	-40 to 85	°C

### RECOMMENDED OPERATING CONDITIONS

All of electronic equipment should be designed that the mounted semiconductor devices operate within the recommended operating conditions. The semiconductor devices cannot operate normally over the recommended operating conditions, even if when they are used over such conditions by momentary electronic noise or surge. And the semiconductor devices may receive serious damage when they continue to operate over the recommended operating conditions. The device electrical characteristics up to 125°C are evaluated at preproduction.

<sup>(1)</sup> Refer to *TAIN Test Circuit* information.

<sup>(2)</sup> Refer to *POWER DISSIPATION* for detailed information.

## ELECTRICAL CHARACTERISTICS

The specifications surrounded by   are guaranteed by design engineering at  $-40^{\circ}\text{C} \leq T_a \leq 85^{\circ}\text{C}$ .

### R3201L Electrical Characteristics

(Ta = 25°C)

Symbol	Item	Conditions	Min.	Typ.	Max.	Unit
I <sub>SS1</sub>	Supply current 1 <sup>(1)</sup>	V <sub>DD</sub> = 4.0 V (at standby)		0.35	<span style="border: 1px solid black; padding: 0 2px;">1.0</span>	μA
I <sub>SS2</sub>	Supply current 2 <sup>(2)</sup>	V <sub>DD</sub> = 4.0V (at active reset counter & reset signal output)		3	<span style="border: 1px solid black; padding: 0 2px;">10</span>	μA
I <sub>SS3</sub>	Supply current 3 <sup>(3)</sup>	V <sub>DD</sub> = 4.0V (at active after reset signal output)		0.4	<span style="border: 1px solid black; padding: 0 2px;">1.7</span>	μA
V <sub>IL1</sub>	RST0/RST1 input voltage, low				<span style="border: 1px solid black; padding: 0 2px;">0.3</span>	V
V <sub>IH1</sub>	RST0/RST1 input voltage, high		<span style="border: 1px solid black; padding: 0 2px;">1.15</span>		<span style="border: 1px solid black; padding: 0 2px;">V<sub>DD</sub></span>	V
V <sub>IL2</sub>	OFF input voltage, low				<span style="border: 1px solid black; padding: 0 2px;">0.4</span>	V
V <sub>IH2</sub>	OFF input voltage, high		<span style="border: 1px solid black; padding: 0 2px;">1.0</span>		<span style="border: 1px solid black; padding: 0 2px;">5.5</span>	V
I <sub>IIL</sub>	OFF (pull-down pin) input leakage current, low	V <sub>I</sub> = 0 V	<span style="border: 1px solid black; padding: 0 2px;">-0.1</span>		<span style="border: 1px solid black; padding: 0 2px;">0.1</span>	μA
I <sub>IHH</sub>	OFF (pull-down pin) input leakage current, high	V <sub>DD</sub> = 5.5 V , V <sub>I</sub> = V <sub>DD</sub>		5.5		μA
T <sub>DEB</sub>	Debounce time of RST0/RST1			10		msec

### ■ RESET Operation

T <sub>R</sub>	Reset request time	R3201L001	<span style="border: 1px solid black; padding: 0 2px;">7.2</span>	8	<span style="border: 1px solid black; padding: 0 2px;">8.8</span>	sec
		R3201L002	<span style="border: 1px solid black; padding: 0 2px;">9</span>	10	<span style="border: 1px solid black; padding: 0 2px;">11</span>	
		R3201L003	<span style="border: 1px solid black; padding: 0 2px;">10.8</span>	12	<span style="border: 1px solid black; padding: 0 2px;">13.2</span>	
		R3201L004	<span style="border: 1px solid black; padding: 0 2px;">14.4</span>	16	<span style="border: 1px solid black; padding: 0 2px;">17.6</span>	
T <sub>D</sub>	Reset time		<span style="border: 1px solid black; padding: 0 2px;">0.36</span>	0.4	<span style="border: 1px solid black; padding: 0 2px;">0.44</span>	sec
T <sub>O</sub>	SRO output pin slew rate time (rising and falling time)	V <sub>DD</sub> = 4 V, Q <sub>g</sub> = 20nC	<span style="border: 1px solid black; padding: 0 2px;">1</span>	2	<span style="border: 1px solid black; padding: 0 2px;">3</span>	msec
T <sub>DD</sub>	Discharge active of DCHG0/1 delay time		<span style="border: 1px solid black; padding: 0 2px;">3</span>	4	<span style="border: 1px solid black; padding: 0 2px;">5</span>	msec
I <sub>D</sub>	Discharge current of DCHG0/1	V <sub>DD</sub> = V <sub>DCHG0,1</sub> = 4 V		50		mA
V <sub>OL</sub>	nSRO output voltage, low	I <sub>OL</sub> = 2 mA			<span style="border: 1px solid black; padding: 0 2px;">0.3</span>	V
I <sub>LEAKO</sub>	nSRO output leakage current	V <sub>DD</sub> = 5.5 V			<span style="border: 1px solid black; padding: 0 2px;">0.1</span>	μA

<sup>(1)</sup> Supply current when the device is active and waiting for the reset input.

<sup>(2)</sup> Supply current when the RST0 and RST1 input pins are low and the timer operation is running.

<sup>(3)</sup> Supply current after the automatic cancellation of reset signal following the completion of timer operation and the output of rest signal.

---

**R3201L**

---

NO.EA-418-180810

The specifications surrounded by   are guaranteed by design engineering at  $-40^{\circ}\text{C} \leq T_a \leq 85^{\circ}\text{C}$ .**R3201L Electrical Characteristics (Continued)**

(Ta = 25°C)

Symbol	Item	Conditions	Min.	Typ.	Max.	Unit
<b>■ TAIN Detect Operation</b>						
V <sub>TA_DET</sub>	Input detection voltage for R <sub>TA</sub>	R <sub>TA</sub> = 100kΩ, R <sub>DIV</sub> = 50kΩ	<span style="border: 1px solid black; padding: 0 2px;">2</span>		<span style="border: 1px solid black; padding: 0 2px;">4.4</span>	V
V <sub>TA_RELEASE</sub>	Input release voltage for R <sub>TA</sub>	R <sub>TA</sub> = 100kΩ, R <sub>DIV</sub> = 50kΩ	<span style="border: 1px solid black; padding: 0 2px;">1</span>		<span style="border: 1px solid black; padding: 0 2px;">3.4</span>	V
V <sub>TA_HYS</sub>	Input hysteresis voltage for R <sub>TA</sub>	R <sub>TA</sub> = 100kΩ, R <sub>DIV</sub> = 50kΩ	<span style="border: 1px solid black; padding: 0 2px;">0.8</span>			V
T <sub>TA</sub>	TAIN input detection delay Time		<span style="border: 1px solid black; padding: 0 2px;">20</span>	50	<span style="border: 1px solid black; padding: 0 2px;">100</span>	ms
<b>■ Shipping Mode Operation</b>						
T <sub>S</sub>	Shipping mode entry delay time		<span style="border: 1px solid black; padding: 0 2px;">12</span>	15	<span style="border: 1px solid black; padding: 0 2px;">18</span>	sec
N <sub>OFF</sub>	Shipping mode entry command			5		Cycle
T <sub>1</sub>	HIGH and LOW hold time of OFF-pin input pulse		<span style="border: 1px solid black; padding: 0 2px;">1</span>	2		msec
T <sub>2</sub>	Entry limited time at shipping mode	Total 5 pulses Time of OFF-pin input pulse			<span style="border: 1px solid black; padding: 0 2px;">100</span>	msec
T <sub>3</sub>	Shipping mode exit delay time		<span style="border: 1px solid black; padding: 0 2px;">1.6</span>	2	<span style="border: 1px solid black; padding: 0 2px;">2.4</span>	sec
I <sub>OFF</sub>	Supply current at shipping mode	V <sub>DD</sub> = 4.0 V		0.35	<span style="border: 1px solid black; padding: 0 2px;">1.0</span>	μA

All test items listed under *ELECTRICAL CHARACTERISTICS* are done under the pulse load condition (T<sub>j</sub> ≈ T<sub>a</sub> = 25°C) except Supply Current 2.

## THEORY OF OPERATION

### Reset Operation-1

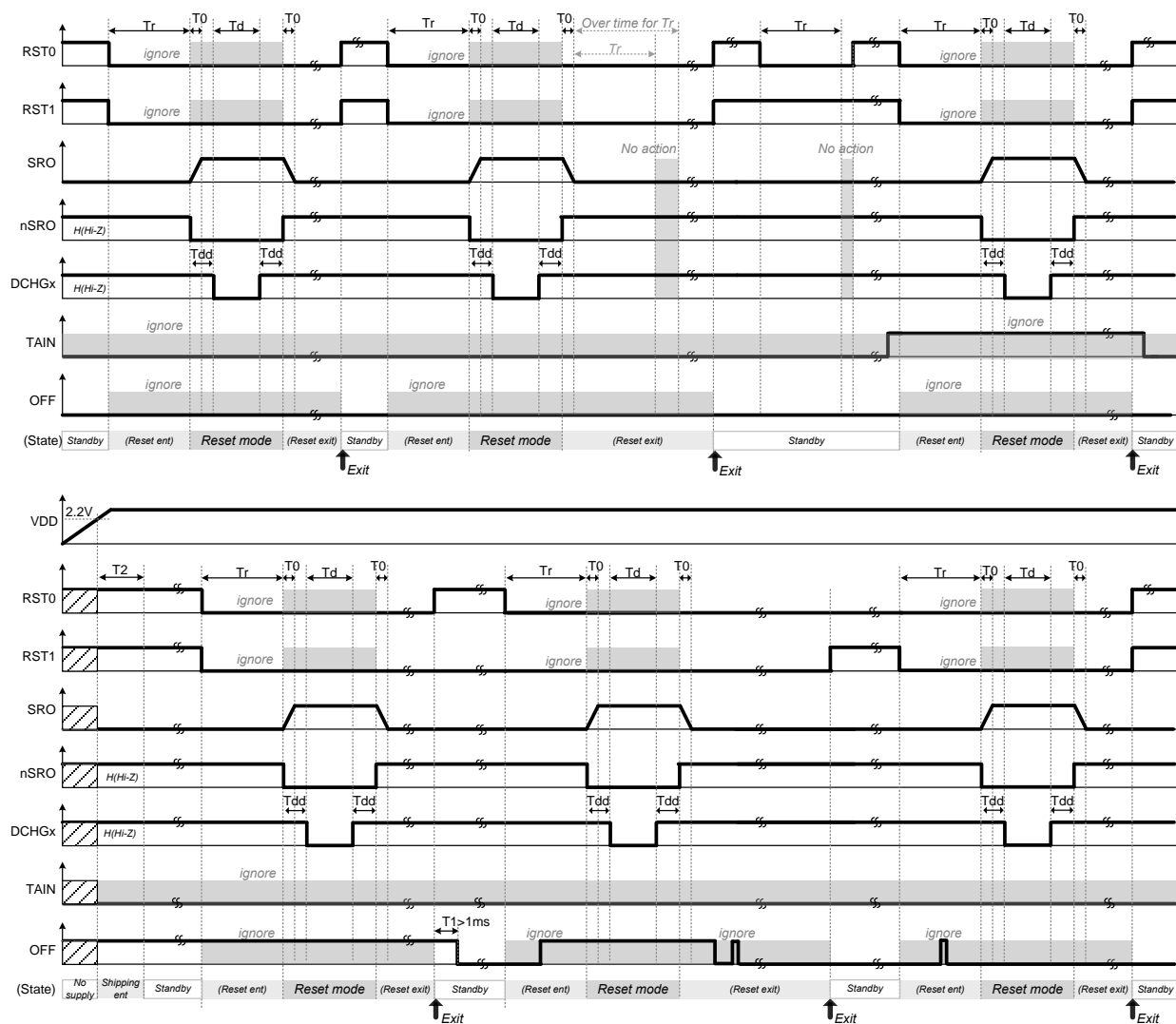

Reset Timing Chart 1

1. When both active-low input pins (RST0 and RST1) become Low level, Reset operation starts.
2. After the period of  $T_r$  time, R3201L enters into Reset mode.
3. If RST0 or RST1 becomes High level before Reset mode, reset operation will be cancelled.
4. Once the R3201L finishes the Reset mode, it keep same state (Reset exit state) as long as both RST0 and RST1 remain Low level.
5. In order to move to Standby, High level input is needed to RST0 or RST1.
6. The debounce time of RST0 and RST1 (L→H, H→L) is 10 [msec].

# R3201L

NO.EA-418-180810

## Reset Operation-2

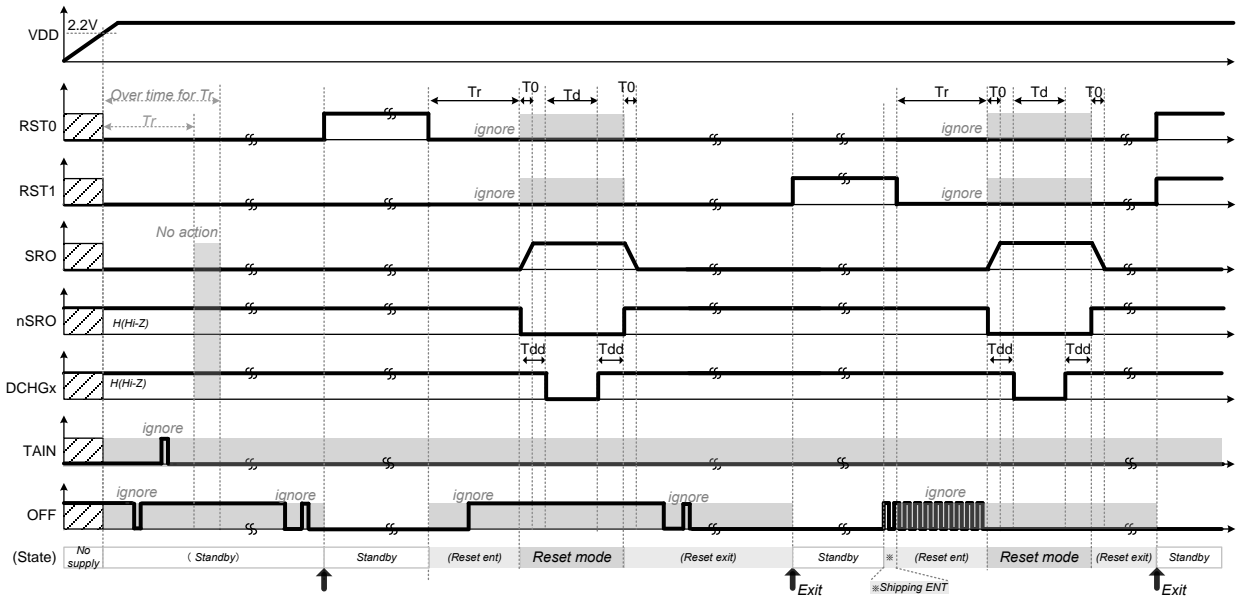

Reset Timing Chart 2

## SRO/ nSRO/ DCHGx Operation

SRO slew rate time, nSRO and Discharge ON/OFF timing (DCHGx) follow;

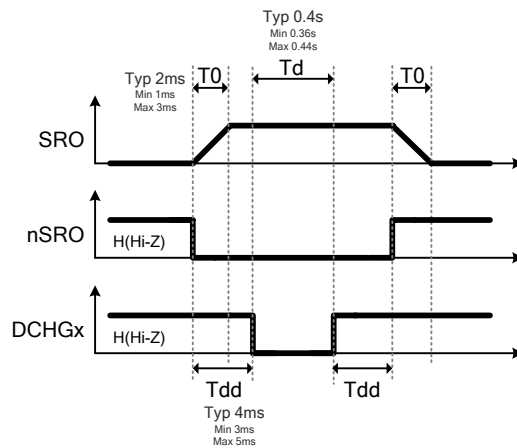

$Q_g = 20 \text{ nC}$  (external P-MOSFET @SRO pin control)

$$T_0 [\text{s}] = ( Q_g / V_{DD} ) \times ( 132\text{k}\Omega ) \times 3 \quad \text{※}132\text{k}\Omega \cdots \text{IC internal resistance}$$

### SRO/ nSRO/ DCHGx Timing





# R3201L

NO.EA-418-180810

## State Diagram

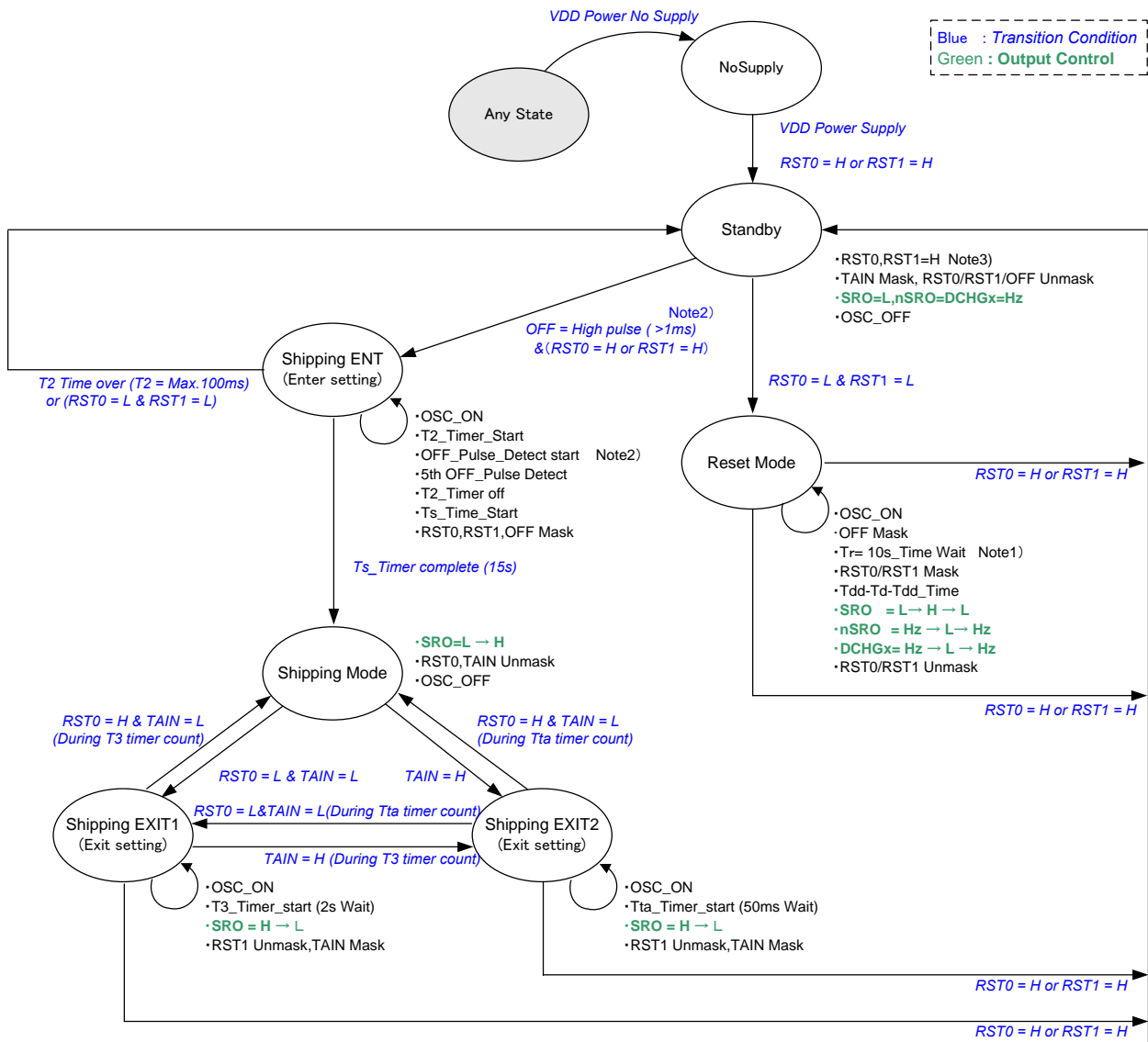

Note1) 8s, 10s, 12s, 16s code selectable option

Note2) OFF input pin supports debounce function. The initial value in the debounce circuit is "OFF=L" at Power ON.

Input pulse width of OFF pin must be at least T1 time (min.1ms). If the pulse width is shorter than T1 time, R3201x may not be able to recognize pulse input. When the 5th Pulse input of OFF-pin is not inputted by T2 time, R3201x is not moved to the shipping mode by lack of the shipping mode setting request.

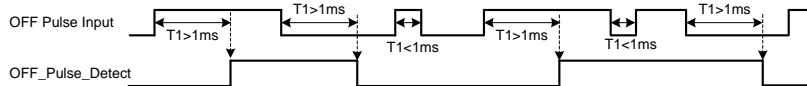

Note3) RST0/RST1 input pins support debounce function. Debounce circuit for RST0/RST1 is reset on transition to Standby state (except from Shipping ENT state). Initial values of debounce circuit are "H".

# APPLICATION INFORMATION

## Typical Application Circuit

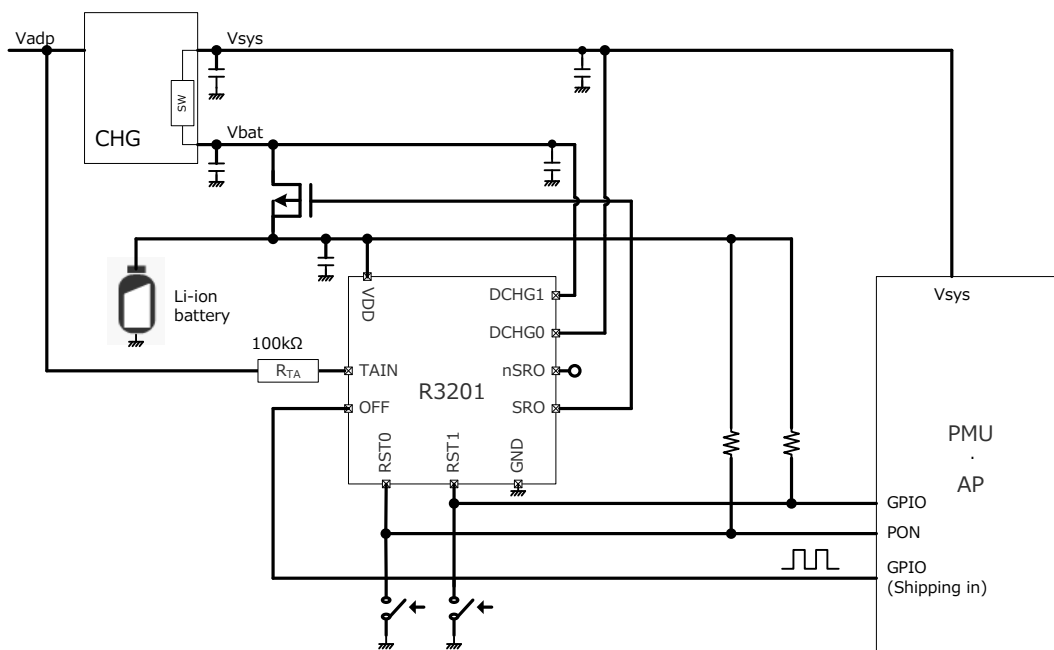

R3201L Typical Application Circuit

# R3201L

NO.EA-418-180810

## TYPICAL CHARACTERISTICS

Note: Typical Characteristics are intended to be used as reference data, they are not guaranteed.

1) Supply Current 1  
R3201Lxxx

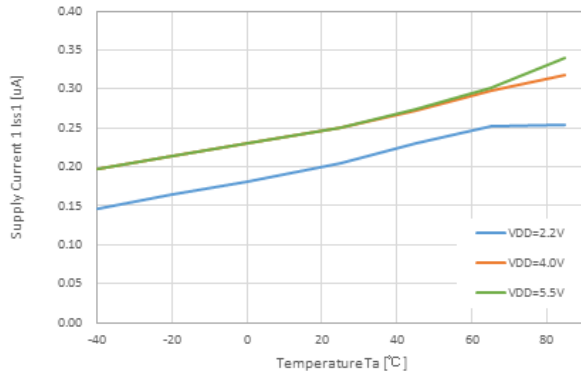

2) Supply Current 2  
R3201Lxxx

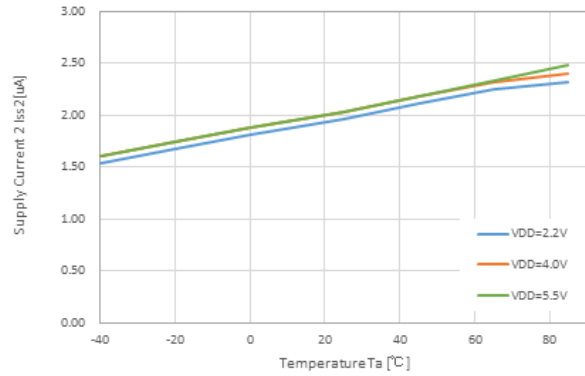

3) Supply Current 3  
R3201Lxxx

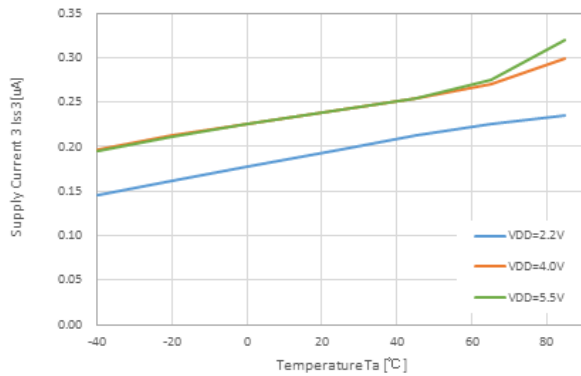

4) Supply Current at Shipping Mode  
R3201Lxxx

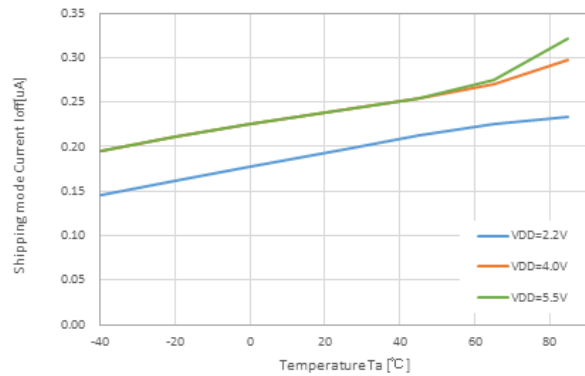

5)  $R_{TA}$  Input Detection Voltage  
R3201Lxxx

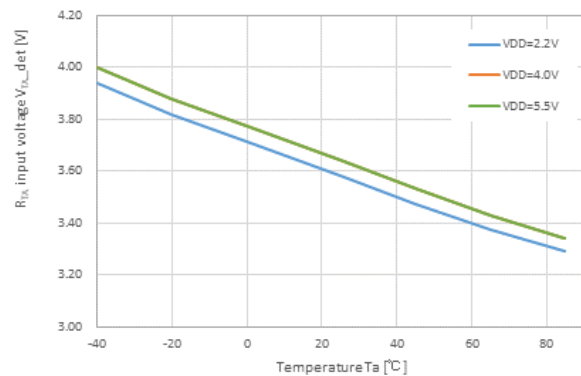

6)  $R_{TA}$  Input Release Voltage  
R3201Lxxx

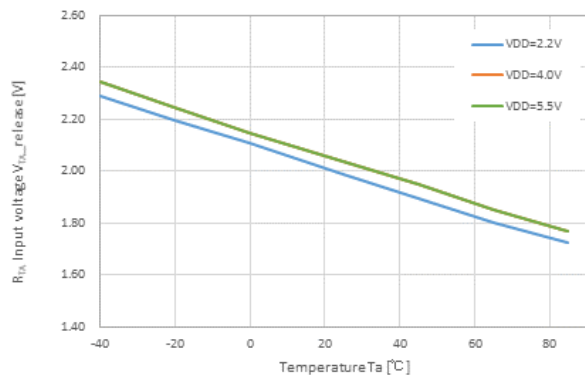

7)  $R_{TA}$  Input Hysteresis Voltage  
R3201Lxxx

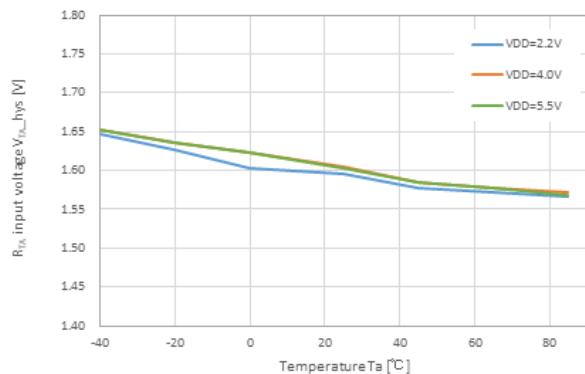

8) Reset Request Time  
R3201Lxx1(8s)

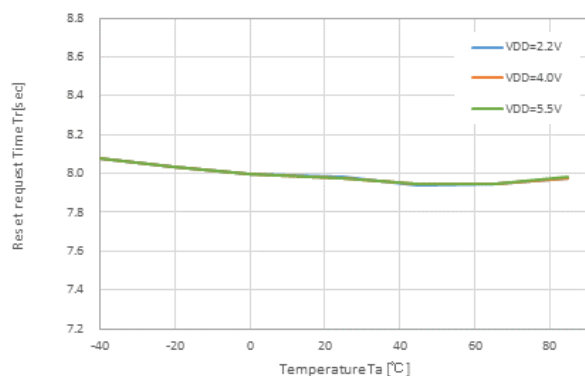

R3201Lxx2(10s)

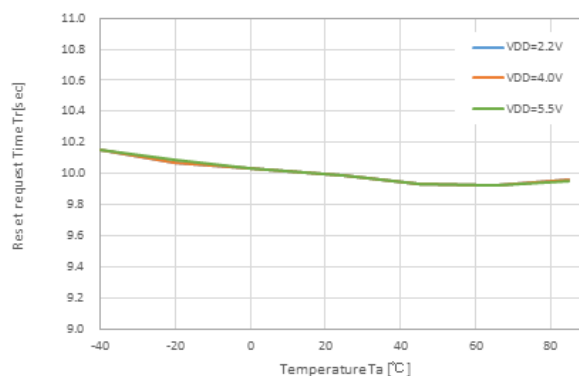

R3201Lxx3(12s)

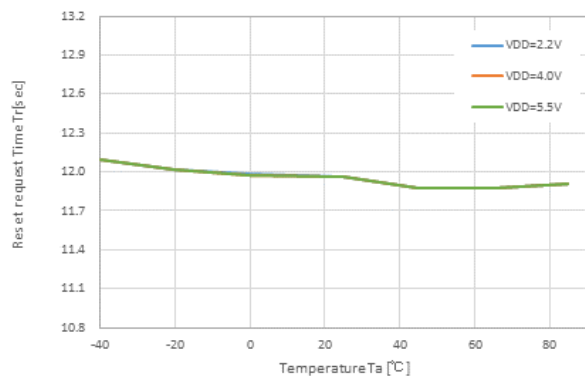

R3201Lxx4(16s)

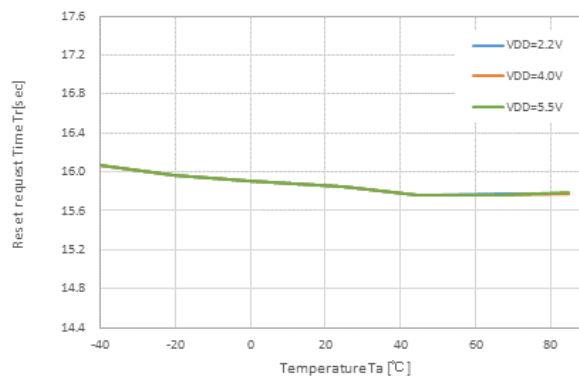

The power dissipation of the package is dependent on PCB material, layout, and environmental conditions. The following measurement conditions are based on JEDEC STD. 51-7.

**Measurement Conditions**

Item	Measurement Conditions
Environment	Mounting on Board (Wind Velocity = 0 m/s)
Board Material	Glass Cloth Epoxy Plastic (Four-Layer Board)
Board Dimensions	76.2 mm × 114.3 mm × 0.8 mm
Copper Ratio	Outer Layer (First Layer): Less than 95% of 50 mm Square Inner Layers (Second and Third Layers): Approx. 100% of 50 mm Square Outer Layer (Fourth Layer): Approx. 100% of 50 mm Square
Through-holes	φ 0.3 mm × 36 pcs

**Measurement Result**

(Ta = 25°C, Tjmax = 125°C)

Item	Measurement Result
Power Dissipation	625 mW
Thermal Resistance (θja)	θja = 160°C/W
Thermal Characterization Parameter (ψjt)	ψjt = 76°C/W

θja: Junction-to-Ambient Thermal Resistance

ψjt: Junction-to-Top Thermal Characterization Parameter

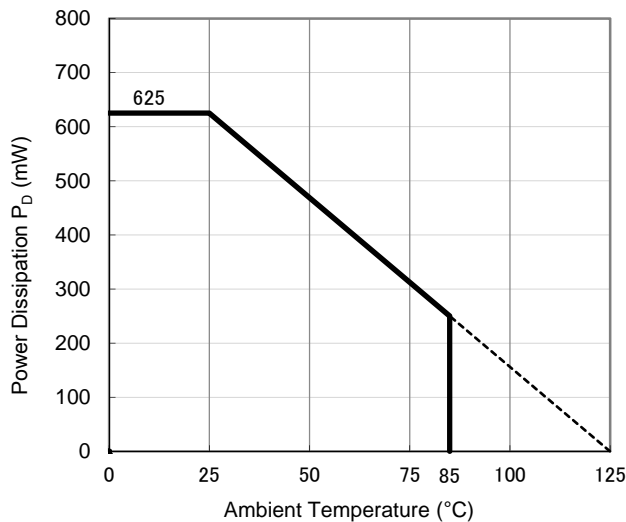

**Power Dissipation vs. Ambient Temperature**

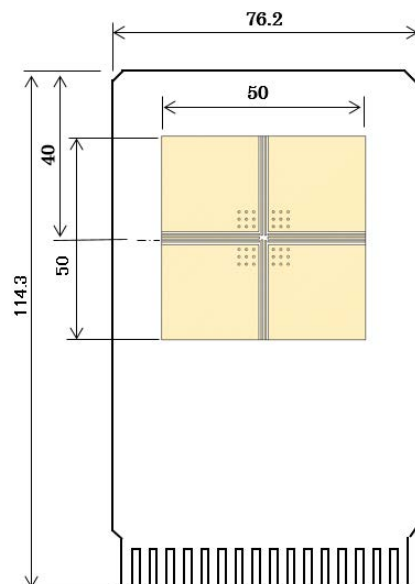

**Measurement Board Pattern**

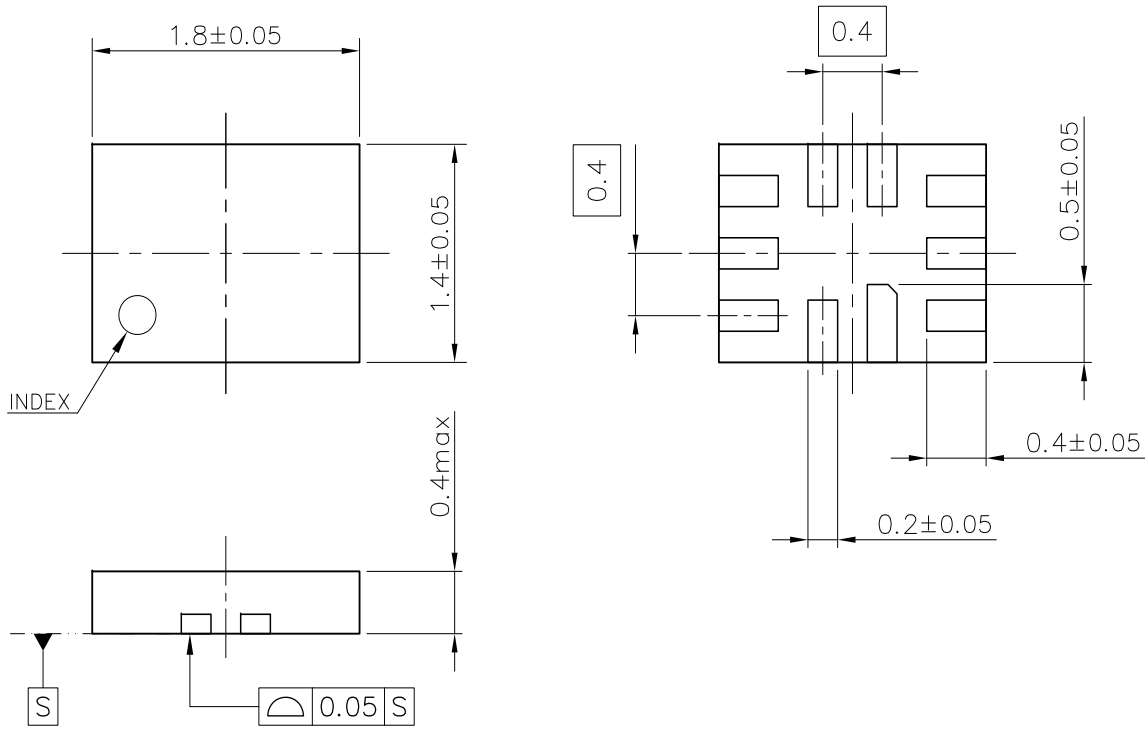

**QFN014018-10 Package Dimensions (Unit: mm)**

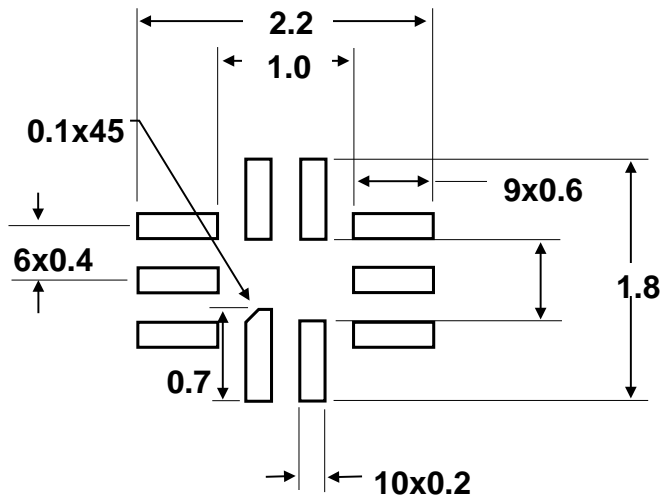

**QFN014018-10 Recommended Land Pattern (Unit: mm)**



1. The products and the product specifications described in this document are subject to change or discontinuation of production without notice for reasons such as improvement. Therefore, before deciding to use the products, please refer to our sales representatives for the latest information thereon.
2. The materials in this document may not be copied or otherwise reproduced in whole or in part without prior written consent of our company.
3. Please be sure to take any necessary formalities under relevant laws or regulations before exporting or otherwise taking out of your country the products or the technical information described herein.
4. The technical information described in this document shows typical characteristics of and example application circuits for the products. The release of such information is not to be construed as a warranty of or a grant of license under our company's or any third party's intellectual property rights or any other rights.
5. The products listed in this document are intended and designed for use as general electronic components in standard applications (office equipment, telecommunication equipment, measuring instruments, consumer electronic products, amusement equipment etc.). Those customers intending to use a product in an application requiring extreme quality and reliability, for example, in a highly specific application where the failure or misoperation of the product could result in human injury or death (aircraft, spacevehicle, nuclear reactor control system, traffic control system, automotive and transportation equipment, combustion equipment, safety devices, life support system etc.) should first contact us.
6. We are making our continuous effort to improve the quality and reliability of our products, but semiconductor products are likely to fail with certain probability. In order to prevent any injury to persons or damages to property resulting from such failure, customers should be careful enough to incorporate safety measures in their design, such as redundancy feature, fire containment feature and fail-safe feature. We do not assume any liability or responsibility for any loss or damage arising from misuse or inappropriate use of the products.
7. Anti-radiation design is not implemented in the products described in this document.
8. The X-ray exposure can influence functions and characteristics of the products. Confirm the product functions and characteristics in the evaluation stage.
9. WLCSP products should be used in light shielded environments. The light exposure can influence functions and characteristics of the products under operation or storage.
10. There can be variation in the marking when different AOI (Automated Optical Inspection) equipment is used. In the case of recognizing the marking characteristic with AOI, please contact our sales or our distributor before attempting to use AOI.
11. Please contact our sales representatives should you have any questions or comments concerning the products or the technical information.



**Nisshinbo Micro Devices Inc.**

**Official website**

<https://www.nisshinbo-microdevices.co.jp/en/>

**Purchase information**

<https://www.nisshinbo-microdevices.co.jp/en/buy/>

