

THIS DOCUMENT IS THE PROPERTY OF
KEYSTONE ELECTRONICS CORP. AND
SHALL NOT BE REPRODUCED, DISTRIBUTED
OR USED AS A BASIS FOR MANUFACTURE
WITHOUT PRIOR WRITTEN PERMISSION
FROM KEYSTONE ELECTRONICS CORP.

ACTUAL SIZE

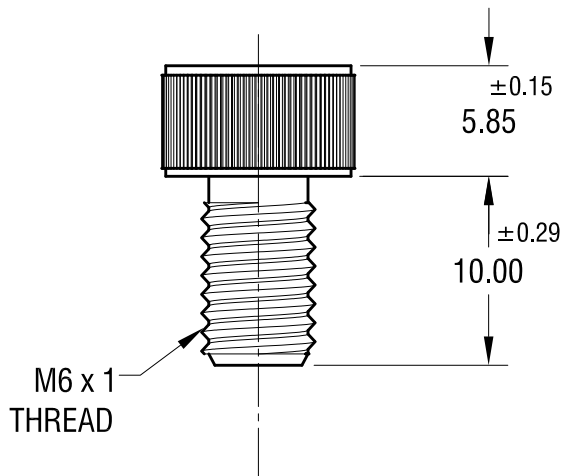
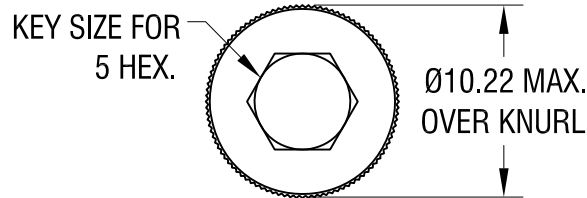

NOTE:

1. ALL DIMENSIONS ARE IN MILLIMETERS

KEYSTONE ELECTRONICS CORP.			
www.keyelco.com • NEW HYDE PARK, NY 11040 • Tel (516) 328-7500			
PART NAME		SOCKET HEAD SCREW	
MATERIAL		TITANIUM, GRADE 2	
FINISH		DRN BY	DATE
NONE		NT	10.31.19
		APP'D	SCALE
		RH	2.5X
TOLERANCES	INCH	[MM]	CODE
DECIMAL	±	[± 0.13]	C
ANGULAR	± 1°		
UNLESS OTHERWISE SPECIFIED			DWG NO.
			25061

DATE	DESCRIPTION	REV.