

74-FHX, Fuse Holder for MAX Equivalent Auto Fuses

Specifications:

- Suitable for MAX Equivalent Blade Type Automotive Fuses
- Rating: 60A Max, 12/24/32VDC
- Isolation Resistance: 500V DC, 100MΩ Min
- Dielectric Strength: 1000V AC, 1 minute
- Body Material: Nylon 66, Black (Max. Temperature +85°C)
- Fuse Ratings / Wire Gauge:
 - 20A (Yellow) / 12 AWG
 - 30A (Green) / 10 AWG
 - 40A (Orange) / 8 AWG
 - 50A (Red) / 8 AWG
 - 60A (Blue) / 6 AWG

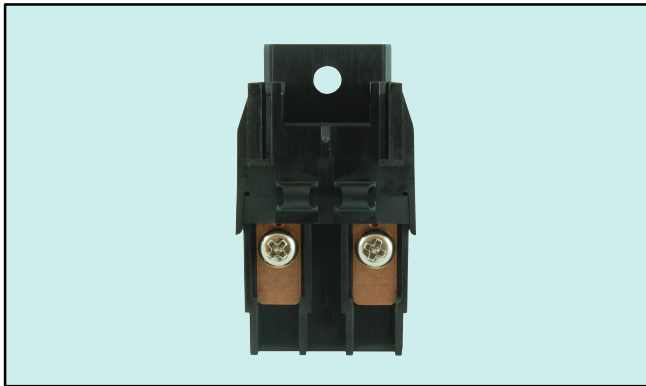

FA-13

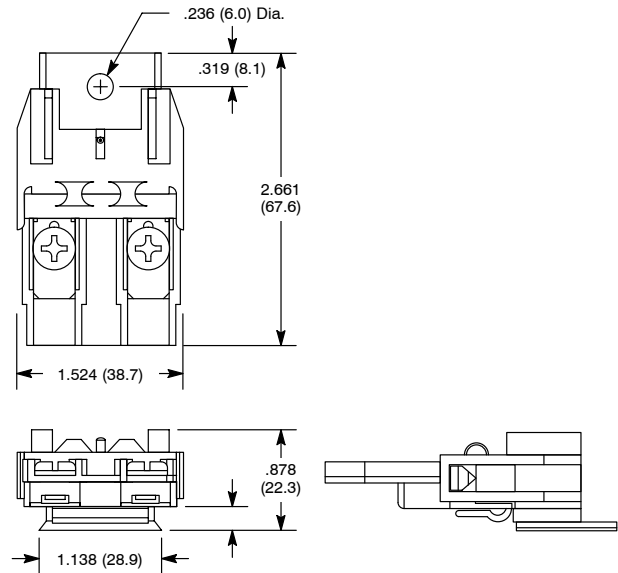

74-AFT-1, Automotive Fuse Circuit Tap for Standard ATO/ATM Blade Fuses

Specifications:

- Thin In-Line Fuse Holder Designed to Accommodate Two Fuses in One Slot
- For use with ATO/ATP/ATC type Fuses.
- Max. Installation Rating: 15 Amps.
- Butt Splice Connectors Pull-Out Force: 15kg. Min.
- Cable Wire: #16AWG, 5" (127mm) Red Wire (UL1015)
- RoHS Compliant. Product not UL Listed.

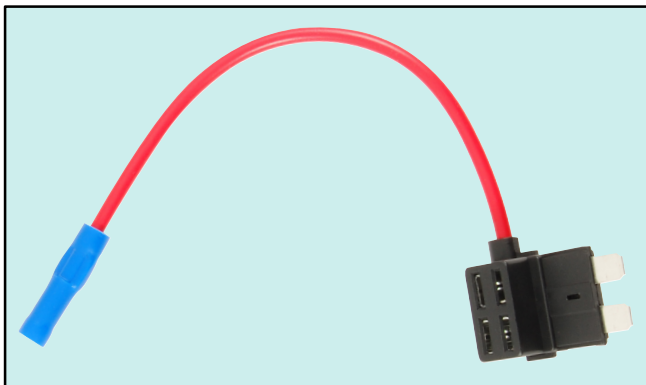

FA-15

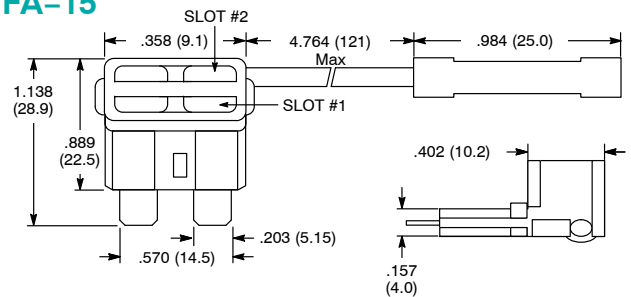

Description:

This device has slots for two fuses. SLOT #1 is for the fuse that was originally inside the panel. SLOT #2 is for the lead that is tapping off and is limited to 10 Amps max.

74-AFT-2, Automotive Fuse Circuit Tap for ATC Mini Blade Fuses

Specifications:

- Thin In-Line Fuse Holder Designed to Accommodate Two Fuses in One Slot
- For use with MINI/ATM/ASP type Fuses.
- Max. Installation Rating: 15 Amps.
- Butt Splice Connectors Pull-Out Force: 15kg. Min.
- Cable Wire: #16AWG, 5" (127mm) Red Wire (UL1015)
- RoHS Compliant. Product not UL Listed.

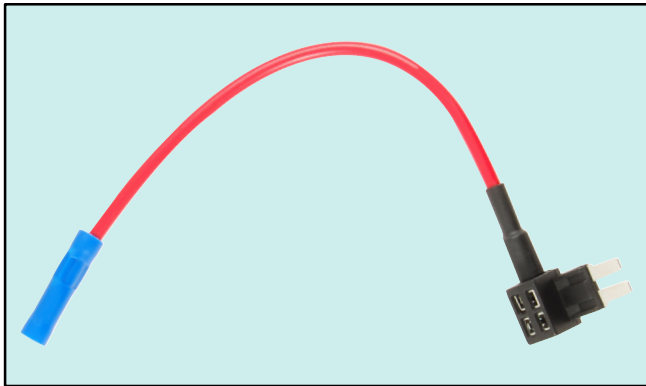

FA-16

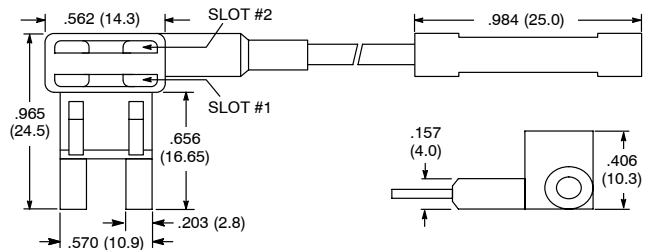

Description:

This device has slots for two fuses. SLOT #1 is for the fuse that was originally inside the panel. SLOT #2 is for the lead that is tapping off and is limited to 10 Amps max.

74-AFT-3, Automotive Fuse Circuit Tap for Low Profile Mini Blade Fuses

Specifications:

- Thin In-Line Fuse Holder Designed to Accommodate Two Fuses in One Slot
- For use with Low Profile Mini Fuse type Fuses.
- Max. Installation Rating: 15 Amps.
- Butt Splice Connectors Pull-Out Force: 15kg. Min.
- Cable Wire: #16AWG, 5" (127mm) Red Wire (UL1015)
- RoHS Compliant. Product not UL Listed.

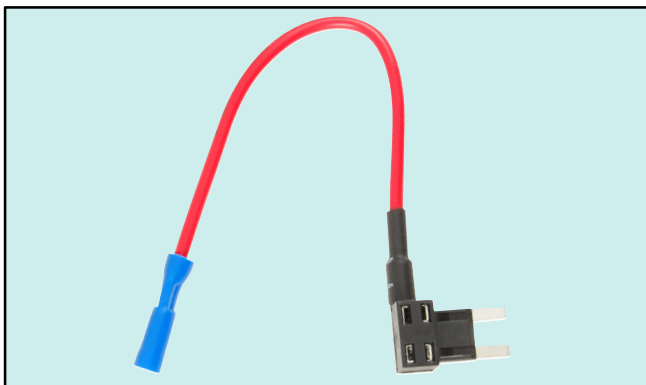

FA-17

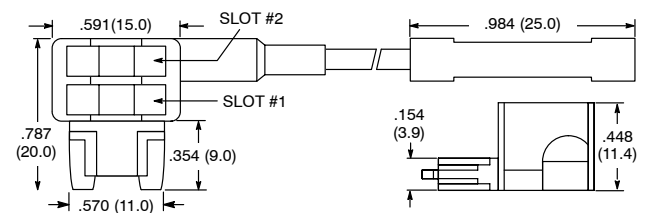

Description:

This device has slots for two fuses. SLOT #1 is for the fuse that was originally inside the panel. SLOT #2 is for the lead that is tapping off and is limited to 10 Amps max.

74-AFT-4, Automotive Fuse Circuit Tap for Micro-2 Blade Fuses

Specifications:

- Thin In-Line Fuse Holder Designed to Accommodate Two Fuses in One Slot
- For use with Micro-2 Blade Fuse type Fuses.
- Max. Installation Rating: 15 Amps.
- Butt Splice Connectors Pull-Out Force: 15kg. Min.
- Cable Wire: #16AWG, 5" (127mm) Red Wire (UL1015)
- RoHS Compliant. Product not UL Listed.

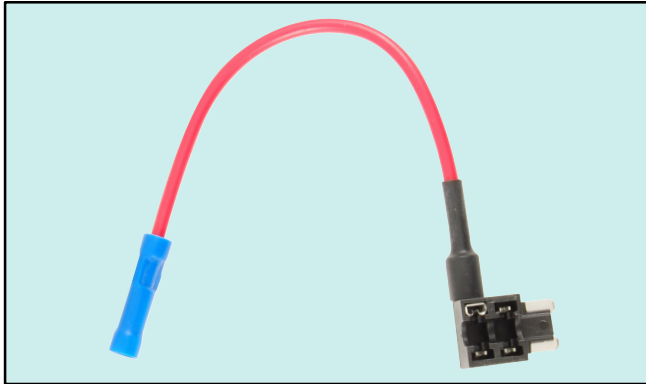

FA-18

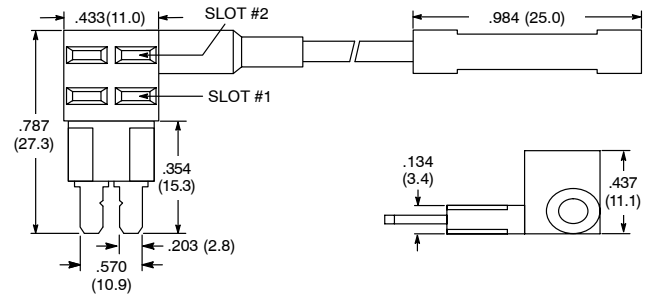

Description:

This device has slots for two fuses. SLOTT #1 is for the fuse that was originally inside the panel. SLOTT #2 is for the lead that is tapping off and is limited to 10 Amps max.