

Data sheet | Item number: 2002-2958

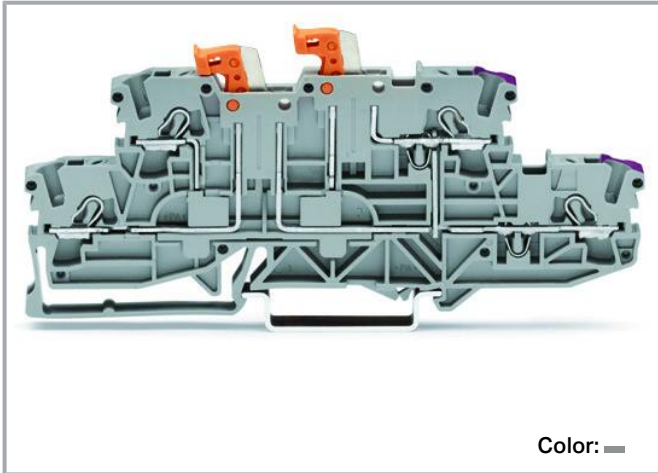

Double-deck, double-disconnect terminal block; with 2 pivoting knife disconnects; lower and upper decks internally commoned on right side; L/L; conductor entry with violet marking; for DIN-rail 35 x 15 and 35 x 7.5; 2.5 mm²; Push-in CAGE CLAMP®; 2,50 mm²; gray

www.wago.com/2002-2958



Color: —

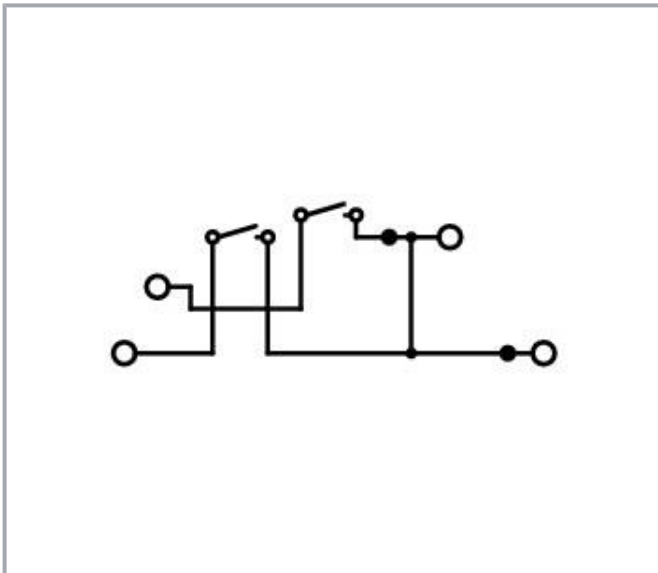
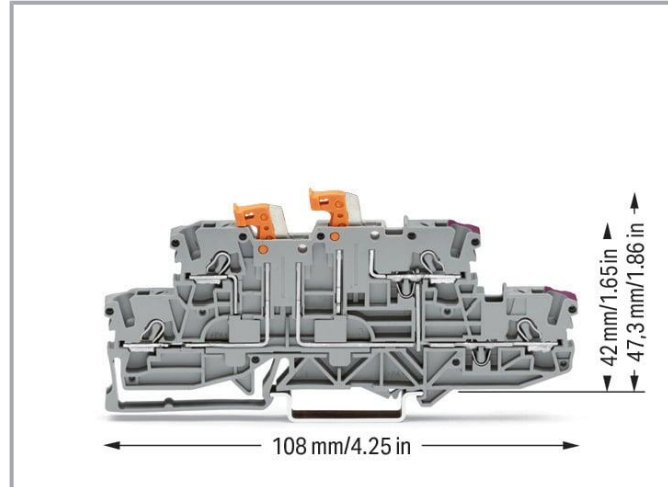

Data

Electrical data

Ratings per IEC/EN

Ratings per	IEC/EN 60947-7-1
Nominal voltage (III/3)	400 V

Subject to changes. Please also observe the further product documentation!

WAGO GmbH & Co. KG
Hansastr. 27
32423 Minden
Phone: +49571 887-0 | Fax: +49571 887-169
Email: info.de@wago.com | Web: www.wago.com

Do you have any questions about our products?
We are always happy to take your call at +49 (571) 887-44222.



Rated impulse voltage (III/3)	6 kV
Rated current	16 A
Legend (ratings)	(III / 3) $\hat{=}$ Overvoltage category III / Pollution degree 3

Ratings per UL 1059

Approvals per	UL 1059
Rated voltage UL (Use Group B)	300 V
Rated current UL (Use Group B)	15 A
Rated voltage UL (Use Group C)	300 V
Rated current UL (Use Group C)	15 A

Ratings per CSA

Approvals per	CSA 22.2 No 158
Rated voltage CSA (Use Group B)	300 V
Rated current CSA (Use Group B)	15 A
Rated voltage CSA (Use Group C)	150 V
Rated current CSA (Use Group C)	15 A
Rated voltage CSA (Use Group D)	300 V
Rated current CSA (Use Group D)	15 A

Ex information

Ratings per	ATEX: KIWA 17 ATEX 0030 U / IECEx: KIWA 17.0014U (Ex ec IIC Gc)
Rated voltage EN (Ex e II)	440 V
Rated current (Ex e II)	14 A

Power loss

Power loss, per pole (potential)	0.341 W
Rated current I_N for specified power loss	16 A
Resistance value for specified, current-dependent power loss	0.001 Ω

Connection data

Connection points	4
Total number of potentials	3
Number of levels	2
Number of jumper slots	2

Subject to changes. Please also observe the further product documentation!



Connection 1

Connection technology	Push-in CAGE CLAMP®
Actuation type	Operating tool
Connectable conductor materials	Copper
Nominal cross-section	2.5 mm ²
Solid conductor	0.25 ... 4 mm ² / 22 ... 12 AWG
Solid conductor; push-in termination	0.75 ... 4 mm ² / 18 ... 12 AWG
Fine-stranded conductor	0.25 ... 4 mm ² / 22 ... 12 AWG
Fine-stranded conductor; with insulated ferrule	0.25 ... 2.5 mm ² / 22 ... 14 AWG
Fine-stranded conductor; with ferrule; push-in termination	1 ... 2.5 mm ² / 18 ... 14 AWG
Note (conductor cross-section)	Depending on the conductor characteristic, a conductor with a smaller cross-section can also be inserted via push-in termination.
Strip length	10 ... 12 mm / 0.39 ... 0.47 inches
Wiring direction	Front-entry wiring

Physical data

Width	5.2 mm / 0.205 inches
Height	108 mm / 4.252 inches
Depth from upper-edge of DIN-rail	42 mm / 1.654 inches

Mechanical Data

Potential marking	L/L
Mounting type	DIN-35 rail
Marking level	Side marking

Material Data

Note (material data)	Information on material specifications can be found here
Color	gray
Material group	I
Insulation material	Polyamide (PA66)
Flammability class per UL94	V0
Fire load	0.316 MJ
Weight	17.7 g

Subject to changes. Please also observe the further product documentation!

Environmental requirements

Processing temperature	-35 ... +85 °C
Continuous operating temperature	-60 ... +105 °C

Commercial data





Product Group	22 (TOPJOB S)
eCl@ss 10.0	27-14-11-26
eCl@ss 9.0	27-14-11-26
ETIM 8.0	EC000902
ETIM 7.0	EC000902
PU (SPU)	50 pcs
Packaging type	box
Country of origin	CN
GTIN	4050821006770
Customs tariff number	85365080900

Environmental Product Compliance

RoHS Compliance Status	Compliant, No Exemption
------------------------	-------------------------

Approvals / Certificates

General approvals

Logo	Approval	Additional Approval Text	Certificate name
	CCA DEKRA Certification B.V.	EN 60947	71-120369
	CCA DEKRA Certification B.V.	EN 60947	NTR NL 7892
	CCC CNEX	GB/T 3836.3	2020312313000180 (Ex ec IIC Gc)
	CSA DEKRA Certification B.V.	C22.2 No. 158	1536069



Subject to changes. Please also observe the further product documentation!

	UL Underwriters Laboratories Inc.	UL 1059	E45172
--	--------------------------------------	---------	--------





Declarations of conformity and manufacturer's declarations

Logo	Approval	Additional Approval Text	Certificate name
	Railway WAGO GmbH & Co. KG	-	Railway Ready

Approvals for marine applications

Logo	Approval	Additional Approval Text	Certificate name
	ABS American Bureau of Shipping	EN 60947	20- HG1941090- PDA
	DNV GL Det Norske Veritas, Germanischer Lloyd	-	TAE00001V2

Approvals for hazardous areas

Logo	Approval	Additional Approval Text	Certificate name
	AEx Underwriters Laboratories Inc.	UL 60079	E185892 (AEx eb IIC resp. Ex eb IIC)
	ATEX KIWA Netherlands B.V.	EN 60079	KIWA 17ATEX0030 U
	CCC CNEX	GB/T 3836.3	2020312313000180 (Ex ec IIC Gc)
	IECEX KIWA Netherlands B.V.	EN 60079	IECEX KIWA 17.0014 U (Ex ec IIC Gc)



Subject to changes. Please also observe the further product documentation!

WAGO GmbH & Co. KG
Hansastr. 27
32423 Minden
Phone: +49571 887-0 | Fax: +49571 887-169
Email: info.de@wago.com | Web: www.wago.com

Do you have any questions about our products?
We are always happy to take your call at +49 (571) 887-44222.











Required accessories

End plate

End plate		
	Item no.: 2002-2991 End and intermediate plate; 1 mm thick; gray	www.wago.com/2002-2991
	Item no.: 2002-2992 End and intermediate plate; 1 mm thick; orange	www.wago.com/2002-2992

Optional accessories

Jumpers

Jumper		
	Item no.: 210-123 Wire commoning chain; insulated; blue	www.wago.com/210-123
	Item no.: 2002-402 Jumper; 2-way; insulated; light gray	www.wago.com/2002-402
	Item no.: 2002-402/000-005 Jumper; 2-way; insulated; red	www.wago.com/2002-402/000-005
	Item no.: 2002-400 Continuous jumper; 2-way; insulated; light gray	www.wago.com/2002-400
	Item no.: 2002-403 Jumper; 3-way; insulated; light gray	www.wago.com/2002-403
	Item no.: 2002-404/000-005 Jumper; 4-way; insulated; red	www.wago.com/2002-404/000-005
	Item no.: 2002-403/000-006 Jumper; 3-way; insulated; blue	www.wago.com/2002-403/000-006
	Item no.: 2002-404/000-006 Jumper; 4-way; insulated; blue	www.wago.com/2002-404/000-006
	Item no.: 2002-403/000-005 Jumper; 3-way; insulated; red	www.wago.com/2002-403/000-005
	Item no.: 2002-405/000-005 Jumper; 5-way; insulated; red	www.wago.com/2002-405/000-005

Subject to changes. Please also observe the further product documentation!



Item no.: 2002-402/000-006
Jumper; 2-way; insulated; blue

www.wago.com/2002-402/000-006



Item no.: 2002-405/000-006
Jumper; 5-way; insulated; blue

www.wago.com/2002-405/000-006



Item no.: 2002-404
Jumper; 4-way; insulated; light gray

www.wago.com/2002-404



Item no.: 2002-406/000-006
Jumper; 6-way; insulated; blue

www.wago.com/2002-406/000-006



Item no.: 2002-406/000-005
Jumper; 6-way; insulated; red

www.wago.com/2002-406/000-005



Item no.: 2002-406/020-000
Delta jumper; insulated; light gray

www.wago.com/2002-406/020-000



Item no.: 2002-405
Jumper; 5-way; insulated; light gray

www.wago.com/2002-405



Item no.: 2002-407/000-005
Jumper; 7-way; insulated; red

www.wago.com/2002-407/000-005



Item no.: 2002-408
Jumper; 8-way; insulated; light gray

www.wago.com/2002-408



Item no.: 2002-408/000-006
Jumper; 8-way; insulated; blue

www.wago.com/2002-408/000-006



Item no.: 2002-405/011-000
Star point jumper; 3-way; insulated; light gray

www.wago.com/2002-405/011-000



Item no.: 2002-407/000-006
Jumper; 7-way; insulated; blue

www.wago.com/2002-407/000-006

Subject to changes. Please also observe the further product documentation!



Item no.: 2002-408/000-005
Jumper; 8-way; insulated; red

www.wago.com/2002-408/000-005



Item no.: 2002-407
Jumper; 7-way; insulated; light gray

www.wago.com/2002-407



Item no.: 2002-406
Jumper; 6-way; insulated; light gray

www.wago.com/2002-406



Item no.: 2002-410/000-005
Jumper; 10-way; insulated; red

www.wago.com/2002-410/000-005



Item no.: 2002-410/000-006
Jumper; 10-way; insulated; blue

www.wago.com/2002-410/000-006



Item no.: 2002-410
Jumper; 10-way; insulated; light gray

www.wago.com/2002-410



Item no.: 2002-409/000-006
Jumper; 9-way; insulated; blue

www.wago.com/2002-409/000-006



Item no.: 2002-409/000-005
Jumper; 9-way; insulated; red

www.wago.com/2002-409/000-005



Item no.: 2002-409
Jumper; 9-way; insulated; light gray

www.wago.com/2002-409



Item no.: 2002-423/000-006
Continuous jumper; from 1 to 3; insulated; blue

www.wago.com/2002-423/000-006



Item no.: 2002-423
Continuous jumper; from 1 to 3; insulated; light gray

www.wago.com/2002-423



Item no.: 2002-433
Jumper; from 1 to 3; insulated; light gray

www.wago.com/2002-433

















Item no.: 2002-434
Jumper; from 1 to 4; insulated; light gray

www.wago.com/2002-434



Subject to changes. Please also observe the further product documentation!

	<p>Item no.: 2002-423/000-005 Continuous jumper; from 1 to 3; insulated; red</p>	<p>www.wago.com/2002-423/000-005</p>
	<p>Item no.: 2002-435 Jumper; from 1 to 5; insulated; light gray</p>	<p>www.wago.com/2002-435</p>
	<p>Item no.: 2002-436 Jumper; from 1 to 6; insulated; light gray</p>	<p>www.wago.com/2002-436</p>
	<p>Item no.: 2002-437 Jumper; from 1 to 7; insulated; light gray</p>	<p>www.wago.com/2002-437</p>
	<p>Item no.: 2002-438 Jumper; from 1 to 8; insulated; light gray</p>	<p>www.wago.com/2002-438</p>
	<p>Item no.: 2002-439 Jumper; from 1 to 9; insulated; light gray</p>	<p>www.wago.com/2002-439</p>
	<p>Item no.: 2002-440 Jumper; from 1 to 10; insulated; light gray</p>	<p>www.wago.com/2002-440</p>
	<p>Item no.: 2002-472 Staggered jumper; 2-way; insulated; light gray</p>	<p>www.wago.com/2002-472</p>
	<p>Item no.: 2002-473 Staggered jumper; 3-way; insulated; light gray</p>	<p>www.wago.com/2002-473</p>
	<p>Item no.: 2002-475/011-000 Staggered jumper; 3-way; insulated; light gray</p>	<p>www.wago.com/2002-475/011-000</p>
	<p>Item no.: 2002-475 Staggered jumper; 5-way; insulated; light gray</p>	<p>www.wago.com/2002-475</p>
	<p>Item no.: 2002-476 Staggered jumper; 6-way; insulated; light gray</p>	<p>www.wago.com/2002-476</p>
	<p>Item no.: 2002-474 Staggered jumper; 4-way; insulated; light gray</p>	<p>www.wago.com/2002-474</p>
	<p>Item no.: 2002-477 Staggered jumper; 7-way; insulated; light gray</p>	<p>www.wago.com/2002-477</p>
	<p>Item no.: 2002-473/011-000 Staggered jumper; 2-way; from 1 to 3; insulated; light gray</p>	<p>www.wago.com/2002-473/011-000</p>
	<p>Item no.: 2002-479 Staggered jumper; 9-way; insulated; light gray</p>	<p>www.wago.com/2002-479</p>

Subject to changes. Please also observe the further product documentation!



Item no.: 2002-478
Staggered jumper; 8-way; insulated; light gray

www.wago.com/2002-478



Item no.: 2002-479/011-000
Staggered jumper; insulated; light gray

www.wago.com/2002-479/011-000



Item no.: 2002-480
Staggered jumper; 10-way; insulated; light gray

www.wago.com/2002-480



Item no.: 2002-477/011-000
Staggered jumper; insulated; light gray

www.wago.com/2002-477/011-000



Item no.: 2002-481/011-000
Staggered jumper; insulated; light gray

www.wago.com/2002-481/011-000



Item no.: 2002-481
Staggered jumper; 11-way; insulated; light gray

www.wago.com/2002-481



Item no.: 2002-482
Staggered jumper; 12-way; insulated; light gray

www.wago.com/2002-482



Item no.: 210-103
Wire commoning chain; insulated; black

www.wago.com/210-103



Item no.: 2002-424/000-006
Continuous jumper; from 1 to 4; insulated; blue

www.wago.com/2002-424/000-006

Mounting

Cover carrier



Item no.: 709-169
Cover carrier; Type 3; gray

www.wago.com/709-169

Cover



Item no.: 709-156
Cover; Type 3; suitable for cover carrier, type 3; 1 m long; transparent

www.wago.com/709-156

Tool

Operating tool



Item no.: 210-658
Operating tool; Blade: 3.5 x 0.5 mm; with a partially insulated shaft; angled; short; multicoloured

www.wago.com/210-658

Subject to changes. Please also observe the further product documentation!



Item no.: 210-720

Operating tool; Blade: 3.5 x 0.5 mm; with a partially insulated shaft; multicoloured

www.wago.com/210-720

Carrier rail

Mounting accessories



Item no.: 210-197

Steel carrier rail; 35 x 15 mm; 1.5 mm thick; 2 m long; slotted; similar to EN 60715; silver-colored

www.wago.com/210-197



Item no.: 210-198

Copper carrier rail; 35 x 15 mm; 2.3 mm thick; 2 m long; unslotted; according to EN 60715; copper-colored

www.wago.com/210-198



Item no.: 210-504

Steel carrier rail; 35 x 7.5 mm; 1 mm thick; 2 m long; slotted; galvanized; according to EN 60715; silver-colored

www.wago.com/210-504



Item no.: 210-505

Steel carrier rail; 35 x 7.5 mm; 1 mm thick; 2 m long; unslotted; galvanized; according to EN 60715; silver-colored

www.wago.com/210-505

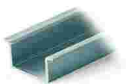

Item no.: 210-506

Steel carrier rail; 35 x 15 mm; 1.5 mm thick; 2 m long; unslotted; galvanized; similar to EN 60715; silver-colored

www.wago.com/210-506



Item no.: 210-508

Steel carrier rail; 35 x 15 mm; 1.5 mm thick; 2 m long; slotted; galvanized; similar to EN 60715; silver-colored

www.wago.com/210-508



Item no.: 210-113

Steel carrier rail; 35 x 7.5 mm; 1 mm thick; 2 m long; unslotted; according to EN 60715; silver-colored

www.wago.com/210-113

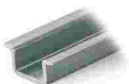

Item no.: 210-118

Steel carrier rail; 35 x 15 mm; 2.3 mm thick; 2 m long; unslotted; according to EN 60715; silver-colored

www.wago.com/210-118



Item no.: 210-112

Steel carrier rail; 35 x 7.5 mm; 1 mm thick; 2 m long; slotted; according to EN 60715; "Hole width 25 mm; silver-colored

www.wago.com/210-112



Item no.: 210-114

Steel carrier rail; 35 x 15 mm; 1.5 mm thick; 2 m long; unslotted; similar to EN 60715; silver-colored

www.wago.com/210-114



Item no.: 210-115

Steel carrier rail; 35 x 7.5 mm; 1 mm thick; 2 m long; slotted; according to EN 60715; "Hole width 18 mm; silver-colored

www.wago.com/210-115



Item no.: 210-196

Aluminum carrier rail; 35 x 8.2 mm; 1.6 mm thick; 2 m long; unslotted; similar to EN 60715; silver-colored

www.wago.com/210-196

Testing and measuring

Testing accessories



Item no.: 2009-174

www.wago.com/2009-174

Subject to changes. Please also observe the further product documentation!

Test plug adapter; for 4 mm Ø test plugs; for testing TOPJOB®S rail-mounted terminal blocks; gray



Item no.: 2009-182

Testing tap; for max. 2.5 mm²; tool-free connection for individual test wires 0.08 - 2.5 mm; gray

www.wago.com/2009-182



Item no.: 2002-511

Modular TOPJOB®S connector; modular; for jumper contact slot; 1-pole; 2,50 mm²; gray

www.wago.com/2002-511



Item no.: 2002-549

Spacer module; modular; e.g., for bridging commoned terminal blocks; gray

www.wago.com/2002-549



Item no.: 2002-552

Modular TOPJOB®S connector; modular; for jumper contact slot; 2-pole; 2,50 mm²; gray

www.wago.com/2002-552



Item no.: 2002-558

Modular TOPJOB®S connector; modular; for jumper contact slot; 8-pole; 2,50 mm²; gray

www.wago.com/2002-558



Item no.: 2002-559

Modular TOPJOB®S connector; modular; for jumper contact slot; 9-pole; 2,50 mm²; gray

www.wago.com/2002-559



Item no.: 2002-556

Modular TOPJOB®S connector; modular; for jumper contact slot; 6-pole; 2,50 mm²; gray

www.wago.com/2002-556



Item no.: 2002-553

Modular TOPJOB®S connector; modular; for jumper contact slot; 3-pole; 2,50 mm²; gray

www.wago.com/2002-553



Item no.: 2002-611

TOPJOB®S L-type test plug module; modular; 1-pole; 2,50 mm²; gray

www.wago.com/2002-611



Item no.: 2002-560

Modular TOPJOB®S connector; modular; for jumper contact slot; 10-pole; 2,50 mm²; gray

www.wago.com/2002-560



Item no.: 2002-554

Modular TOPJOB®S connector; modular; for jumper contact slot; 4-pole; 2,50 mm²; gray

www.wago.com/2002-554



Item no.: 2002-555

Modular TOPJOB®S connector; modular; for jumper contact slot; 5-pole; 2,50 mm²; gray

www.wago.com/2002-555



Item no.: 2002-557

Modular TOPJOB®S connector; modular; for jumper contact slot; 7-pole; 2,50 mm²; gray

www.wago.com/2002-557



Item no.: 2002-649

TOPJOB®S L-type spacer module; modular; e.g., for bridging commoned terminal blocks; gray

www.wago.com/2002-649



Item no.: 210-136

Test plug; 2 mm Ø; with 500 mm cable; red

www.wago.com/210-136

Protective warning marker

Cover

Subject to changes. Please also observe the further product documentation!

WAGO GmbH & Co. KG

Hansastr. 27

32423 Minden

Phone: +49571 887-0 | Fax: +49571 887-169

Email: info.de@wago.com | Web: www.wago.com

Do you have any questions about our products?

We are always happy to take your call at +49 (571) 887-44222.



Item no.: 2002-115

Protective warning marker; for 5 terminal blocks; with high-voltage symbol, black; yellow

www.wago.com/2002-115

Insulation stop

Insulation stop



Item no.: 2002-171

Insulation stop; 0.25 - 0.5 mm²; 5 pieces/strip; light gray

www.wago.com/2002-171



Item no.: 2002-172

Insulation stop; 0.75 - 1 mm²; 5 pieces/strip; dark gray

www.wago.com/2002-172

Marking accessories

Marking strip



Item no.: 2009-110

Marking strips; for Smart Printer; on reel; not stretchable; plain; snap-on type; white

www.wago.com/2009-110

Marker carrier



Item no.: 2009-198

Adaptor; gray

www.wago.com/2009-198



Item no.: 2002-160

Adaptor; gray

www.wago.com/2002-160

Marker



Item no.: 2009-115/000-002

WMB-Inline; for Smart Printer; 1500 pieces on roll; stretchable 5 - 5.2 mm; plain; snap-on type; yellow

www.wago.com/2009-115/000-002



Item no.: 2009-115/000-007

WMB-Inline; for Smart Printer; 1500 pieces on roll; stretchable 5 - 5.2 mm; plain; snap-on type; gray

www.wago.com/2009-115/000-007



Item no.: 2009-115/000-017

WMB-Inline; for Smart Printer; 1500 pieces on roll; stretchable 5 - 5.2 mm; plain; snap-on type; light green

www.wago.com/2009-115/000-017



Item no.: 2009-115/000-023

WMB-Inline; for Smart Printer; 1500 pieces on roll; stretchable 5 - 5.2 mm; plain; snap-on type; green

www.wago.com/2009-115/000-023



Item no.: 2009-115/000-024

WMB-Inline; for Smart Printer; 1500 pieces on roll; stretchable 5 - 5.2 mm; plain; snap-on type; violet

www.wago.com/2009-115/000-024



Item no.: 2009-145/000-006

Mini-WSB Inline; for Smart Printer; 1700 pieces on roll; stretchable 5 - 5.2 mm; plain; snap-on type; blue

www.wago.com/2009-145/000-006

Subject to changes. Please also observe the further product documentation!

WAGO GmbH & Co. KG

Hansastr. 27









32423 Minden

Phone: +49571 887-0 | Fax: +49571 887-169

Email: info.de@wago.com | Web: www.wago.com

Do you have any questions about our products?

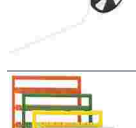
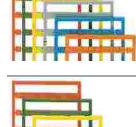
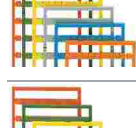
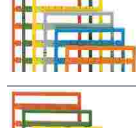
We are always happy to take your call at +49 (571) 887-44222.

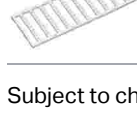
	<p>Item no.: 2009-145 Mini-WSB Inline; for Smart Printer; 1700 pieces on roll; stretchable 5 - 5.2 mm; plain; snap-on type; white</p>	www.wago.com/2009-145
	<p>Item no.: 2009-145/000-002 Mini-WSB Inline; for Smart Printer; 1700 pieces on roll; stretchable 5 - 5.2 mm; plain; snap-on type; yellow</p>	www.wago.com/2009-145/000-002
	<p>Item no.: 2009-145/000-007 Mini-WSB Inline; for Smart Printer; 1700 pieces on roll; stretchable 5 - 5.2 mm; plain; snap-on type; gray</p>	www.wago.com/2009-145/000-007
	<p>Item no.: 2009-145/000-005 Mini-WSB Inline; for Smart Printer; 1700 pieces on roll; stretchable 5 - 5.2 mm; plain; snap-on type; red</p>	www.wago.com/2009-145/000-005
	<p>Item no.: 2009-145/000-012 Mini-WSB Inline; for Smart Printer; 1700 pieces on roll; stretchable 5 - 5.2 mm; plain; snap-on type; orange</p>	www.wago.com/2009-145/000-012
	<p>Item no.: 2009-145/000-023 Mini-WSB Inline; for Smart Printer; 1700 pieces on roll; stretchable 5 - 5.2 mm; plain; snap-on type; green</p>	www.wago.com/2009-145/000-023
	<p>Item no.: 2009-145/000-024 Mini-WSB Inline; for Smart Printer; 1700 pieces on roll; stretchable 5 - 5.2 mm; plain; snap-on type; violet</p>	www.wago.com/2009-145/000-024
	<p>Item no.: 2009-115 WMB-Inline; for Smart Printer; 1500 pieces on roll; stretchable 5 - 5.2 mm; plain; snap-on type; white</p>	www.wago.com/2009-115
	<p>Item no.: 248-501/000-006 Mini-WSB marking card; as card; not stretchable; plain; snap-on type; blue</p>	www.wago.com/248-501/000-006
	<p>Item no.: 248-501/000-007 Mini-WSB marking card; as card; not stretchable; plain; snap-on type; gray</p>	www.wago.com/248-501/000-007
	<p>Item no.: 248-501/000-002 Mini-WSB marking card; as card; not stretchable; plain; snap-on type; yellow</p>	www.wago.com/248-501/000-002
	<p>Item no.: 248-501/000-012 Mini-WSB marking card; as card; not stretchable; plain; snap-on type; orange</p>	www.wago.com/248-501/000-012
	<p>Item no.: 248-501 Mini-WSB marking card; as card; not stretchable; plain; snap-on type; white</p>	www.wago.com/248-501

Subject to changes. Please also observe the further product documentation!



Item no.: 248-501/000-017
Mini-WSB marking card; as card; not stretchable; plain; snap-on type; light green

www.wago.com/248-501/000-017



Item no.: 248-501/000-005
Mini-WSB marking card; as card; not stretchable; plain; snap-on type; red

www.wago.com/248-501/000-005



Item no.: 248-501/000-024
Mini-WSB marking card; as card; not stretchable; plain; snap-on type; violet

www.wago.com/248-501/000-024



Item no.: 248-501/000-023
Mini-WSB marking card; as card; not stretchable; plain; snap-on type; green

www.wago.com/248-501/000-023



Item no.: 793-5501/000-007
WMB marking card; as card; for terminal block width 5 - 17.5 mm; stretchable 5 - 5.2 mm; plain; snap-on type; gray

www.wago.com/793-5501/000-007



Item no.: 793-5501/000-012
WMB marking card; as card; for terminal block width 5 - 17.5 mm; stretchable 5 - 5.2 mm; plain; snap-on type; orange

www.wago.com/793-5501/000-012



Item no.: 793-5501/000-014
WMB marking card; as card; for terminal block width 5 - 17.5 mm; stretchable 5 - 5.2 mm; plain; snap-on type; brown

www.wago.com/793-5501/000-014



Item no.: 793-5501/000-017
WMB marking card; as card; for terminal block width 5 - 17.5 mm; stretchable 5 - 5.2 mm; plain; snap-on type; light green

www.wago.com/793-5501/000-017



Item no.: 793-5501/000-023
WMB marking card; as card; for terminal block width 5 - 17.5 mm; stretchable 5 - 5.2 mm; plain; snap-on type; green

www.wago.com/793-5501/000-023



Item no.: 793-5501/000-024
WMB marking card; as card; for terminal block width 5 - 17.5 mm; stretchable 5 - 5.2 mm; plain; snap-on type; violet

www.wago.com/793-5501/000-024



Item no.: 793-5501/000-005
WMB marking card; as card; for terminal block width 5 - 17.5 mm; stretchable 5 - 5.2 mm; plain; snap-on type; red

www.wago.com/793-5501/000-005

Subject to changes. Please also observe the further product documentation!

**Item no.:** 793-5501/000-002

WMB marking card; as card; for terminal block width 5 - 17.5 mm; stretchable 5 - 5.2 mm; plain; snap-on type; yellow

www.wago.com/793-5501/000-002**Item no.:** 793-5501/000-006

WMB marking card; as card; for terminal block width 5 - 17.5 mm; stretchable 5 - 5.2 mm; plain; snap-on type; blue

www.wago.com/793-5501/000-006**Item no.:** 793-5501

WMB marking card; as card; for terminal block width 5 - 17.5 mm; stretchable 5 - 5.2 mm; plain; snap-on type; white

www.wago.com/793-5501**Item no.:** 2009-115/000-012

WMB-Inline; for Smart Printer; 1500 pieces on roll; stretchable 5 - 5.2 mm; plain; snap-on type; orange

www.wago.com/2009-115/000-012**Item no.:** 2009-115/000-006

WMB-Inline; for Smart Printer; 1500 pieces on roll; stretchable 5 - 5.2 mm; plain; snap-on type; blue

www.wago.com/2009-115/000-006**Item no.:** 2009-115/000-005

WMB-Inline; for Smart Printer; 1500 pieces on roll; stretchable 5 - 5.2 mm; plain; snap-on type; red

www.wago.com/2009-115/000-005**Group marker carrier****Item no.:** 2009-193

Group marker carrier; gray

www.wago.com/2009-193**Item no.:** 2009-192

Group marker carrier; gray

www.wago.com/2009-192**Item no.:** 2009-191

Group marker carrier; gray

www.wago.com/2009-191**End plate**

End plate

**Item no.:** 209-192

Separator for Ex e/Ex i applications; 3 mm thick; 125.5 mm wide; orange

www.wago.com/209-192**Push-in type wire jumper**

Jumper

**Item no.:** 2009-412

Push-in type wire jumper; insulated; 60 mm long; black

www.wago.com/2009-412**Item no.:** 2009-414Push-in type wire jumper; 1.5 mm²; insulated; 110 mm long; blackwww.wago.com/2009-414**Item no.:** 2009-416Push-in type wire jumper; 1.5 mm²; insulated; 250 mm long; blackwww.wago.com/2009-416

Subject to changes. Please also observe the further product documentation!

WAGO GmbH & Co. KG

Hansastr. 27

32423 Minden

Phone: +49571 887-0 | Fax: +49571 887-169

Email: info.de@wago.com | Web: www.wago.com

Do you have any questions about our products?

We are always happy to take your call at +49 (571) 887-44222.



Item no.: 2009-414/000-005
Push-in type wire jumper; 1.5 mm²; insulated; 110 mm long; black

www.wago.com/2009-414/000-005











Item no.: 2009-414/000-006
Push-in type wire jumper; insulated; 110 mm long; black

www.wago.com/2009-414/000-006

Ferrule

Ferrule

	Item no.: 216-241 Ferrule; Sleeve for 0.5 mm ² / 20 AWG; insulated; electro-tin plated; electrolytic copper; gastight crimped; acc. to DIN 46228, Part 4/09.90; white	www.wago.com/216-241
	Item no.: 216-242 Ferrule; Sleeve for 0.75 mm ² / 18 AWG; insulated; electro-tin plated; electrolytic copper; gastight crimped; acc. to DIN 46228, Part 4/09.90; gray	www.wago.com/216-242
	Item no.: 216-243 Ferrule; Sleeve for 1 mm ² / AWG 18; insulated; electro-tin plated; electrolytic copper; gastight crimped; acc. to DIN 46228, Part 4/09.90; red	www.wago.com/216-243
	Item no.: 216-244 Ferrule; Sleeve for 1.5 mm ² / AWG 16; insulated; electro-tin plated; electrolytic copper; gastight crimped; acc. to DIN 46228, Part 4/09.90; black	www.wago.com/216-244
	Item no.: 216-263 Ferrule; Sleeve for 1 mm ² / AWG 18; insulated; electro-tin plated; electrolytic copper; gastight crimped; acc. to DIN 46228, Part 4/09.90; red	www.wago.com/216-263
	Item no.: 216-246 Ferrule; Sleeve for 2.5 mm ² / AWG 14; insulated; electro-tin plated; electrolytic copper; gastight crimped; acc. to DIN 46228, Part 4/09.90; blue	www.wago.com/216-246
	Item no.: 216-266 Ferrule; Sleeve for 2.5 mm ² / AWG 14; insulated; electro-tin plated; electrolytic copper; gastight crimped; acc. to DIN 46228, Part 4/09.90; blue	www.wago.com/216-266
	Item no.: 216-264 Ferrule; Sleeve for 1.5 mm ² / AWG 16; insulated; electro-tin plated; electrolytic copper; gastight crimped; acc. to DIN 46228, Part 4/09.90; black	www.wago.com/216-264
	Item no.: 216-262 Ferrule; Sleeve for 0.75 mm ² / 18 AWG; insulated; electro-tin plated; electrolytic copper; gastight crimped; acc. to DIN 46228, Part 4/09.90; gray	www.wago.com/216-262

Downloads

Documentation

Bid Text

2002-2958 X81 - Datei	2019 Apr 18	xml 4.2 kB	Download
2002-2958 docx - Datei	2019 Apr 18	docx 15.8 kB	Download

Subject to changes. Please also observe the further product documentation!

WAGO GmbH & Co. KG
Hansastr. 27
32423 Minden
Phone: +49571 887-0 | Fax: +49571 887-169
Email: info.de@wago.com | Web: www.wago.com

Do you have any questions about our products?
We are always happy to take your call at +49 (571) 887-44222.



Additional Information

Technical Section	pdf	Download
Technical explanations	2.2 MB	

CAD/CAE-Data

CAD data

2D/3D Models 2002-2958	URL	Download
------------------------	-----	----------

CAE data

EPLAN Data Portal 2002-2958	URL	Download
-----------------------------	-----	----------

WSCAD Universe 2002-2958	URL	Download
--------------------------	-----	----------

ZUKEN Portal 2002-2958	URL	Download
------------------------	-----	----------

Environmental Product Compliance

Compliance Search

Environmental Product Compliance 2002-2958	URL	Download
--	-----	----------

Double-deck, double-disconnect terminal block; with 2 pivoting knife disconnects; lower and upper decks internally commoned on right side; L/L; conductor entry with violet marking; for DIN-rail 35 x 15 and 35 x 7.5; 2.5 mm²; Push-in CAGE CLAMP®; 2,50 mm²; gray

Installation Notes

Testing

Subject to changes. Please also observe the further product documentation!

WAGO GmbH & Co. KG
Hansastr. 27
32423 Minden
Phone: +49571 887-0 | Fax: +49571 887-169
Email: info.de@wago.com | Web: www.wago.com

Do you have any questions about our products?
We are always happy to take your call at +49 (571) 887-44222.

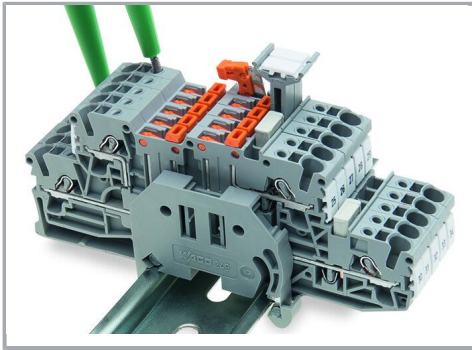

Testing with voltage tester.

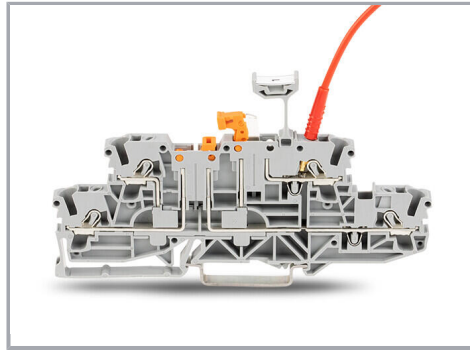

Double-deck, double-disconnect terminal block (2002-2951) with group marker carrier (2002-160) accommodated in a jumper contact slot and test plug (210-136)

Marking

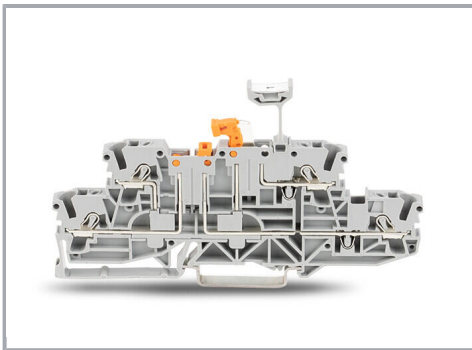

Double-deck, double-disconnect terminal block (2002-2951) with group marker carrier (2002-160) accommodated in jumper contact slot

Product family

TOPJOB® S

TOPJOB® S: In various industrial applications and modern building installations, WAGO's wide and versatile range of rail-mount terminal blocks provides more than just reliable electrical connections.

[Show all products from the family](#)

Subject to changes. Please also observe the further product documentation!