

**PLEASE CHECK WWW.MOLEX.COM FOR LATEST PART INFORMATION**

**Part Number:** [52893-2895](#)  
**Status:** **Active**  
**Overview:** FFC-FPC (SMT)  
**Description:** Easy-On™ Type FFC/FPC Connector, Right Angle, SMT, ZIF, Bottom Contact Style, 28 Circuits, Lead-Free

**Documents:**

[3D Model](#) [Packaging Specification SPK-52893-001 \(PDF\)](#)  
[Drawing \(PDF\)](#) [RoHS Certificate of Compliance \(PDF\)](#)  
[Product Specification PS-52892-038 \(PDF\)](#)

**Agency Certification**

UL E29179

**General**

Product Family	FFC/FPC Connectors
Series	<a href="#">52893</a>
Comments	Hinge
Overview	<a href="#">FFC-FPC (SMT)</a>
Product Name	Easy-On™
UPC	822348120956

  

<b>Physical</b>	
Circuits (Loaded)	28
Circuits (maximum)	28
Color - Resin	Natural
Contact Position	Bottom
Durability (mating cycles max)	20
Entry Angle	90° Angle
Flammability	94V-0
Mated Height	2.00mm
Material - Metal	Phosphor Bronze
Material - Plating Mating	Tin-Bismuth
Material - Plating Termination	Tin-Bismuth
Material - Resin	High Temperature Thermoplastic
Net Weight	291.600/mg
Number of Rows	1
Orientation	Right Angle
PCB Locator	No
PCB Retention	Yes
Packaging Type	Embossed Tape on Reel
Pitch - Mating Interface	0.50mm
Pitch - Termination Interface	0.50mm
Plating min - Mating	1.016µm
Plating min - Termination	1.016µm
Polarized to PCB	No
Stackable	No
Temperature Range - Operating	-20°C to +85°C
Termination Interface: Style	Surface Mount
Wire/Cable Type	FFC/FPC

**Electrical**

Current - Maximum per Contact 0.5A  
Voltage - Maximum 50V

**Material Info**

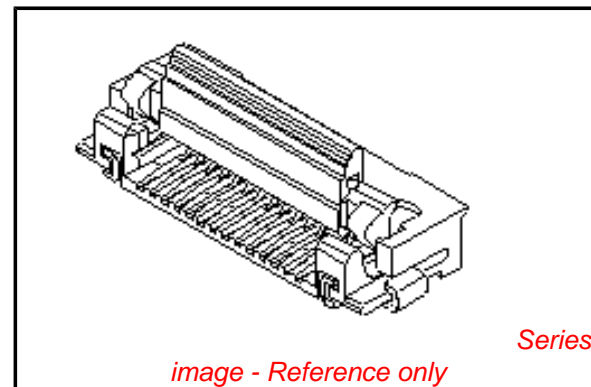

**EU RoHS**

**ELV and RoHS Compliant**  
**REACH SVHC Contains SVHC: No**  
**Low-Halogen Status Not Low-Halogen**

**China RoHS**



**Need more information on product environmental compliance?**

Email [productcompliance@molex.com](mailto:productcompliance@molex.com)  
For a multiple part number RoHS Certificate of Compliance, [click here](#)

Please visit the [Contact Us](#) section for any non-product compliance questions.

**Search Parts in this Series**

[52893Series](#)

## Reference - Drawing Numbers

Packaging Specification

Product Specification

Sales Drawing

SPK-52893-001

PS-52892-038, RPS-52892-045, RPS-52892-052,

RPS-52892-055

SD-52893-040, SD-52893-041

This document was generated on 04/28/2014

**PLEASE CHECK [WWW.MOLEX.COM](http://WWW.MOLEX.COM) FOR LATEST PART INFORMATION**