

Data sheet | Item number: 855-4001/100-001

Split-core current transformer; Primary rated current: 100 A; Secondary rated current: 1 A; Rated power: 0.2 VA; Accuracy class: 1; Cable length: 3 m

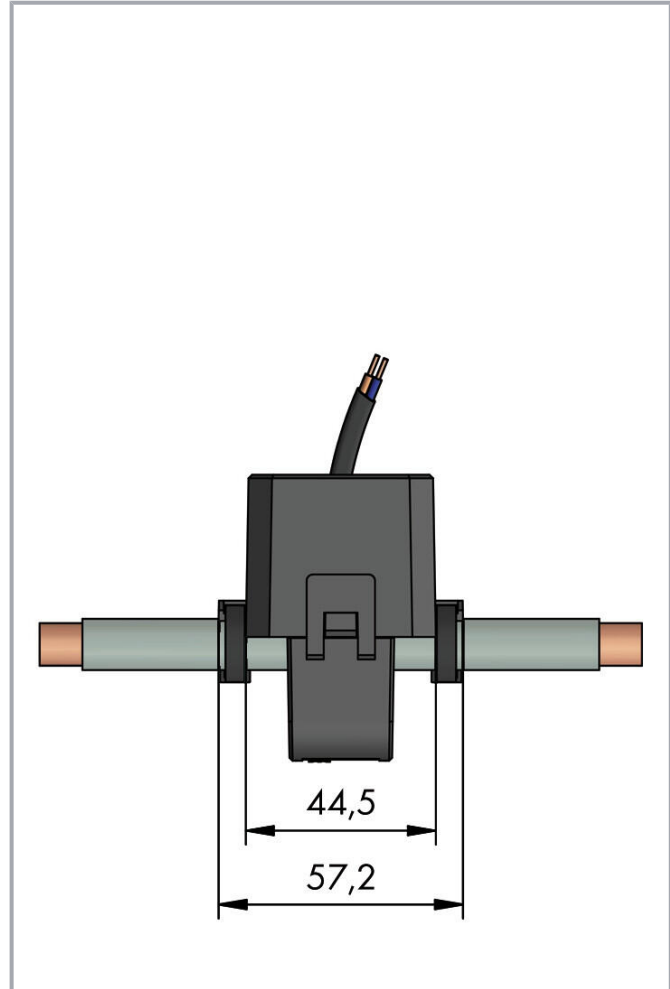

www.wago.com/855-4001/100-001



Subject to changes. Please also observe the further product documentation!

WAGO GmbH & Co. KG
Hansastr. 27
32423 Minden
Phone: +49571 887-0 | Fax: +49571 887-169
Email: info.de@wago.com | Web: www.wago.com

Do you have any questions about our products?
We are always happy to take your call at +49 (571) 887-44222.

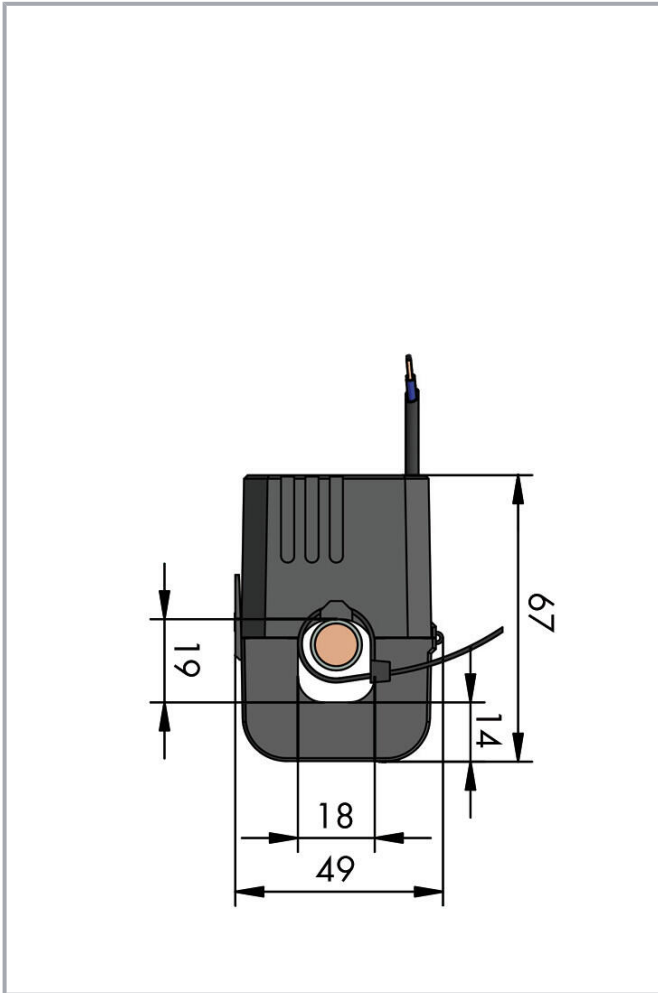

Item description

Short description:

WAGO's compact split-core current transformers are ideal for retrofitting existing systems. They are perfect for applications in which the current path must not be disrupted. The transformer's accuracy permits extremely precise current measurements. The split-core current transformers are capable of supplying the specified rated power at the end of the secondary cable. All transformers are supplied with color-coded cables. Two UV-resistant cable ties are also included for secure and easy mounting.

Features:

- Current ratios from 100 A (primary side) and 1 A (secondary side)
- No primary cable interruption
- Ideal for use in very confined spaces
- Rapid mounting

Subject to changes. Please also observe the further product documentation!



- For use around insulated cables up to 18 mm diameter
- Compact and hinged
- Color-coded connection cable (3 m)

Data

Technical data

Input Current Transformers

Primary rated current	100 A
Rated continuous thermal current I_{cth}	100 %
Rated short-time thermal current I_{th}	$60 \times I_N / 1 \text{ s}$
Rated surge current I_{dyn}	$2.5 \times I_{th}$
Rated frequency	50 ... 60 Hz

Output (current transformer)

Secondary rated current	1 A
Rated power S_r	0.2 VA

Measurement Error

Accuracy class	1
----------------	---

Safety and protection

Highest voltage for equipment U_m	AC 720 V _{rms}
Protection type	IP20

Test voltage

Test voltage	AC 3 kV; 50 Hz; 1 min
--------------	-----------------------

Connection data

Feedthrough for measurement conductor	Ø 18 mm
Cable type	2 x 0.5 mm ² ; fine-stranded
Color code	Brown = S1; blue = S2

Subject to changes. Please also observe the further product documentation!



Physical data

Cable length	3 m
--------------	-----

Mechanical Data

Mounting type	Split-core current transformer (suspended)
---------------	--

Material Data

Flammability class per UL94	V2
Weight	412 g

Environmental requirements

Ambient temperature (operation)	-10 ... +55 °C
Ambient temperature (storage)	-20 ... +70 °C
Relative humidity	5 ... 85 % (without condensation)
Operating altitude (max.)	2000 m

Standards and specifications

Conformity marking	CE
Standards/specifications	EN 61869-1 EN 61869-2

Commercial data

eCl@ss 10.0	27-21-09-02
eCl@ss 9.0	27-21-09-02
ETIM 8.0	EC002048
ETIM 7.0	EC002048
PU (SPU)	1 pcs
Packaging type	box
Country of origin	NL
GTIN	4050821880578
Customs tariff number	85043180888

Environmental Product Compliance

RoHS Compliance Status	Compliant, No Exemption
------------------------	-------------------------

Subject to changes. Please also observe the further product documentation!

Approvals / Certificates





General approvals

Logo	Approval	Additional Approval Text	Certificate name
	EAC Brjansker Zertifizierungsstelle	TP TC 004/2011, TP TC 020/2011	EAC RU C-DE.AM02. B.00111 /19

Optional accessories

Mounting

Current transformer terminal block



	Item no.: 2007-8874 Compact terminal block; for current and voltage transformers; 6,00 mm ² ; multicoloured	www.wago.com/2007-8874
	Item no.: 2007-8877 Compact terminal block; for current transformer circuit; 6,00 mm ² ; multicoloured	www.wago.com/2007-8877
	Item no.: 2007-8875 Compact terminal block; for current transformer circuit; 6,00 mm ² ; multicoloured	www.wago.com/2007-8875
	Item no.: 2007-8876 Compact terminal block; for 3-phase current transformer circuit; 6,00 mm ² ; multicoloured	www.wago.com/2007-8876
	Item no.: 2007-8873 Compact terminal block; for current and voltage transformers; 6,00 mm ² ; multicoloured	www.wago.com/2007-8873

Signal conditioner

Power measurement module

	Item no.: 2857-570/024-001 3-Phase Power Measurement Module; 3x277/480 V/1 A; Modbus RTU; Digital output; Configuration via software; Supply voltage: 24 VDC	www.wago.com/2857-570/024-001
--	--	--

Current signal conditioner

	Item no.: 857-550 Current signal conditioner; Current input signal; Current and voltage output signal; Digital output; Configuration via software; Supply voltage: 24 VDC; 6 mm module width; 2,50 mm ²	www.wago.com/857-550
	Item no.: 857-551	

Subject to changes. Please also observe the further product documentation!

Current signal conditioner; Current input signal; Current and voltage output signal; Digital output;
Configuration via software; Supply voltage: 24 VDC; 6 mm module width

www.wago.com/857-551

Downloads

Documentation

Bid Text

855-4001/100-001 X81 - Datei	2019 Feb 19	xml 5.3 kB	Download
---------------------------------	-------------	---------------	----------

855-4001/100-001 doc - Datei	2015 Feb 5	doc 30.7 kB	Download
---------------------------------	------------	----------------	----------

Instruction Leaflet

Kabelumbau-Stromwandler	V 1.1.0 2020 Jan 15	pdf 832.5 kB	Download
-------------------------	------------------------	-----------------	----------

Additional Information

Disposal and Recycling Electrical and electronic equipment, Batteries, Packaging	V 1.1.0 2022 Aug 18	pdf 2.2 MB	Download
---	------------------------	---------------	----------

Engineering-Software

Configuration and Commissioning Software

WAGO Interface Configuration Software G2 FULL The full setup, in addition to the WAGO Interface Configuration Software G2, includes the installation for the Microsoft .NET Framework.	1.00.10.01 2022 Jan 20	exe 114.9 MB	Download
---	---------------------------	-----------------	----------

Environmental Product Compliance

Compliance Search

Environmental Product Compliance 855-4001/100-001 Split-core current transformer; Primary rated current: 100 A; Secondary rated current: 1 A; Rated power: 0.2 VA; Accuracy class: 1; Cable length: 3 m	URL	Download
--	-----	----------

Installation Notes

Installation

Subject to changes. Please also observe the further product documentation!

WAGO GmbH & Co. KG
Hansastr. 27
32423 Minden
Phone: +49571 887-0 | Fax: +49571 887-169
Email: info.de@wago.com | Web: www.wago.com

Do you have any questions about our products?
We are always happy to take your call at +49 (571) 887-44222.



Simple termination!



Quick and easy mounting!



Subject to changes. Please also observe the further product documentation!