



Since 1959

Product Information Sheet

HB3 (9005) 12V 65W

9005

2014. 03. 08 NEW

2009. 05. 12 OLD

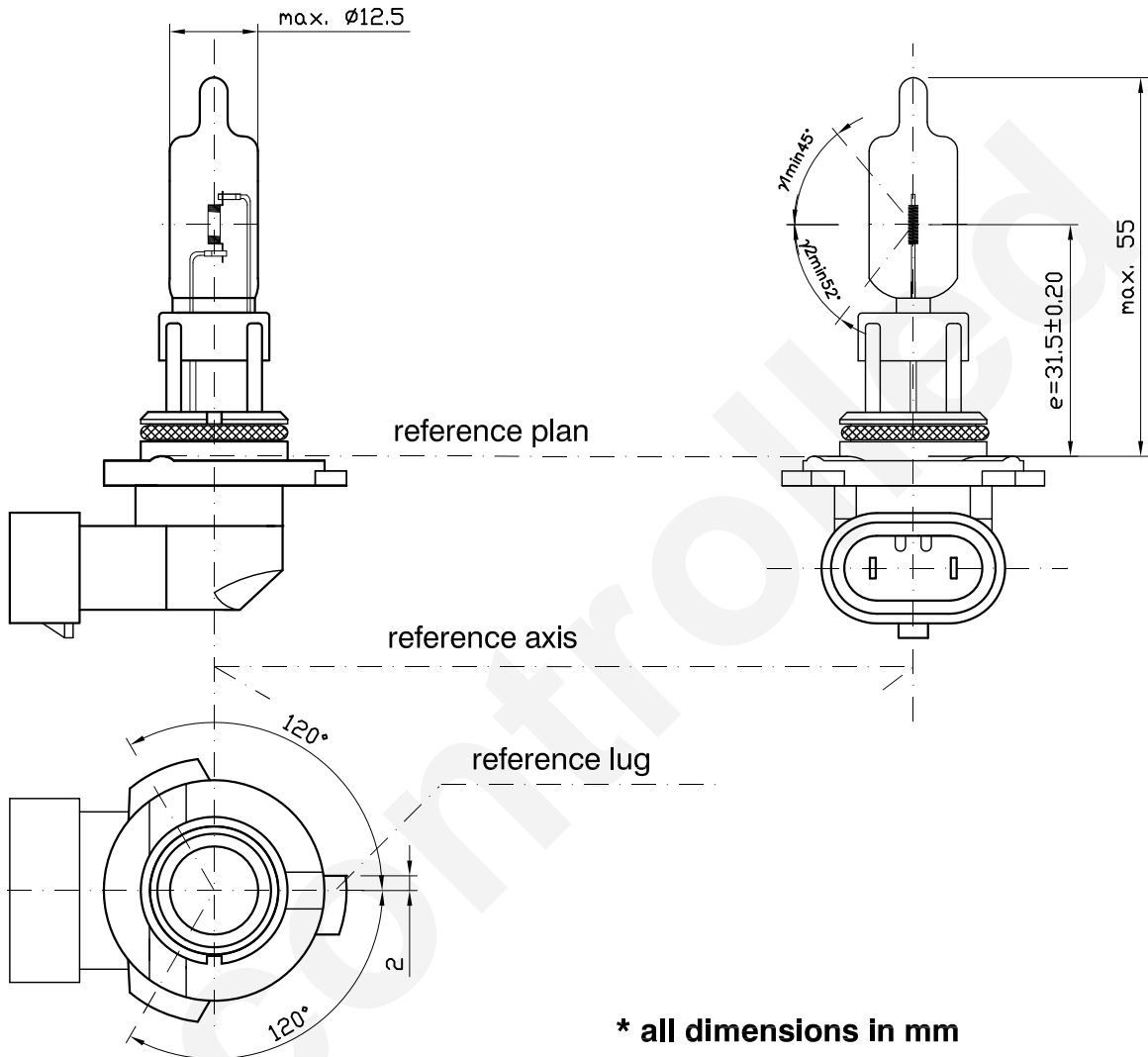

* all dimensions in mm

Halogen bulb
HB3 12V 65W
Cap: ¹⁾ P20d
Type: 9005
ECE R37 (E1) 2A17
FMVSS 108 DOT
Bulb mat.: Hardglass
Made in china / JDH

1) according to IEC 61-1 sheet 7004-31-1

Technical data	R37	FMVSS108
Test voltage	13.2V	12.8V
Power	73W max	70W max
Luminous flux	1860lm $\pm 12\%$	1700lm $\pm 12\%$
Lumen maintenance	90 % min	90 % min
Rated life:	at 13.2V	at 14.0V
- characteristic Tc	300 h min	- Average
-B3	150 h min	150 hr

Maximum operating temperature:	bulb 650°C max pinch 400°C max
Operating position	vertical