

INFINITY
Power Connectors

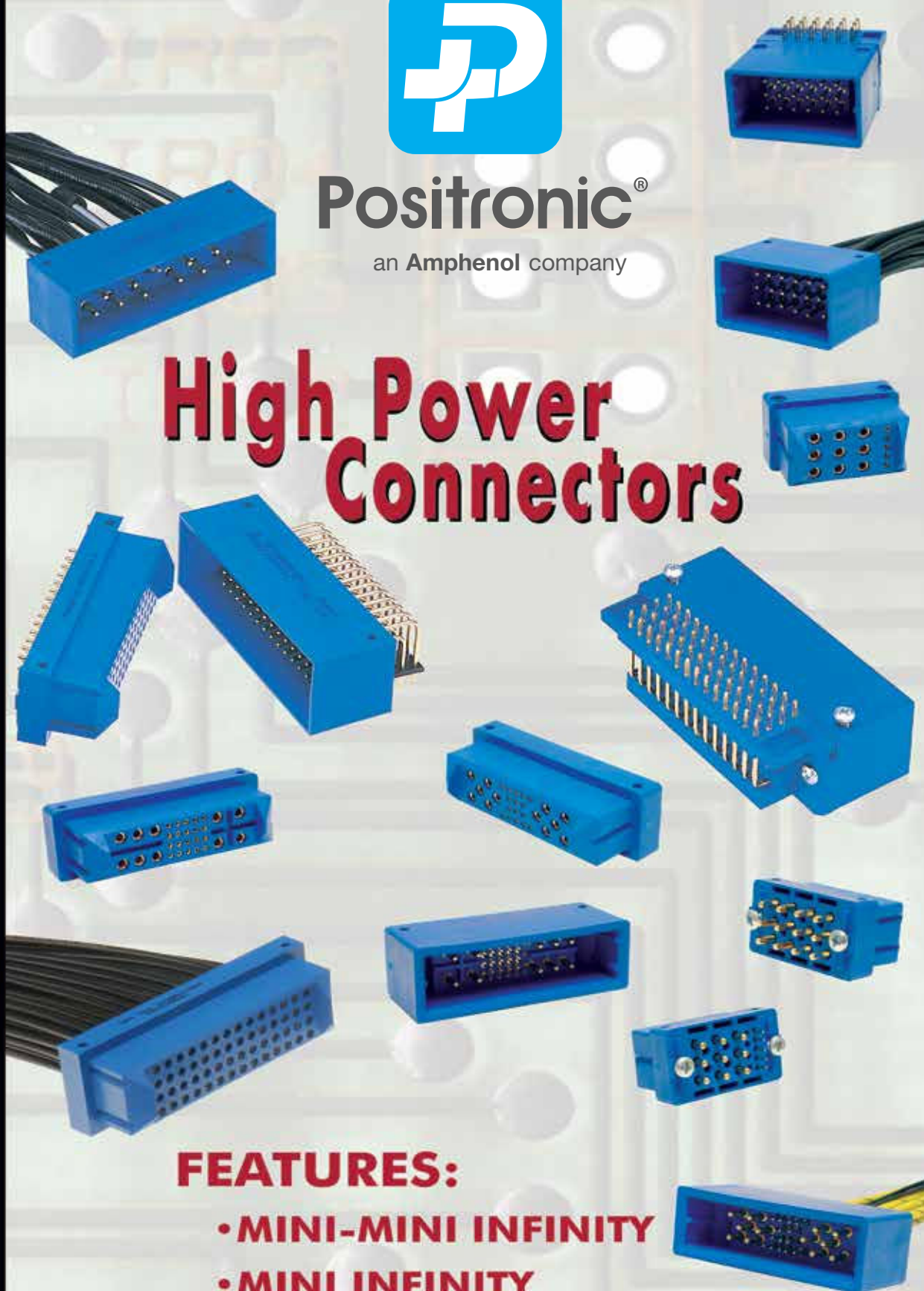

Positronic[®]
an Amphenol company

High Power Connectors



FEATURES:

- MINI-MINI INFINITY
- MINI INFINITY
- INFINITY

ABOUT US

Founded in 1966, Positronic Industries is a vertically integrated manufacturer of high quality interconnect products. Positronic has earned the worldwide reputation as a service oriented, quick-reaction, top quality connector supplier. We are committed to maintaining this reputation by continuous implementation of our **Complete Capability** concept.

COMPLETE CAPABILITY

Design & Development

- Designs new connectors and modifies existing connectors to meet industry requirements
- Continuously conducts marketing studies to identify industry needs for new products
- Ongoing interest in unique connector designs

Tooling

- Tooling support for all manufacturing areas within company
- Provides 80% of new tooling, punch press dies, molds, jigs and fixtures used at Positronic factory locations worldwide

Machining

- Automatic screw machines produce finely crafted contacts and hardware for connector bodies
- Trained technicians operate machines from Tornos, Bechler and Brown & Sharpe

Molding

- Molds all plastic connector components such as insulators, hoods, angle brackets and more
- Overmold capability available

Plating

- Applies gold and other metal finishes to connector components to any required thickness
- Plating conforms to all military specifications

Quality Assurance Lab

- Quality assurance system certified to ISO 9001. Soon certification to AS9100!
- Maintains aggressive TQM program
- Able to test to IEC, EIA, UL, MIL-DTL-24308, MIL-DTL-28748, SAE AS 39029 and MIL-C-85049 requirements

Finished Stock Inventory

- Each main factory location maintains a large inventory of connector components and accessories
- Same day shipments available on many standard connector products
- Stocking agreements available for qualified customers

Worldwide Sales & Service

- Responsive attitude toward customer needs
- Fully trained sales staff located worldwide
- Facilities located in USA, France, India, Puerto Rico, and Singapore.



Machining



Molding



Finished Stock Inventory

Products described within this catalog may be protected by one or more of the following US. patents:

#4,900,261 #5,255,580 #5,329,697
#6,260,268 #6,835,079 #7,115,002

Patented in Canada, 1992 Other Patents Pending

Unless otherwise specified, **dimensional tolerances** are:

- 1) ± 0.03 mm [0.001 inches] for male contact mating diameters.
- 2) ± 0.08 mm [0.003 inches] for contact termination diameters.
- 3) ± 0.13 mm [0.005 inches] for all other diameters.
- 4) ± 0.38 mm [0.015 inches] for all other dimensions.

Information in this catalog is proprietary to Positronic and its subsidiaries. Positronic believes the data contained herein to be reliable. Since the technical information is given free of charge, the user employs such information at his own discretion and risk. Positronic Industries assumes no responsibility for results obtained or damages incurred from use of such information in whole or in part.

Positronic Industries' FEDERAL SUPPLY CODE (Cage Code) FOR MANUFACTURERS is 28198

POSITRONIC IS AN ITAR REGISTERED COMPANY

Positronic Industries is proud to participate in the important work of the following organizations....



PICMG® and PICMG® logo are registered trademarks of the PCI Industrial Computers Manufacturers Group.

www.picmg.com



The Multinational Power Electronics Association

www.pasma.com

POSITRONIC CABLIZED CONNECTORS

SAVE TIME AND MONEY! Let Positronic support your connector requirements by cablizing your **Power** connector selection. Positronic offers technical support and manufacturing capability for cablized connectors. Contact your factory direct sales representative for details!

Quality Assurance



Engineering Management



Design and Testing Service

Positronic Industries' Engineering Department:

1. Works closely with customers.
2. Prepares component and cablized connector systems, hardware design, and performance specifications.
3. Designs each system in accordance with applicable customer, domestic, and international standards.
4. Defines and directs required performance and verification testing.

Springfield Cable Assembly



Puerto Rico Cable Assembly



Connectors Designed To Customer Specifications

Positronic connectors can be modified to customers specifications.

Examples: select loading of contacts for cost savings or to gain creepage and clearance distances; longer PCB terminations; customer specified hardware.

Positronic can develop and tool new connector designs with reasonable price and delivery.

Contact Technical Sales with your particular requirements.

INFINITY

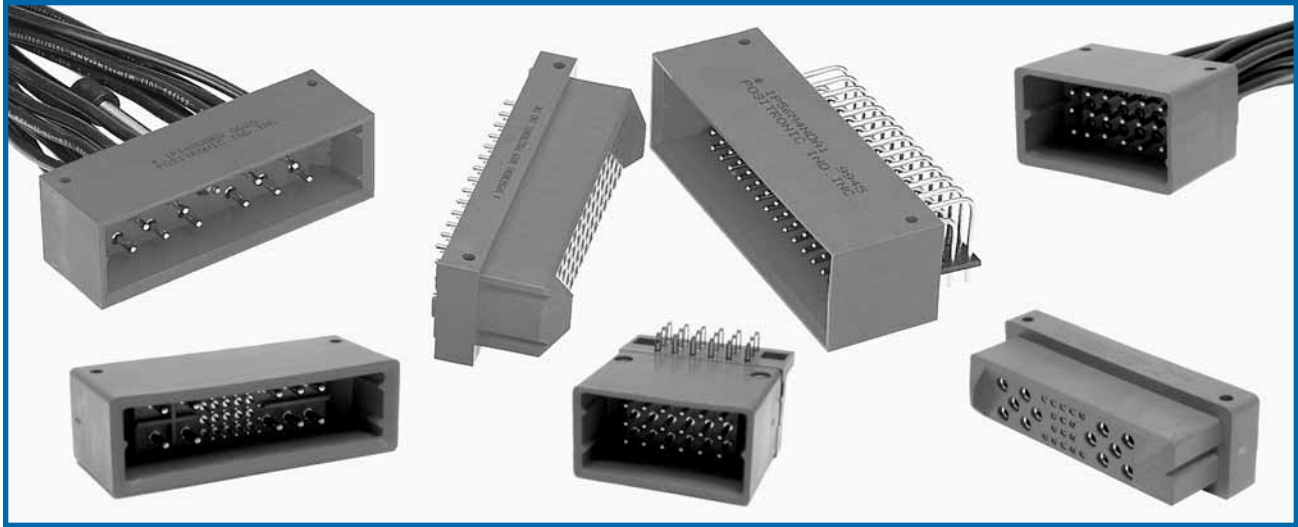

HIGH POWER CONNECTION SYSTEMS FEATURE:

The Infinity High Power Connector series is offered to the electronics industry as a high power interface with a wide variety of features. The exceptional features of this series provide solutions for system design challenges created by increasing power consumption. Notable features include:

- Solid machined true power contacts which provide superior power density
- Single contact ratings up to 40 amperes continuous for Infinity series and up to 100 amperes continuous for Mini Infinity series.
- Hot-plug capability
- Outstanding blind mating
- Sequential contact mating options
- A.C. or D.C. Input
- Recessed female contacts for safety considerations
- Multiple power contacts provide efficient current distribution for multi-voltage centralized power applications
- Multiple power contacts can be paralleled together for single voltage distributed power applications
- A wide variety of options, termination styles and contact variations
- U.L and C.S.A recognition



**RoHS Compliant
options available!**

These outstanding features make the Infinity an excellent choice as a power interface for many power applications including telecom, datacom, and computing platforms.



Positronic Industries
connectpositronic.com

TABLE OF CONTENTS

Infinity
High Power
Connector

G E N E R A L I N F O R M A T I O N

| | |
|---|-----|
| Connection Systems | 1-2 |
| Demystifying Current Ratings | 3 |
| Large Surface Area Contact Mating System | 4 |
| Compliant Press-Fit Terminations | 5 |
| Blind Mating System and Sequential Mating System | 6 |
| Application Specific Arrangements | 7 |
| Application Specific Arrangements and General Product Information | 8 |

M M I P S E R I E S

| | |
|--|----|
| Technical Characteristics | 9 |
| Contact Variants and Connector Mating Dimensions | 10 |
| Connector Outline Dimensions and Cable Connector | 11 |
| Straight Solder Board Mount Connector and Contact Hole Patterns | 12 |
| Straight Compliant Press-Fit Board Mount Connectors and Contact Hole Patterns | 13 |
| Right Angle (90°) Solder Board Mount Connectors and Contact Hole Patterns | 14 |
| Right Angle (90°) Compliant Press-Fit Board Mount Connectors and Contact Hole Patterns | 15 |
| Ordering Information Page | 16 |



M I P S E R I E S

| | |
|--|----|
| Technical Characteristics | 17 |
| Contact Variants | 18 |
| Temperature Rise Curves and Connector Mating Dimensions | 19 |
| Connector Outline Dimensions and Cable Connector | 20 |
| Straight Solder Board Mount Connector | 21 |
| Straight Solder Board Mount Connector Contact Hole Patterns | 22 |
| Straight Compliant Press-Fit Board Mount Connectors | 23 |
| Straight Compliant Press-Fit Board Mount Connectors Contact Hole Patterns | 24 |
| Right Angle (90°) Solder Board Mount Connectors | 25 |
| Right Angle (90°) Solder Board Mount Connectors Contact Hole Patterns | 26 |
| Right Angle (90°) Compliant Press-Fit Board Mount Connectors and Contact Hole Patterns | 27 |
| Ordering Information Page | 28 |



I P S E R I E S

| | |
|--|----|
| Technical Characteristics | 29 |
| Contact Variants | 30 |
| Temperature Rise Curves and Connector Mating Dimensions | 31 |
| Connector Outline Dimensions and Cable Connector  | 32 |
| Straight Solder Board Mount Connector | 33 |
| Straight Solder Board Mount Connector Contact Hole Patterns | 34 |
| Straight Compliant Press-Fit Board Mount Connectors | 35 |
| Straight Compliant Press-Fit Board Mount Connectors Contact Hole Patterns | 36 |
| Right Angle (90°) Solder Board Mount Connectors | 37 |
| Right Angle (90°) Solder Board Mount Connectors Contact Hole Patterns | 38 |
| Right Angle (90°) Compliant Press-Fit Board Mount Connectors and Contact Hole Patterns | 39 |
| Ordering Information Page | 40 |



R E M O V A B L E C O N T A C T S

| | |
|--|----|
| Removable Contact Technical Information | 41 |
| Removable Contact Technical Information and Removable Crimp Contact Size 20 | 42 |
| Removable Crimp Contact Size 16 and Removable Solder Cup Contact Size 16 | 43 |
| Removable Crimp Contact Size 12 and Removable Solder Cup Contact Size 12 | 44 |
| Removable Crimp Contact Size 8 | 45 |
| Removable 100 amp High Current Crimp Contact Size 8 and Removable Solder Cup Contact Size 8 | 46 |
| Removable High Voltage Contact Size 8 | 47 |
| Removable Shielded Contacts Size 8 | 48 |



A P P L I C A T I O N T O O L S

| | |
|--|-------|
| Crimping Information For Removable Crimp Contacts | 49-50 |
| Soldering and Crimping Information For Shielded Contacts | 51 |
| Crimping Tools and Accessories | 52 |
| Contact Application Tools Cross Reference List | 53-54 |
| Press-Fit User Information and Mounting Screws | 55 |
| Compliant Press-Fit Termination Connector Installation Tools | 56 |
| Compliant Press-Fit Connectors Printed Hole Sizes | 57 |



A C C E S S O R I E S

| | |
|---|----|
| Panel Mounting Plate With Floating Bushings, Floating Bushings Panel Mount Cutout and Direct Mounting Panel Cutout | 58 |
| Connector Mounting Style Options, Panel Float Mount and Float Mount Panel Cutout | 59 |
| Cable Adapters and Fixed Female Jackscrew | 60 |
| Rotating Male Jackscrew | 61 |



REMOVABLE CONTACTS

APPLICATION TOOLS

ACCESSORIES



Positronic Industries
connectpositronic.com

CONNECTION SYSTEMS

Infinity
High Power
Connector

◆ SYSTEM 1 ◆

MOTHER BOARD
DAUGHTER BOARD

FEMALE:
Straight Solder or
Press-Fit Contacts

Typical Part Numbers:
MIP30F300A1 - Straight Mount
IP56F300A1 - Straight Mount

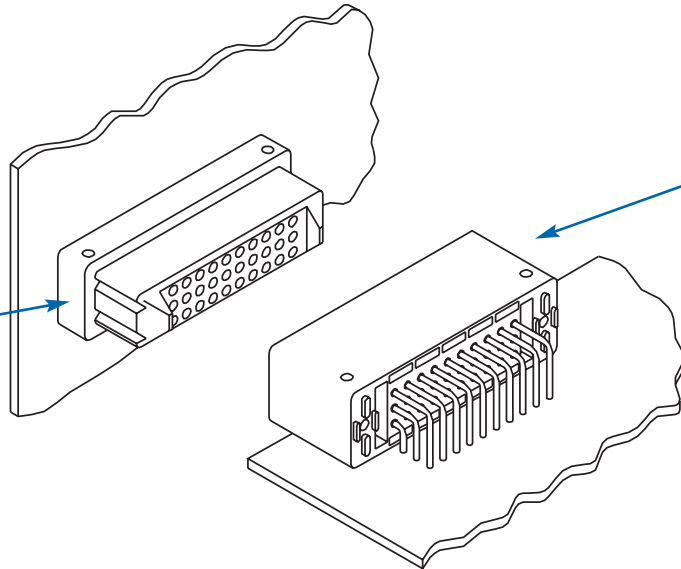

MALE:
Right Angle (90°) Solder
Contacts

Typical Part Numbers:

MIP30M400A1
IP56M400A1
Right Angle (90°) Press-Fit contacts
available for MIP30, MMIP18, and
IP56 variant connectors

*** NOTE:**

Crimp removable contacts must be ordered separately. See pages 41-48 of this catalog for ordering information.

◆ SYSTEM 2 ◆

PANEL MOUNT TO
RIGHT ANGLE (90°) BOARD MOUNT

*** FEMALE:**
Crimp Contacts Installed
(*contacts ordered separately)

Typical Part Numbers:
MIP30F00830 with FC116N2
IP33W9F0H00 with
FC116N2 and FC612N2

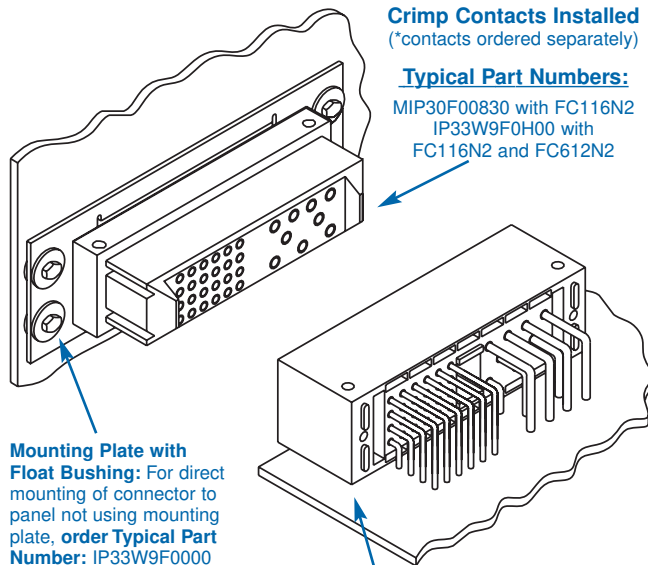

**Mounting Plate with
Float Bushing:** For direct
mounting of connector to
panel not using mounting
plate, order **Typical Part
Number:** IP33W9F0000

Float mount options
available, see pages
58 & 59.

MALE:
Right Angle (90°) Solder
Contacts

Typical Part Numbers:
MIP30M400A1
IP33W9M400A1
Right Angle (90°) Press-Fit contacts available for
MIP30, MMIP18, IP48 and IP56 variant connectors

◆ SYSTEM 3 ◆

CABLE TO RIGHT ANGLE
(90°) BOARD MOUNT

*** MALE:**
Crimp Contacts Installed
(*contacts ordered separately)

Typical Part Numbers:
MIP30M0000 with MC116N
IP48M00E0 with MC116N

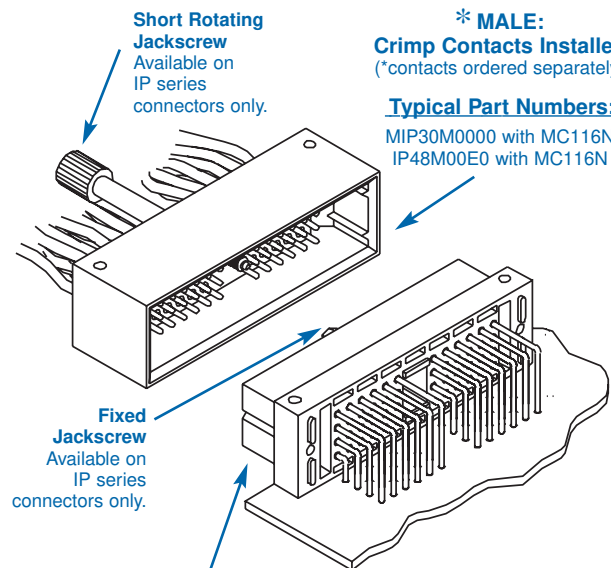

**Short Rotating
Jackscrew**
Available on
IP series
connectors only.

**Fixed
Jackscrew**
Available on
IP series
connectors only.

FEMALE:
Right Angle (90°) Solder
Contacts

Typical Part Numbers:
MIP30F400A1
IP48F40TA1
Right Angle (90°) Press-Fit contacts available for
MIP30, MMIP18, IP48, and IP56 variant connectors

◆ **SYSTEM 4** ◆

CABLE TO STRAIGHT BOARD MOUNT

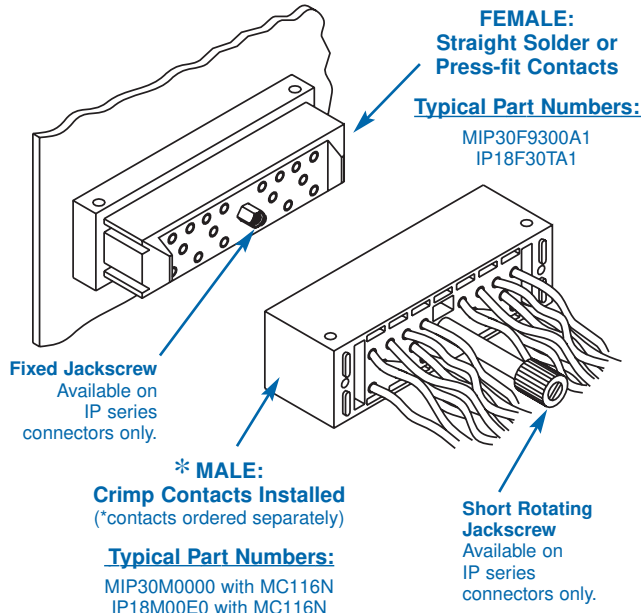

◆ **SYSTEM 5** ◆

CABLE TO CABLE CRIMP CONTACTS

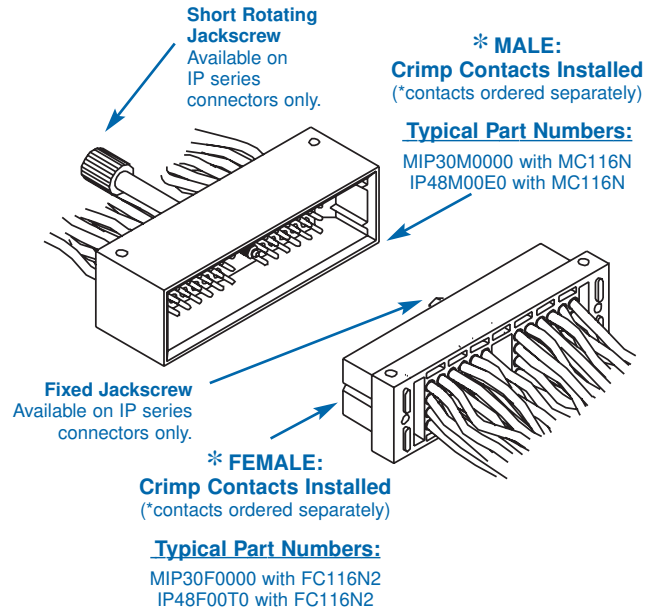

* **NOTE:**

Crimp removable contacts must be ordered separately. See pages 41-48 of this catalog for ordering information.

◆ **SYSTEM 6** ◆

PANEL MOUNT TO CABLE CONNECTOR WITH CABLE ADAPTER AND LONG ROTATING JACKSCREW
AVAILABLE ON IP SERIES CONNECTORS ONLY

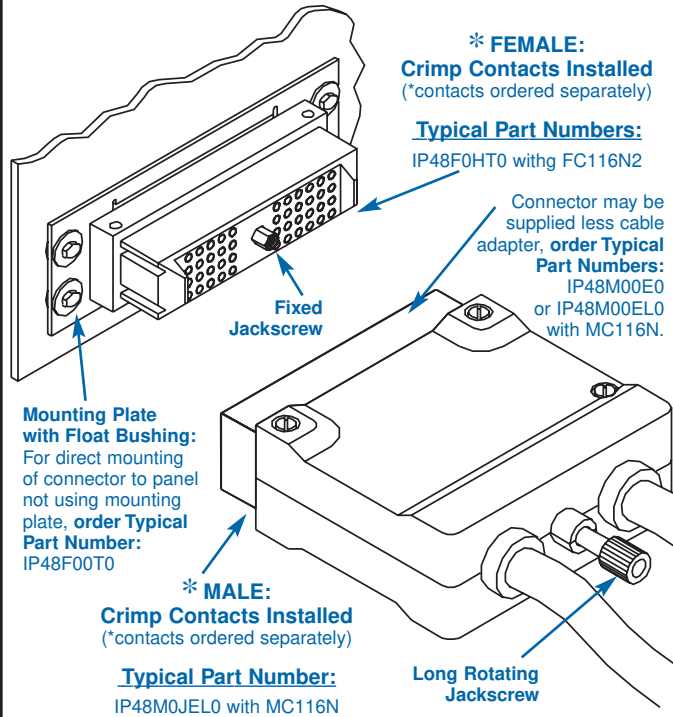

◆ **SYSTEM 7** ◆

RIGHT ANGLE (90°) BOARD MOUNT TO RIGHT ANGLE (90°) BOARD MOUNT

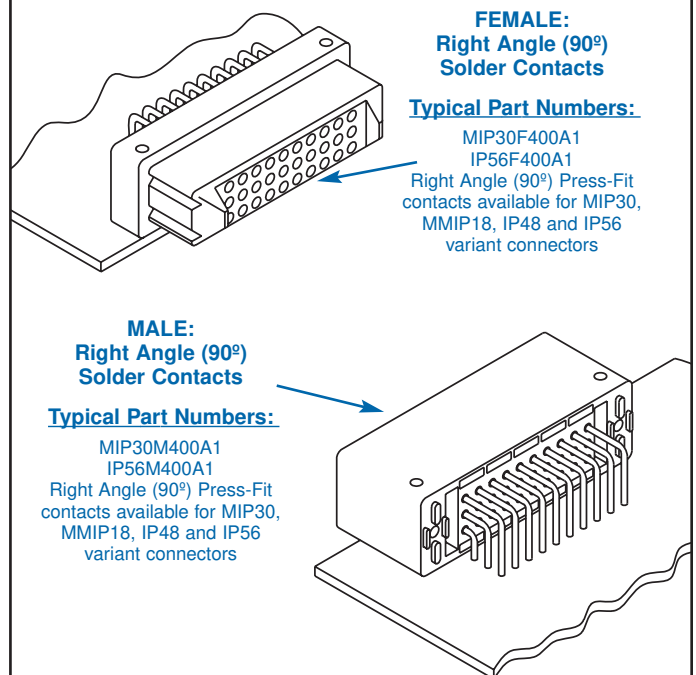



DEMYSTIFYING CURRENT RATINGS

Connector current ratings seem to be shrouded in mystery at times. The user wonders how a listed current rating is relevant to a particular application. Perhaps more mysterious is how similar connectors from various manufacturers list different current rating values. While it is true that material choices and design can enhance a connector's current rating, the test method by which the rating was developed must be understood when evaluations are made.

Users of connectors for power applications are entitled to current rating test details in order to make an informed choice. Ideally, a connector's current rating should be developed within the application for which it is being considered. Although ideal, this approach is not always practical given the many differing applications. In order for connector manufacturers to give potential product users an idea of what can be expected, connectors are given current ratings based on a specific test method.

A wide variety of test methods are employed in order to develop current ratings for connectors. Some of these methods come from standards that are recognized industry-wide, while others are unique to the manufacturer or user. These various test methods can produce different results for the same product. It is no wonder confusion sometimes results.

There are key factors that, when understood, can help in choosing the right power connector. All test methods used to rate current have similarities; however, there are variables in applying the test methods which explain differing results.

Current ratings are usually established by first developing a temperature rise curve. This curve plots temperature rise against increasing current levels. The curve is a reliable tool in understanding heat generation of the connector at various currents. When a defined failure is reached, the test ends. The highest current level achieved is usually listed as the current rating.

The temperature rise curve, and therefore the current rating, will change when certain key factors are varied.

These are:

- Where is the temperature sensing probe placed? If placed on the contact in the mating area (the hottest spot), the results will be quite different than if placed on the outside of the connector body.
- Are the contacts being tested and rated in free air or are they contained within the connector housing? Contacts will obviously be cooler in free air.
- Are all of the contacts in the connector under load? If only part of the contacts are under load, the temperature rise could be less.
- What is the defined failure? Does the test end when the temperature rise reaches 30°C, 40°C, or some other number? Does it end when the temperature rise plus ambient temperature equal the operating limit of the connector housing? The current rating will be fixed by the defined failure point.
- How were the test samples prepared? Were the samples energized through a P.C. board? How many layers? How large were the traces? What was the weight of the copper? Were the samples energized through wire? What size was the wire? How long was the wire? Was the sample tested in static or forced air conditions? All of these factors can affect cooling characteristics.

Clearly, a current rating value alone is not enough, and must be viewed in the context of the test used to develop the rating. When the test method is understood, evaluating and comparing power connectors for specific applications becomes much less of a mystery.

THE INFINITY HIGH POWER CONNECTOR SERIES
utilizes Positronic Industries'

LARGE SURFACE AREA CONTACT MATING SYSTEM

- Separates mechanical and electrical functions for superior performance
- “Closed Entry” design prevents damage to female contacts and will not allow misaligned or bent contacts to enter
- Precision machined from solid copper alloy
- Uniform insertion withdrawal forces through repeated mating cycles

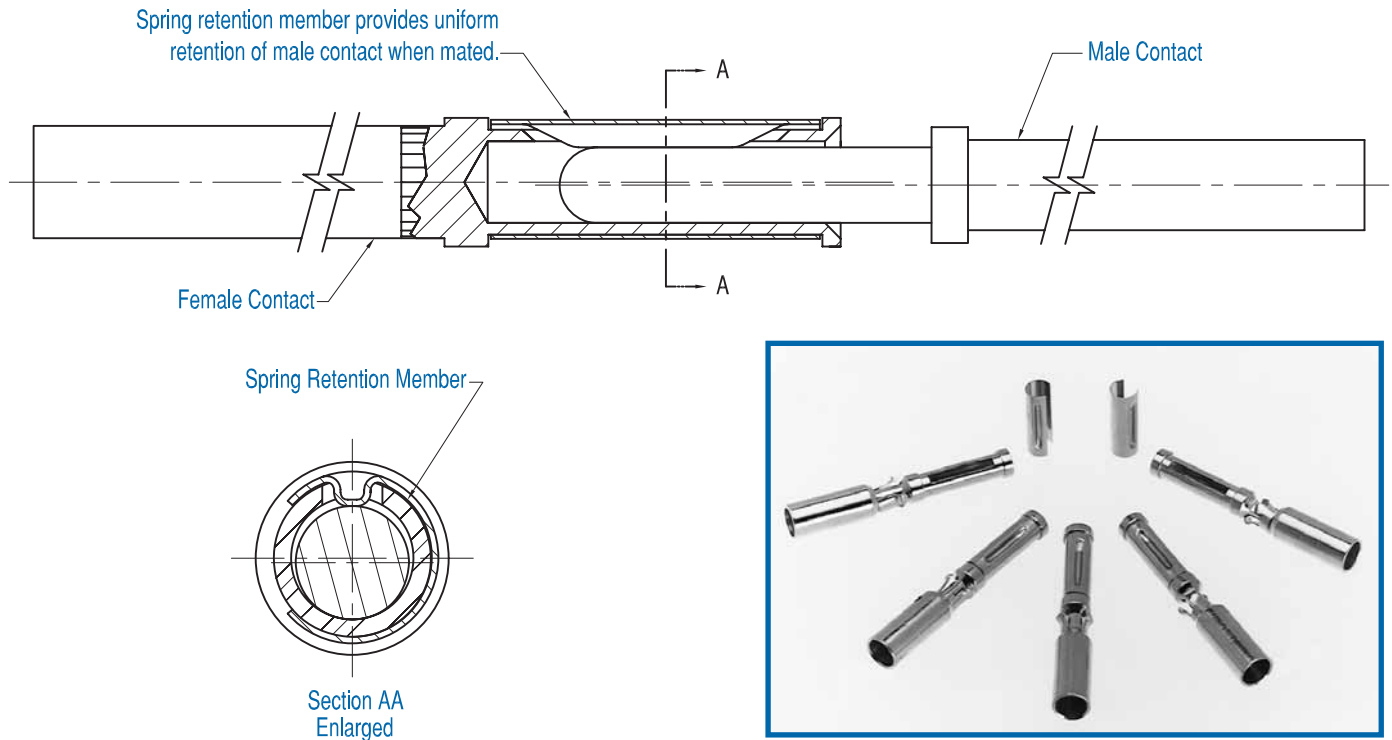

WHY IS THE L.S.A. SYSTEM SUPERIOR?

The primary function of connector contacts is electrical conductivity. Also, a mechanical function is required to provide normal force between male and female contacts.

In order to provide for proper mechanical characteristics, material that has good memory or “springiness” must be chosen. This will ensure contact normal force in a coupled condition and allow for repeated coupling and uncoupling.

Unfortunately, many materials that have good memory characteristics have low electrical conductivity. For instance, beryllium copper is a good choice for mechanical function; however, some beryllium copper

alloys are poor conductors and have relatively low conductivity ratings.

The conductivity path of many contact designs goes directly through materials that have been chosen based on mechanical need. If these materials have a low conductivity rating, increased contact resistance will result.

Positronic’s Large Surface Area Contact System separates the mechanical and electrical functions. A spring retention member provides normal forces, while the electrical conductivity path is through highly conductive contact material. See above detail.



Positronic Industries
connectpositronic.com

COMPLIANT PRESS-FIT TERMINATIONS

Infinity
High Power
Connector

POSITRONIC INDUSTRIES' BI-SPRING POWER PRESS-FIT TERMINATIONS

The Next Evolution In Compliant Technology. Fully Compliant, Fully Reliable.

Reliable, solderless connections from connectors to backplanes started with solid press-fit technology. Although these are still used today, concerns about board damage led to the use of compliant press-fit technology. This technology allows the connection to be made through compliance of the contact termination along with P.C. board hole deformation. Although risk of damaged P.C. boards and backplanes is lessened, damage can still

occur due to relatively high insertion and extraction forces.

The next step in press-fit technology is a highly reliable connection between the contact termination and backplane that is accomplished with reduced insertion and extraction forces. This eliminates risk of P.C. board and backplane damage. **This technology exists today with Positronic Industries' Bi-Spring Power Press-Fit Termination.**

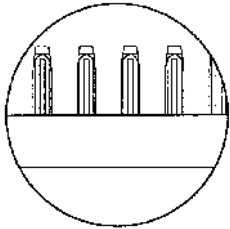

Bi-Spring Power Press-Fit
Compliant Terminations

- The relatively low insertion and extraction forces of Bi-Spring Power Press-Fit contacts do not produce stresses in P.C. boards and backplanes that can occur with higher insertion forces. These stresses can cause board warpage and hole damage. Average insertion and extraction forces of size 16 contacts are 22 N [5 lbs.] per contact. Average insertion and extraction forces of size 12 contacts are 133 N [30 lbs.] per contact. Average insertions forces of size 8 contact are 133 N [30 lbs.] per contact.
- Connector systems utilizing Bi-Spring terminations use mounting screws to secure the connector to the P.C. board or backplane. Stresses that occur during coupling, uncoupling or shock and vibration of systems are not transferred to the P.C. boards or backplanes through the press-fit connection. The electrical integrity of the connector to board interface is maintained; this is particularly important in power applications. Bellcore GR1217 details a preference for mounting hardware when using press-fit terminations.
- Size 16 Bi-Spring terminations are designed to meet the performance requirements and hole diameters as listed in the internationally recognized specification IEC60352-5.
- Lower insertion and extraction forces eliminate the need for expensive pressing equipment.

OMEGA SIGNAL LEVEL PRESS-FIT TERMINATIONS

Today's power supplies feature communication options with the host system. The power interface must have reliable signal level connections.

Positronic Industries' Omega Press-Fit terminations are the perfect solderless connection companion to Bi-Spring Power Press-Fit terminations.

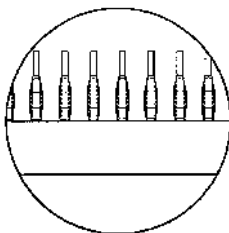

Omega Signal Level Press-Fit
Compliant Terminations

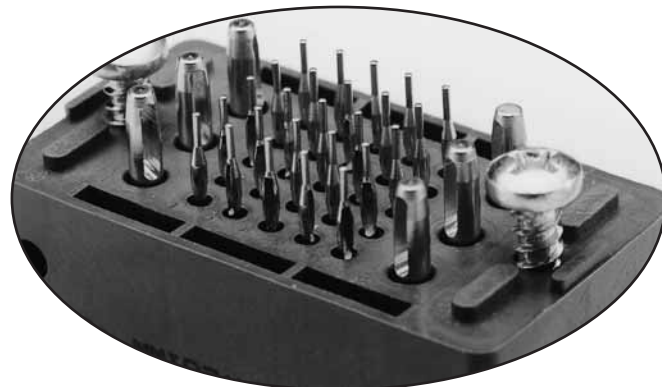

- ◆ **BLIND MATING SYSTEM** molded in guides allow for misalignment up to 4.19mm [0.165 inch] for MMIP series and 7.62 mm [0.300 inch] offset for MIP and IP series.
- ◆ **SEQUENTIAL MATING MALE AND FEMALE CONTACTS** may be specified to provide 3.00 mm [0.118 inch] nominal steps in mating length.

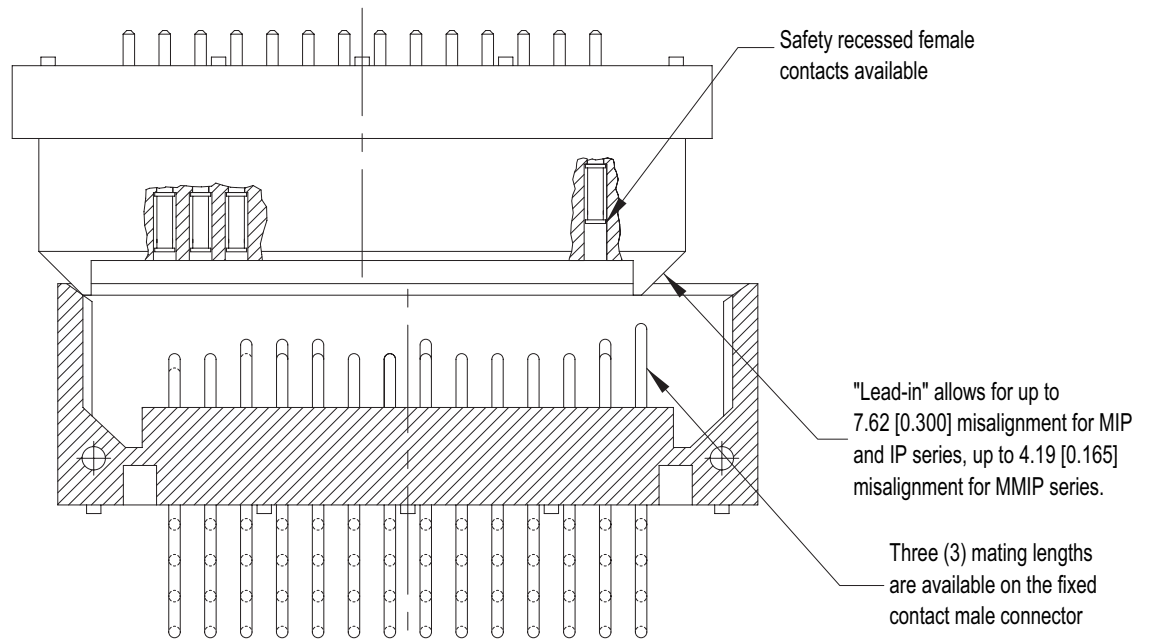

Consult Technical Sales for assistance when specifying **Sequential Mate Contacts**.

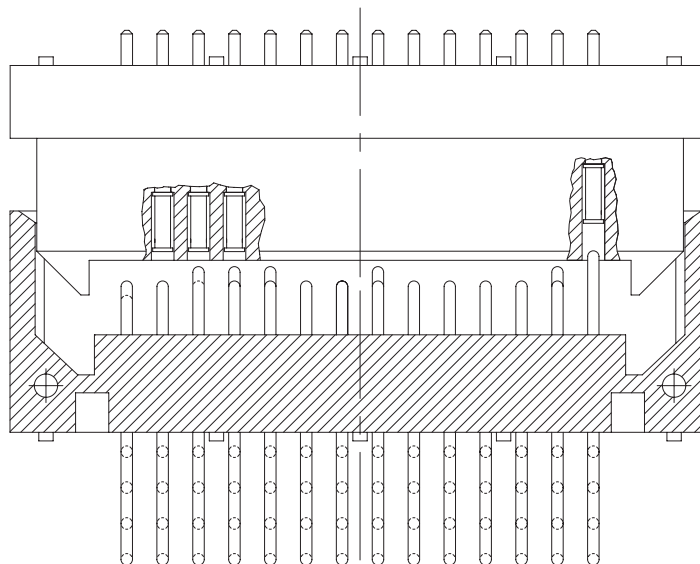



The Infinity High Power Connector design allows for the development of application specific contact arrangements in a timely manner and at a reasonable price. After reviewing the following basic information, contact Technical Sales with your current, voltage, and safety requirements. We look forward to working with you to develop a connector for your specific needs.

BASIC CONNECTOR DIMENSIONS

MALE CONNECTOR

FEMALE CONNECTOR

MMIP Series

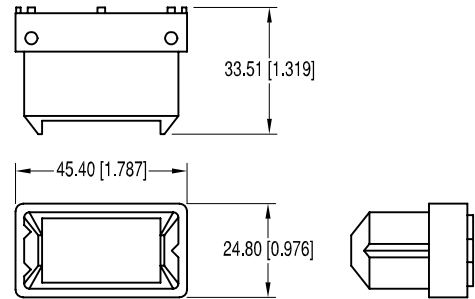
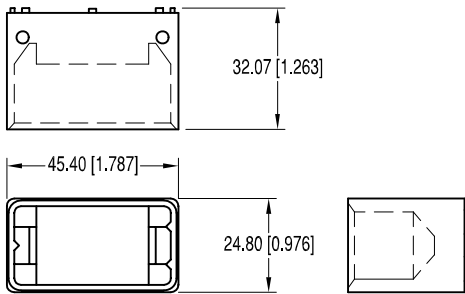

MMIP Series

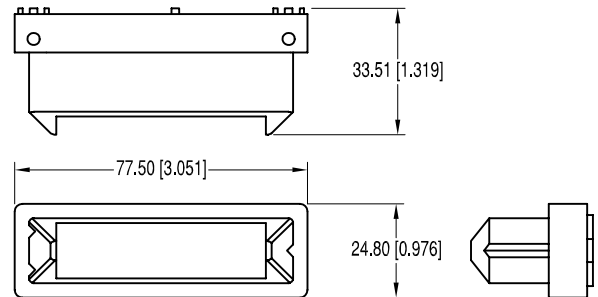
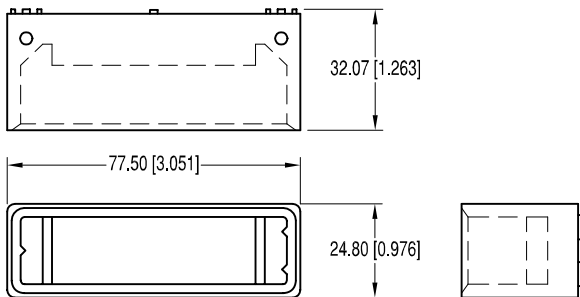

IP Series

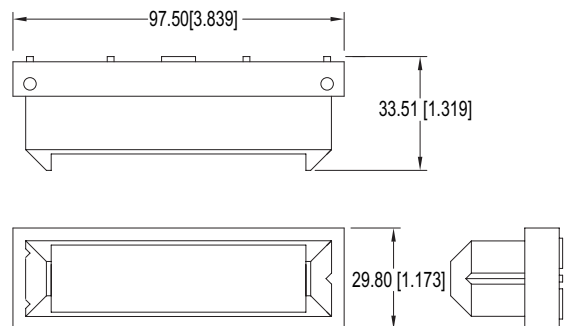
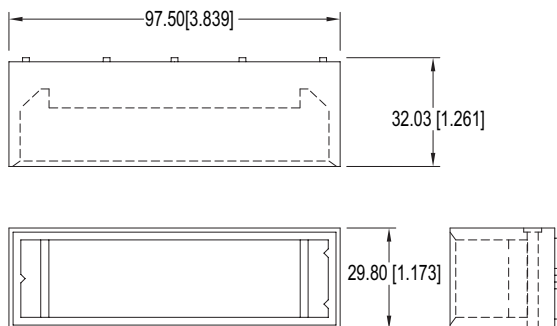

Four Contact Sizes to Choose From

A high performance size 8 contact rated at 100 Amps is available for use with 6 AWG wire.

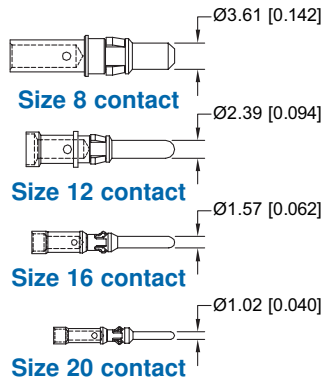

Contact sizes and termination types may be mixed within a single connector.

Many Termination Types Can Be Supplied

- Straight Solder or Press-Fit
- Right Angle (90°) Solder or Press-Fit
- Crimp Removable
- Removable Solder Cup
- Different Termination Types can be mixed within a single connector

Popular Options

- Sequential Mating
- Recessed Female Contacts
- Selective Loading

Let us know what your current, voltage and safety requirements are as well as contact termination and mounting needs. We look forward to developing a power connector for your specific application.

GENERAL PRODUCT INFORMATION

The Infinity Power Connector series was developed to supply the electronics industry a high power interface with features which allow the user flexibility in overcoming the design challenges created by the increasing power consumption of systems.

The availability of more computing capability in a given space, as well as reductions in the voltages that are required to drive modern electronic devices, facilitated a need for power interfaces with greater power density.

Along with higher power density, today's power interfaces are expected to provide features and options which simplify system designs. Much of the time, these must be packaged into a single connector and of course quality, reliability and value are a must. Infinity High Power Connectors use contacts which are machined from solid copper alloys and utilize Positronic Industries' Large Surface Area contact system. These features provide superior current carrying performance. A multitude of power contacts allow for efficient distribution of current in

multi-voltage centralized power applications. Contacts can also be paralleled together to meet high current requirements of single voltage distributed power applications. This, coupled with many outstanding features and options, makes the connector an excellent choice as the power interface for telecom, datacom, and computing platforms, as well as other power applications.





TECHNICAL CHARACTERISTICS

MATERIALS AND FINISHES:

| | |
|-----------------------------|---|
| Insulator: | Glass-filled polyester, UL 94V-0, blue color. |
| Contacts: | Precision-machined copper alloy with gold flash over nickel, or 0.76 microns [0.000030 inch] gold over nickel, or 1.27 microns [0.000050 inch] gold over nickel. Solder-coated terminations optional. |
| Mounting Screws: | Steel, zinc plated. |
| Push-on Fastener: | Spring-temper copper alloy, tin plated. |
| Float Mount Bushing: | Steel, zinc plated. |

ELECTRICAL CHARACTERISTICS:

| | |
|--|---|
| Contact Current Rating: | |
| Size 12 Contact: | 40 amperes, continuous. |
| Size 16 Contact: | 20 amperes, continuous. |
| Size 20 Contact: | 5 amperes. |
| Initial Contact Resistance; maximum: | |
| Size 12 Contact: | 0.001 ohms. |
| Size 16 Contact: | 0.0016 ohms. |
| Size 20 Contact: | 0.007 ohms. Per IEC 512-2, Test 2b. |
| Insulator Resistance: | 5 G ohms per IEC 512-2, Test 3a. |
| Voltage Proof: | 2000 V rms per IEC 512-2, Test 4a, Method C. |
| Hot Pluggable (50 Couplings per U.L. 1977, Paragraph 15): | |
| Size 12 Contact: | 250 VAC at 25 amperes. |
| Creepage Distances: | Consult Technical Sales for information about your specific connector choice. |
| Clearance Distance: | Consult Technical Sales for information about your specific connector choice. |
| Working Voltage: | Consult Technical Sales for information about your specific connector choice. |

MECHANICAL CHARACTERISTICS:

| | |
|---|--|
| Blind Mating System: | Molded in guides allow for misalignment up to 4.19 mm [0.165 inch] |
| Polarization: | Provided by connector body design. |
| Removable Contacts: | Insert contact in rear face of insulator; release from front face of insulator. Female contacts feature "Closed Entry" design. |
| Removable Contact Retention in Connector Body: | |
| Size 12 Contact: | 67N [15 lbs.] per IEC 512-8, Test 15a. |
| Size 16 Contact: | 67N [15 lbs.] per IEC 512-8, Test 15a. |
| Size 20 Contact: | 44N [10 lbs.] per IEC 512-8, Test 15a. |
| Fixed Contacts: | Printed board terminations, both straight and right angle (90°). Size 12 and 16 female contacts feature "Closed Entry" design. Size 20 female contacts feature "Rugged Open Entry" design. |
| Fixed Contact Retention in Connector Body: | 44N [10 lbs.], minimum. |
| Resistance to Solder Heat: | 260°C [500°F] for 10 seconds duration per IEC 512-6, Test 12e, 25-watt soldering iron. |
| Sequential Contact Mating System: | Two level and three level systems featured. Consult Technical Sales for application assistance with contact sequencing. |
| Safety "Recessed in Insulator" Contacts: | Size 16 female contacts may be recessed 5.00 mm [0.197 inch] below the face of the female connector insulator per safety requirements. Consult Technical Sales for ordering information. |
| Compliant Press-Fit Terminations: | Size 12, 16 and 20 contacts are available with Compliant Press-Fit Contact Terminations. Consult Technical Sales for electrical and mechanical characteristics. |
| Printed Board and Panel Mounting Holes: | Mounting holes provided in connector body for both printed board and panel mounting. Self-tapping screws or push-on fastener options are available. |
| Float Mount Shoulder Screw: | Provides up to 2.03 mm [0.080 inch] float. |
| Mechanical Operations: | |
| Systems 1, 2 & 7: | 200 couplings. |
| Systems 3, 4 & 5: | 250 couplings. |

CLIMATIC CHARACTERISTICS:

| | |
|-----------------------------|------------------|
| Working Temperature: | -55°C to +125°C. |
|-----------------------------|------------------|



For RoHS options
see page 16.

Recognized by various safety agencies.
Consult Technical Sales for updated list.

CONTACT VARIANTS

FACE VIEW OF MALE OR REAR VIEW OF FEMALE

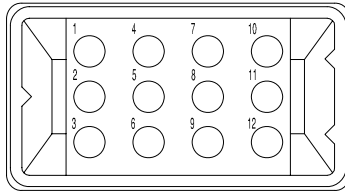

MMIP12W12 VARIANT
12 Size 12 Contacts

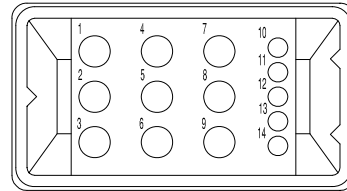

MMIP14W9 VARIANT
9 Size 12 and 5 Size 20 Contacts

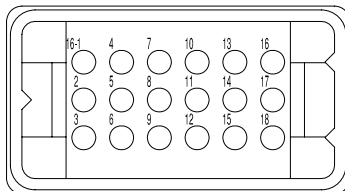

MMIP18 VARIANT
18 Size 16 Contacts

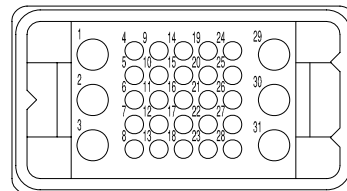

MMIP31W6 VARIANT
6 Size 12 and 25 Size 20 Contacts

Refer to pages 7 & 8 for
Application Specific Arrangements

MMIP SERIES

CONNECTOR MATING DIMENSIONS

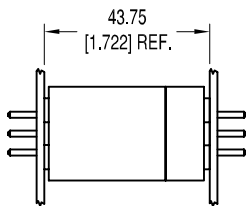

**Straight Board Mount or
Panel Mount Female to
Straight Board Mount or
Panel Mount Male**

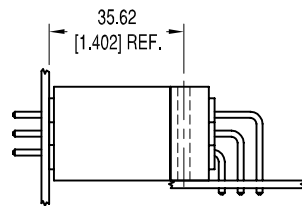

**Right Angle (90°) Board
Mount Female to
Straight Board Mount
or Panel Mount Male.**

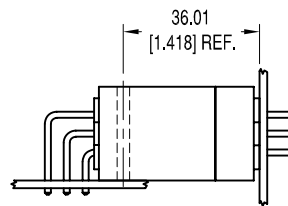

**Straight Board Mount
or Panel Mount Female
to Right Angle (90°)
Board Mount Male.**

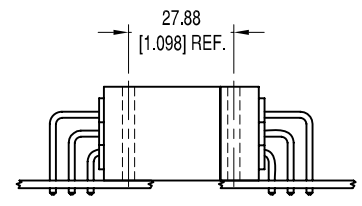

**Right Angle (90°)
Board Mount Female
to Right Angle (90°)
Board Mount Male.**



CONNECTOR OUTLINE DIMENSIONS FOR USE WITH CODE 0, 3, 32, 93, 4, 42, AND 63

MALE

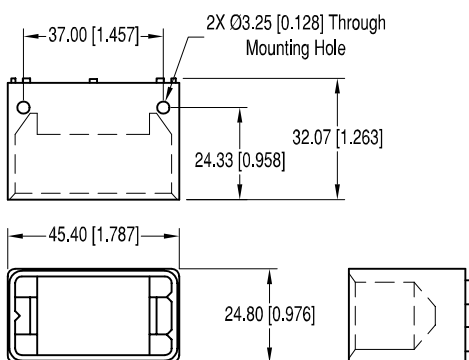

FEMALE

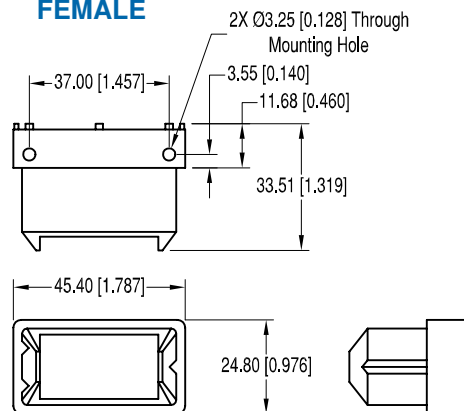

MMIP SERIES



CABLE CONNECTOR

FOR USE WITH SIZE 12, 16 AND 20 REMOVABLE CONTACTS
CODE 0

CONTACTS ARE NOT SUPPLIED WITH CONNECTOR AND MUST BE ORDERED SEPARATELY

MALE

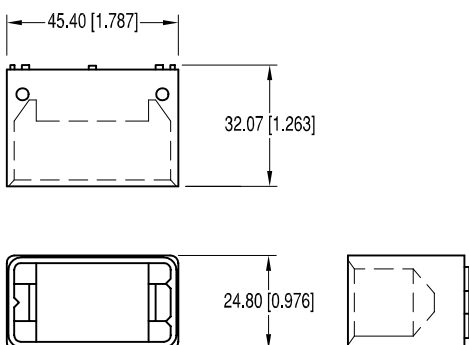

FEMALE

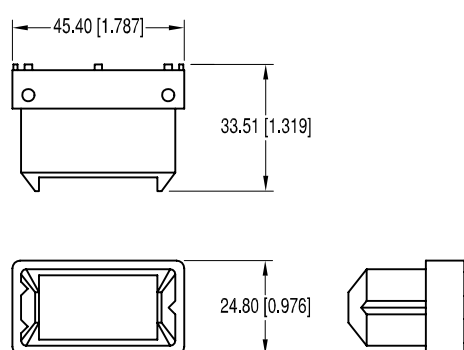

For information regarding size 12, 16 and 20 removable contacts, see Removable Contact section, pages 41-48.

| CODE | "A" LENGTH |
|------|--------------|
| 3 | 3.70 [0.146] |
| 32 | 9.58 [0.377] |

STRAIGHT SOLDER BOARD MOUNT CONNECTORS

CODE 3 AND CODE 32

MALE CONNECTOR SHOWN FOR REFERENCE ONLY

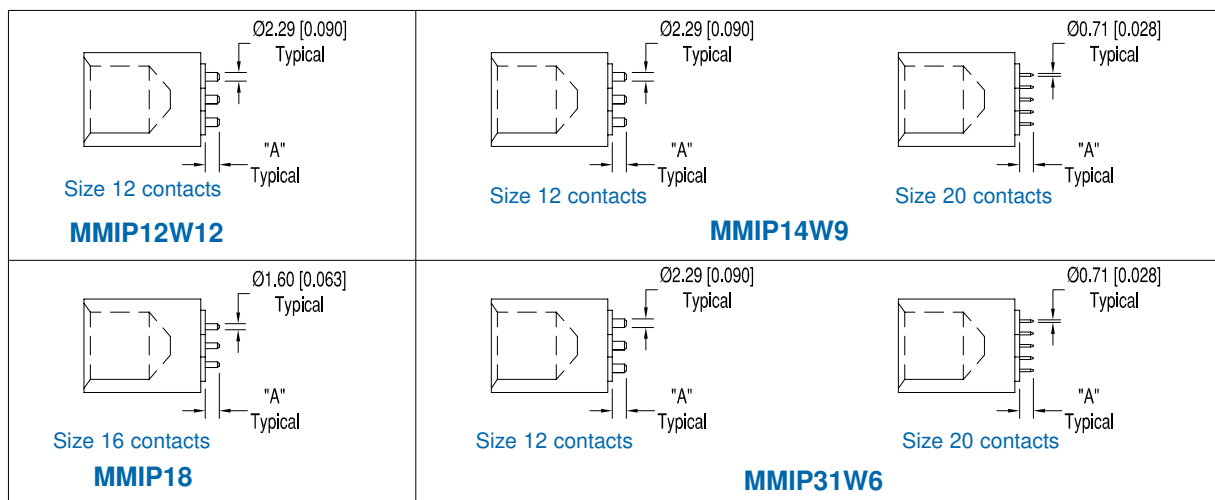

MMIP SERIES

STRAIGHT SOLDER CONTACT HOLE PATTERNS

HOLE PATTERN SHOWN IS FOR MALE CONNECTOR
USE MIRROR IMAGE FOR FEMALE CONNECTOR

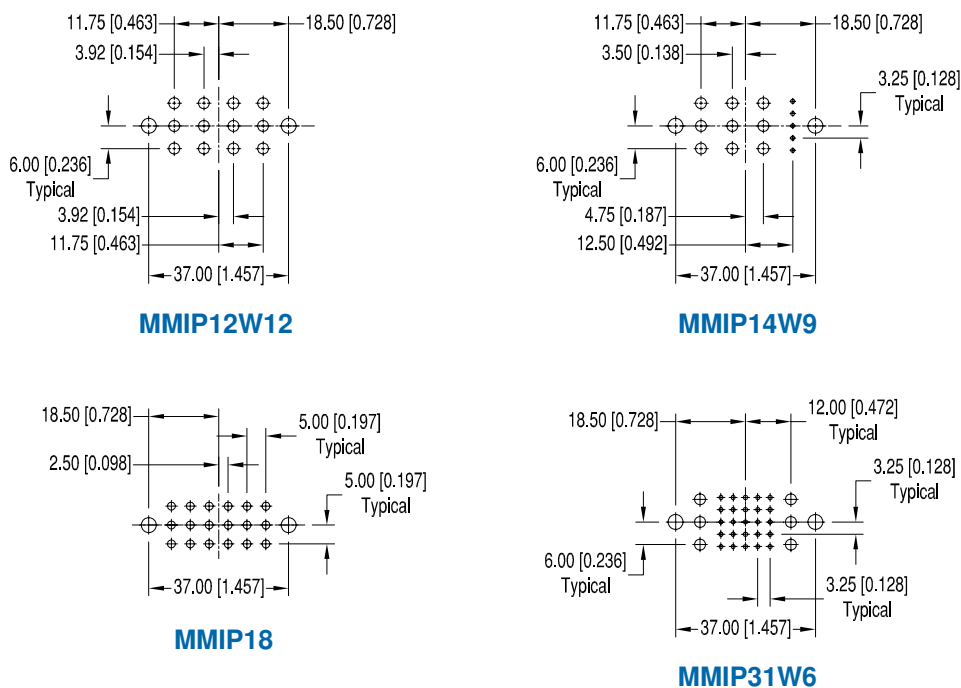

SUGGESTED PRINTED BOARD HOLE SIZES:

- Suggested $\text{Ø}1.14$ [0.045] holes for size 20 contact holes.
- Suggested $\text{Ø}2.11$ [0.083] holes for size 16 contact holes.
- Suggested $\text{Ø}2.90$ [0.114] holes for size 12 contact holes.
- Suggested $\text{Ø}3.96 \pm 0.08$ [0.156 \pm 0.003] holes for connector mounting holes.



STRAIGHT COMPLIANT PRESS-FIT CONNECTORS

CODE 93

MALE CONNECTOR SHOWN FOR REFERENCE ONLY

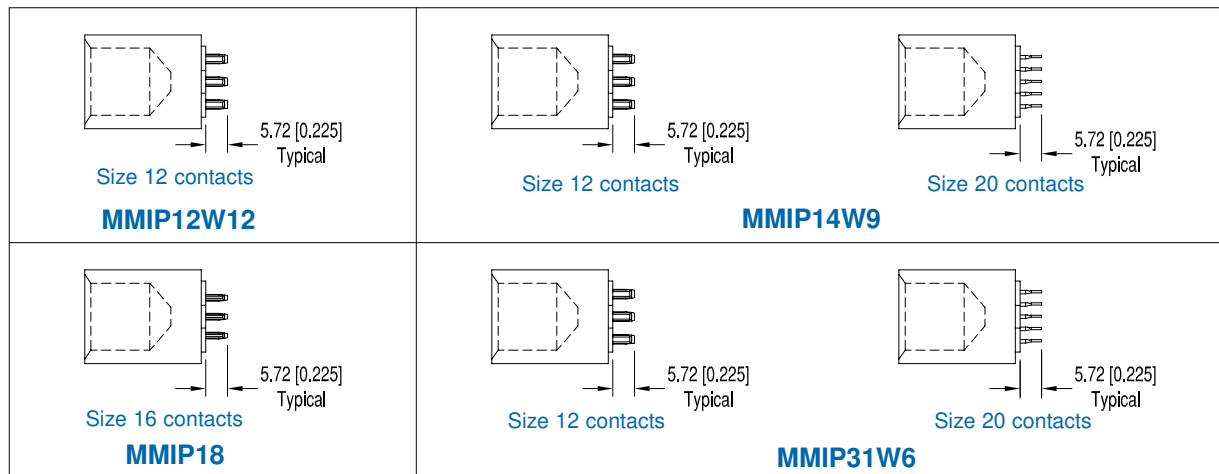

STRAIGHT COMPLIANT PRESS-FIT CONTACT HOLE PATTERNS

HOLE PATTERN SHOWN IS FOR MALE CONNECTOR
USE MIRROR IMAGE FOR FEMALE CONNECTOR

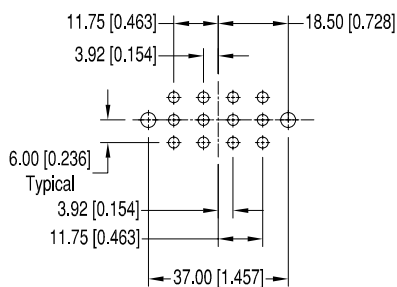

MMIP12W12

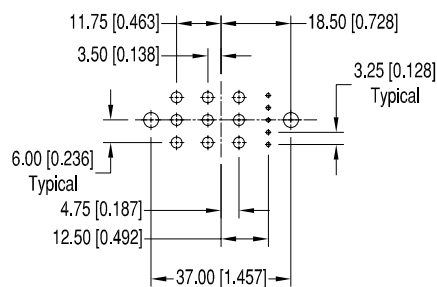

MMIP14W9

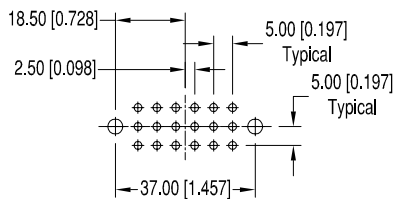

MMIP18

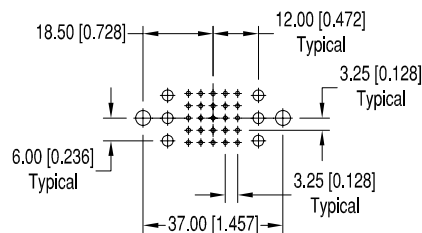

MMIP31W6

SUGGESTED PRINTED BOARD HOLE SIZES:

NOTE: See page 57 for suggested printed board drill hole sizes, recommended plating and finished hole sizes for compliant contact termination positions.

For press-fit connector installation tools, see pages 55-57.

For mounting screw options, see page 55.

| CODE | "A" LENGTH |
|------|--------------|
| 4 | 3.70 [0.146] |
| 42 | 9.58 [0.377] |

RIGHT ANGLE (90°) SOLDER BOARD MOUNT CONNECTORS

CODE 4 AND CODE 42

MALE CONNECTOR SHOWN FOR REFERENCE ONLY

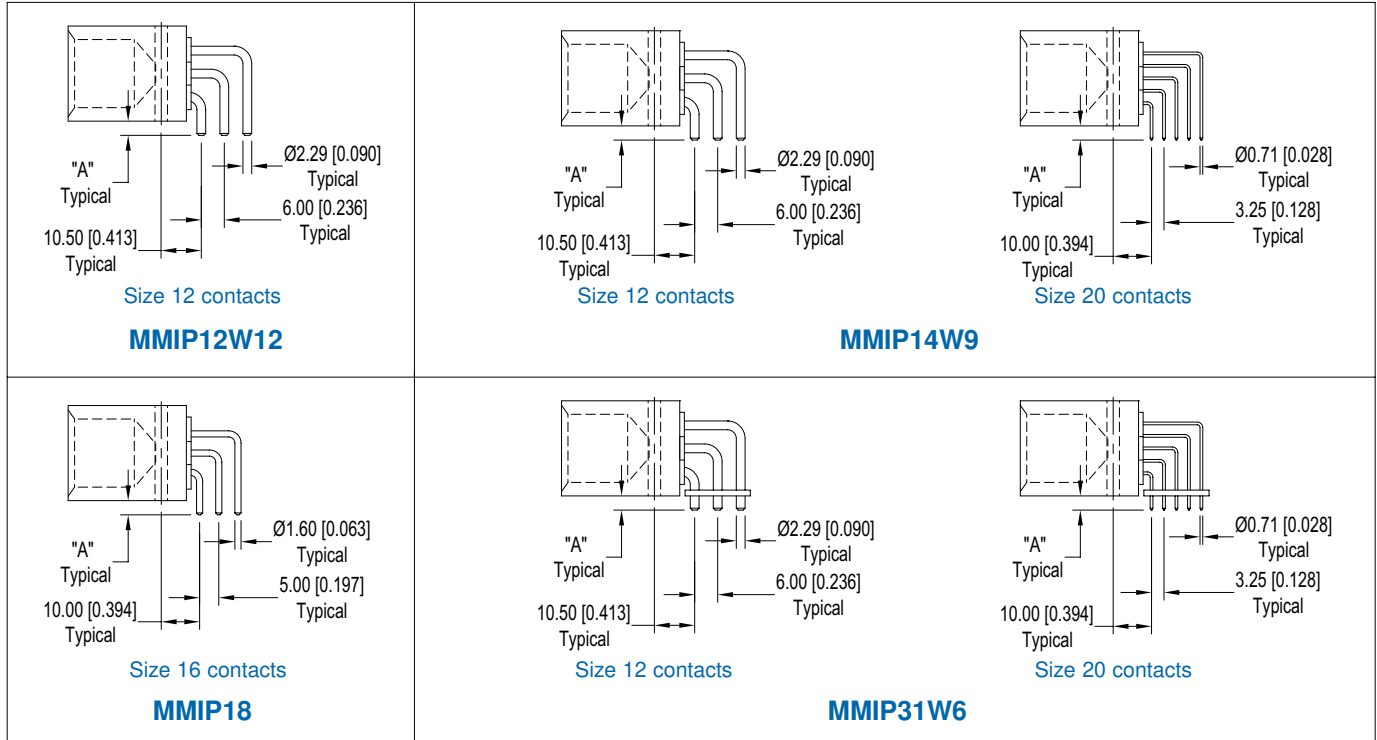

RIGHT ANGLE (90°) SOLDER CONTACT HOLE PATTERNS

HOLE PATTERN SHOWN IS FOR MALE CONNECTOR

USE MIRROR IMAGE FOR FEMALE CONNECTOR

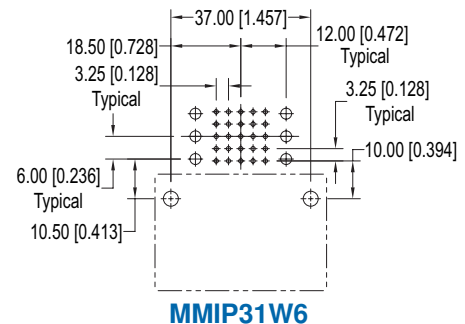
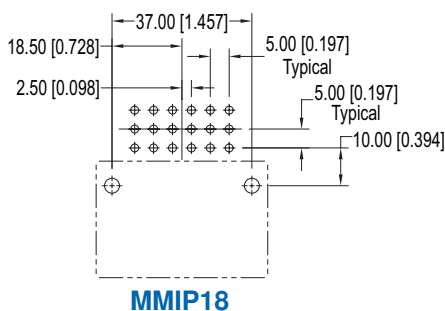
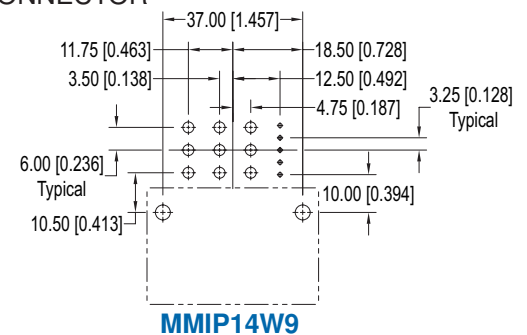
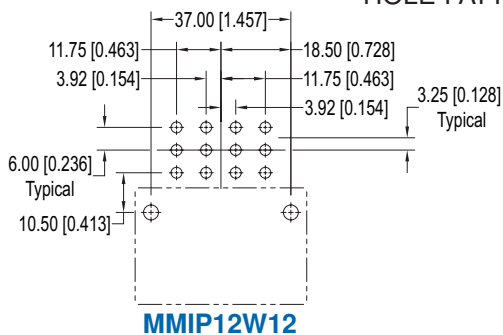

SUGGESTED PRINTED BOARD HOLE SIZES:

Suggested $\varnothing 1.14$ [0.045] holes for size 20 contact holes.
Suggested $\varnothing 2.11$ [0.083] holes for size 16 contact holes.
Suggested $\varnothing 2.90$ [0.114] holes for size 12 contact holes.
Suggested $\varnothing 3.96 \pm 0.08$ [0.156 \pm 0.003] holes for connector mounting holes.



RIGHT ANGLE (90°) COMPLIANT PRESS-FIT BOARD MOUNT CONNECTORS CODE 63 MALE AND FEMALE

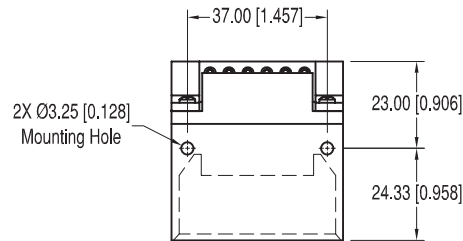

MALE

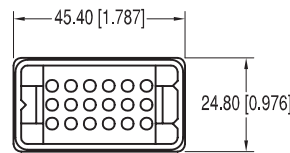

MMIP18

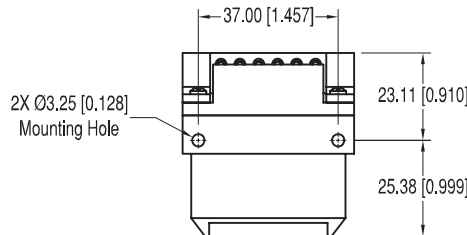
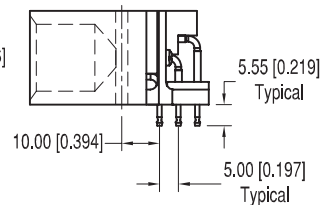

FEMALE

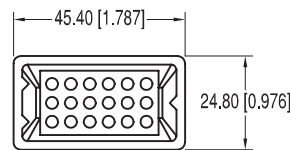

MMIP18

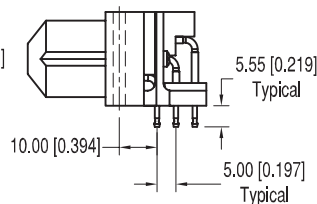

RIGHT ANGLE (90°) COMPLIANT PRESS-FIT CONTACT HOLE PATTERN MALE AND FEMALE

SUGGESTED PRINTED BOARD HOLE SIZES:

NOTE: See page 57 for suggested printed board drill hole sizes, recommended plating and finished hole sizes for compliant contact termination positions.

For press-fit connector installation tools, see pages 55-57.

For mounting screw options, see page 55.

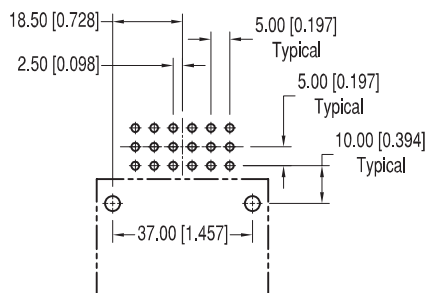

MMIP18

ORDERING INFORMATION - CODE NUMBERING SYSTEM

Specify Complete Connector By Selecting An Option From Step 1 Through 7

| STEP | 1 | 2 | 3 | 4 | 5 | 6 | 7 | 8 | 9 |
|---------|------|-------|---|----|---|---|----|-----|---|
| EXAMPLE | MMIP | 12W12 | F | 32 | 0 | 0 | A1 | /AA | — |

STEP 1 - BASIC SERIES

MMIP - Mini-Mini-Infinity

STEP 2 - CONNECTOR VARIANTS

- 12W12- 12 size 12 contacts
- 14W9 - 9 size 12 and 5 size 20 contacts
- 18 - 18 size 16 contacts
- 31W6 - 6 size 12 and 25 size 20 contacts

STEP 3 - CONNECTOR GENDER

- M - Male
- F - Female

STEP 4 - CONTACT TERMINATION TYPE

- 0 - Order contacts separately for cable connectors for connection systems 2, 4 and 5. See pages 41-48.
- 3 - Solder, Straight Printed Board Mount with 3.70 [0.146] tail extension for connection systems 1 and 4.
- 32- Solder, Straight Printed Board Mount with 9.58 [0.377] tail extension for connection systems 1 and 4.
- 4 - Solder, Right Angle (90°) Printed Board Mount with 3.70 [0.146] tail extension for connection systems 1, 2, 3 and 7.
- 42- Solder, Right Angle (90°) Printed Board Mount with 9.58 [0.377] tail extension for connection systems 1, 2, 3 and 7.
- 63 - Press-Fit, Compliant Termination Right Angle (90°) Printed Board Mount, for use with board thicknesses of 2.29 to 4.45 [0.090 to 0.175]. With cross bar. Connection systems 1, 2, 3 and 7. Available on connector variant 18 only.
- 93 - Press-Fit, Compliant Termination Straight Printed Board Mount for use with board thicknesses of 2.29 to 4.45 [0.090 to 0.175]. Connection systems 1 and 4.

STEP 5 - MOUNTING STYLE

- 0 - None, mounting screws supplied with board mount connector.
- N - Push-on fasteners supplied installed on board mount connector. Not recommended for code 63 and 93.

STEP 6 - PANEL MOUNT

- 0 - None.
- 82 - Panel Mount 1.52 [0.060] panel thickness
- 83 - Panel Mount 2.28 [0.090] panel thickness

***Hot Plug Note:** If UL approval is required for a Hot Plug connector, HP must be added to the part number. This is to be prior to any special plating or MOS requirements.

Example part numbers:

MMIP12W12M300A1-HP
MIP31W6M400A1-HP-294.0

STEP 9 - SPECIAL OPTIONS

CONTACT TECHNICAL SALES FOR SPECIAL OPTIONS

- * Sequential Mating
- Recessed Female Contacts
- Customer Specified Contact Arrangement
- Hot Plug (see below*)
- Other Customer Requirements

STEP 8 - ENVIRONMENTAL COMPLIANCE OPTIONS

/AA - Compliant per EU Directive 2002/95/EC (RoHS)



NOTE: If compliance to environmental legislation is not required, this step will not be used. Example: MMIP12W12F3200A1

STEP 7 - CONTACT PLATING

- 0 - Crimp contacts ordered separately. See pages 41-48.
- A1 - Gold flash over nickel on mating end and termination end.
- A2 - Gold flash over nickel on mating end and 5.00μ [0.00020 inch] tin-lead solder coat on termination end. Not available with code 63 and 93 in Step 4.
- C1 - 0.76μ [0.000030 inch] gold over nickel on mating end and termination end.
- C2 - 0.76μ [0.000030 inch] gold over nickel on mating end and 5.00μ [0.00020 inch] tin-lead solder coat on termination end. Not available with code types 63 and 93 in Step 4.
- D1 - 1.27μ [0.000050 inch] gold over nickel on mating end and termination end.
- D2 - 1.27μ [0.000050 inch] gold over nickel on mating end and 5.00μ [0.00020 inch] tin-lead solder coat on termination end. Not available with code types 63 and 93 in Step 4.

NOTE: Once you have made a connector selection, contact Technical Sales if you would like to receive a drawing in DXF, PDF format or a 3-dimensional IGES file.

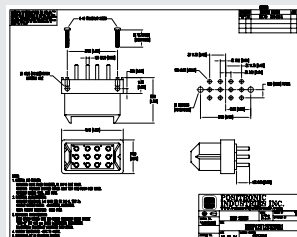

SK Drawing

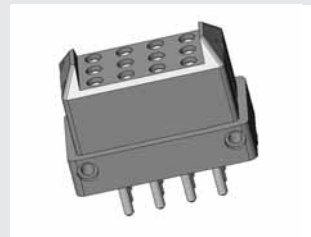

3-dimensional model



TECHNICAL CHARACTERISTICS

MATERIALS AND FINISHES:

| | |
|-----------------------------|---|
| Insulator: | Glass-filled polyester, UL 94V-0, blue color. |
| Contacts: | Precision-machined copper alloy with gold flash over nickel, or 0.76 microns [0.000030 inch] gold over nickel, or 1.27 microns [0.000050 inch] gold over nickel. Solder-coated terminations optional. |
| Mounting Screws: | Steel, zinc plated. |
| Push-on Fastener: | Spring-temper copper alloy, tin plated. |
| Float Mount Bushing: | Steel, zinc plated. |

ELECTRICAL CHARACTERISTICS:

| | |
|--|---|
| Contact Current Rating: | |
| Size 8 Contact: | 60 amperes, continuous. |
| Size 12 Contact: | 40 amperes, continuous. |
| Size 16 Contact: | 20 amperes, continuous. |
| Size 20 Contact: | 5 amperes. |
| | Temperature Rise Curves per IEC 512-3, Test 5a. See page 19 of this catalog for performance curves. |
| Initial Contact Resistance; maximum: | |
| Size 8 Contact: | 0.0005 ohms. |
| Size 12 Contact: | 0.001 ohms. |
| Size 16 Contact: | 0.0016 ohms. |
| Size 20 Contact: | 0.007 ohms. |
| | Per IEC 512-2, Test 2b. |
| Insulator Resistance: | 5 G ohms per IEC 512-2, Test 3a. |
| Voltage Proof: | 2000 V rms per IEC 512-2, Test 4a, Method C. |
| Hot Pluggable (50 Couplings per U.L. 1977, Paragraph 15): | |
| Size 8 Contact: | 250 VAC at 25 amperes. |
| Size 12 Contact: | 250 VAC at 25 amperes. |
| Creepage Distances: | Consult Technical Sales for information about your specific connector choice. |
| Clearance Distance: | Consult Technical Sales for information about your specific connector choice. |
| Working Voltage: | Consult Technical Sales for information about your specific connector choice. |

MECHANICAL CHARACTERISTICS:

| | |
|---|---|
| Blind Mating System: | Molded in guides allow for misalignment up to 7.62 mm [0.300 inch] |
| Polarization: | Provided by connector body design. |
| Removable Contacts: | Insert contact in rear face of insulator; release from front face of insulator. Female contacts feature "Closed Entry" design. |
| Removable Contact Retention in Connector Body: | |
| Size 8 Contact: | 67N [15 lbs.] per IEC 512-8, Test 15a. |
| Size 12 Contact: | 67N [15 lbs.] per IEC 512-8, Test 15a. |
| Size 16 Contact: | 67N [15 lbs.] per IEC 512-8, Test 15a. |
| Size 20 Contact: | 44N [10 lbs.] per IEC 512-8, Test 15a. |
| Fixed Contacts: | Printed board terminations, both straight and right angle (90°). Size 8, 12 and 16 female contacts feature "Closed Entry" design. Size 20 female contacts feature "Rugged Open Entry" design. |
| Fixed Contact Retention in Connector Body: | 44N [10 lbs.], minimum. |
| Resistance to Solder Heat: | 260°C [500°F] for 10 seconds duration per IEC 512-6, Test 12e, 25-watt soldering iron. |
| Sequential Contact Mating System: | Two level and three level systems featured. Consult Technical Sales for application assistance with contact sequencing. |
| Safety "Recessed in Insulator" Contacts: | Size 16 female contacts may be recessed 5.00 mm [0.197 inch] below the face of the female connector insulator per safety requirements. Consult Technical Sales for ordering information. |
| Compliant Press-Fit Terminations: | Size 8, 12, 16 and 20 contacts are available with Compliant Press-Fit Contact Terminations. Consult Technical Sales for electrical and mechanical characteristics. |
| Printed Board and Panel Mounting Holes: | Mounting holes provided in connector body for both printed board and panel mounting. Self-tapping screws or push-on fastener options are available. |
| Float Mount Shoulder Screw: | Provides up to 2.03 mm [0.080 inch] float. |
| Mechanical Operations: | |
| Systems 1, 2 & 7: | 200 couplings. |
| Systems 3, 4 & 5: | 250 couplings. |

CLIMATIC CHARACTERISTICS:

| | |
|-----------------------------|------------------|
| Working Temperature: | -55°C to +125°C. |
|-----------------------------|------------------|

Recognized by various safety agencies.
Consult Technical Sales for updated list.



For RoHS options
see page 28.

CONNECTOR VARIANTS

FACE VIEW OF MALE OR REAR VIEW OF FEMALE

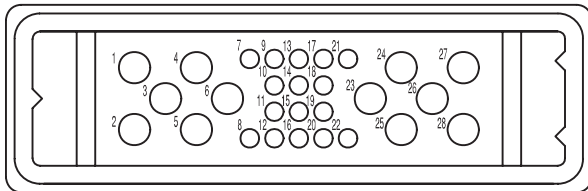

MIP28W12 VARIANT
12 Size 12 and 16 Size 20 Contacts

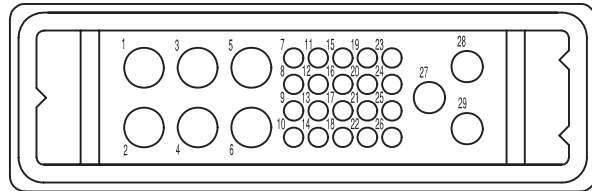

MIP29W9 VARIANT
6 Size 8, 3 Size 12, 20 Size 20 Contacts

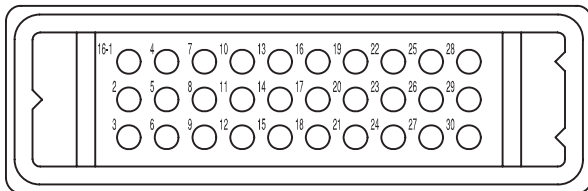

MIP30 VARIANT
30 Size 16 Contacts

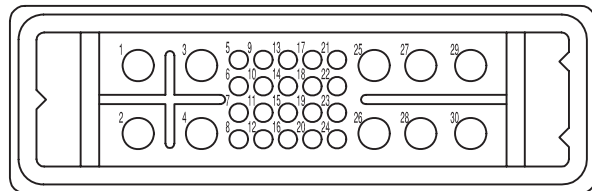

MIP30WA10 VARIANT
10 Size 12 and 20 Size 20 Contacts

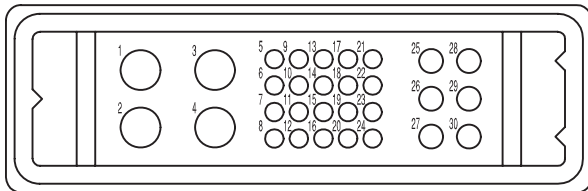

MIP30WB10 VARIANT
4 Size 8, 6 Size 16, 20 Size 20 Contacts

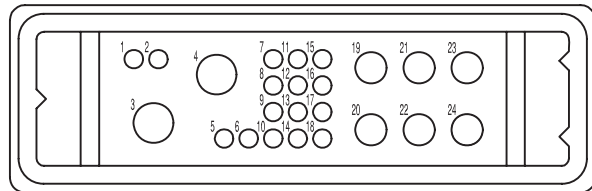

MIP24W8 VARIANT
2 Size 8
(See page 46 for high current or pages 45-48 for standard)
Size 12, 16 Size 20 Contacts
ONLY AVAILABLE FOR USE WITH CRIMP CONTACTS.

Refer to pages 7 & 8 for
Application Specific Arrangements

MIP SERIES



TEMPERATURE RISE CURVES AND CONNECTOR MATING DIMENSIONS

CONNECTOR TEMPERATURE RISE CURVES

Tested per IEC Publication 512-3, Test 5a

SIZE 16 CONTACTS

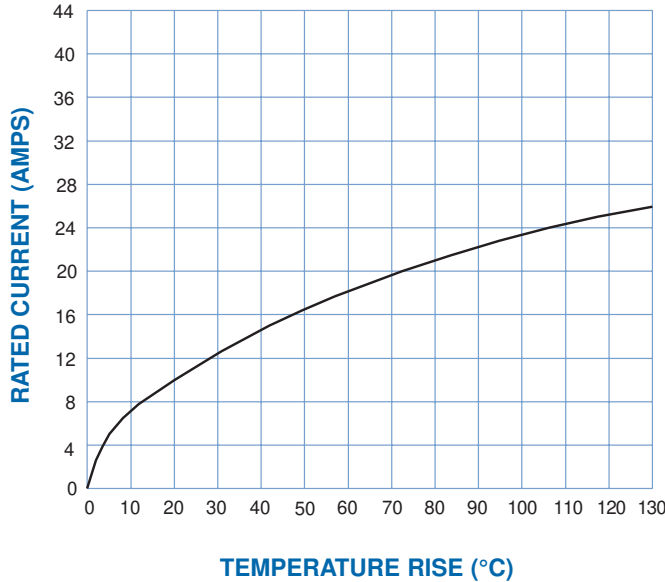

SIZE 12 CONTACTS

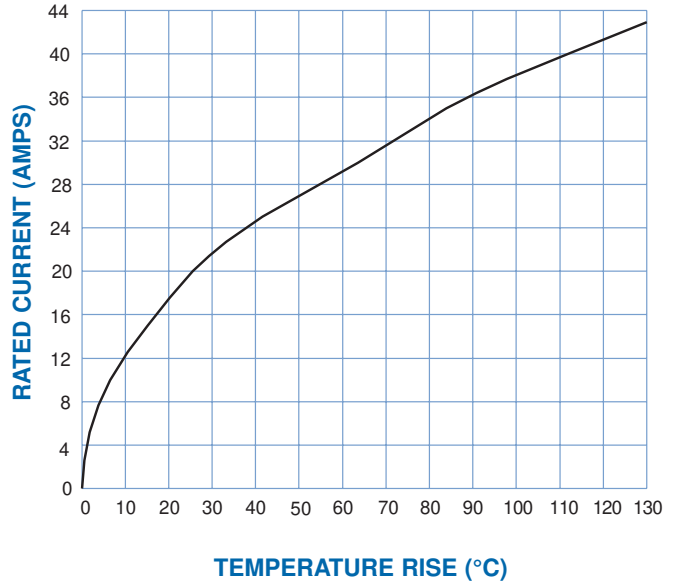

Above curve developed using MIP30M0000 and MIP30F0000 connectors with MC112N and FC112N2 contacts and 12 AWG wire. All contacts under load.

Above curve developed using MIP30WA10M0000 and MIP30WA10F0000 connectors and MC612N with FC612N2 contacts and 12 AWG wire. All contacts under load. Size 20 contact positions not filled and tested.

NOTE:

- 1) These temperature rise curves were developed using standard contact materials. High conductivity contact materials are available. These alternate materials allow for more favorable current carrying performance; consult Technical Sales for details.
- 2) Consult Technical Sales for Electrical and Mechanical characteristics of press-fit terminations.

CONNECTOR MATING DIMENSIONS

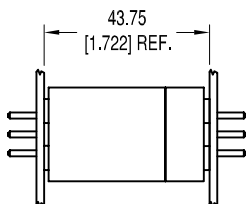

Straight Board Mount or Panel Mount Female to Straight Board Mount or Panel Mount Male.

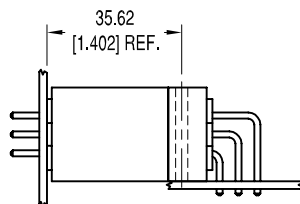

Right Angle (90°) Board Mount Female to Straight Board Mount or Panel Mount Male.

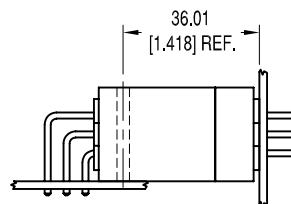

Straight Board Mount or Panel Mount Female to Right Angle (90°) Board Mount Male.

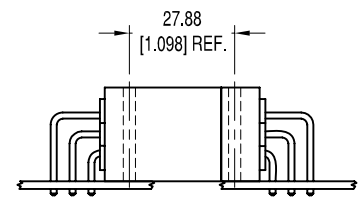

Right Angle (90°) Board Mount Female to Right Angle (90°) Board Mount Male.

CONNECTOR OUTLINE DIMENSIONS FOR USE WITH CODE 0, 3, 32, 93, 4, 42, AND 63

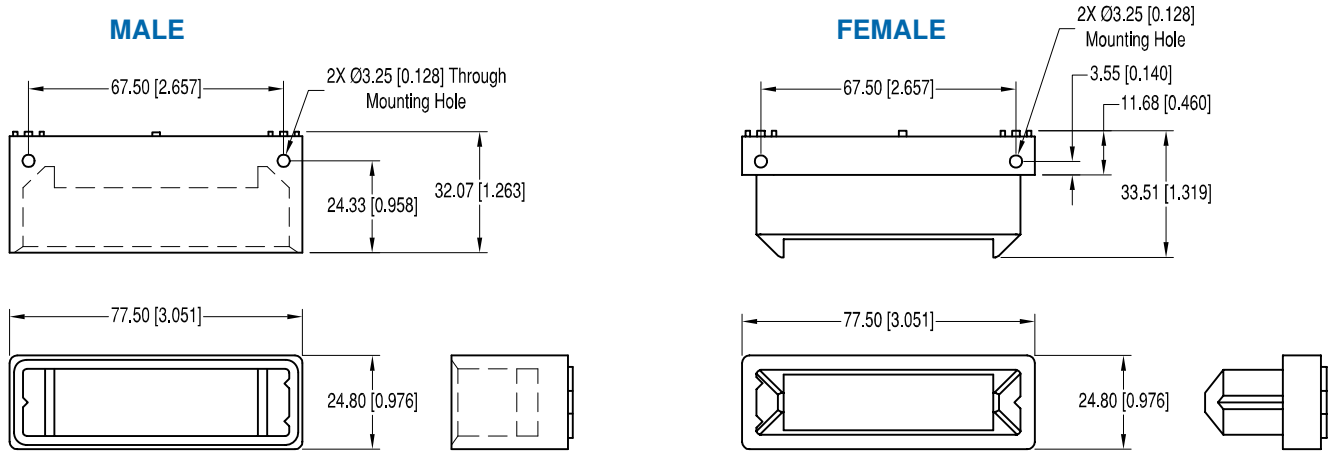

CABLE CONNECTOR

FOR USE WITH SIZE 8, 12, 16 AND 20 REMOVABLE CONTACTS
CODE 0

CONTACTS ARE NOT SUPPLIED WITH CONNECTOR AND MUST BE ORDERED SEPARATELY

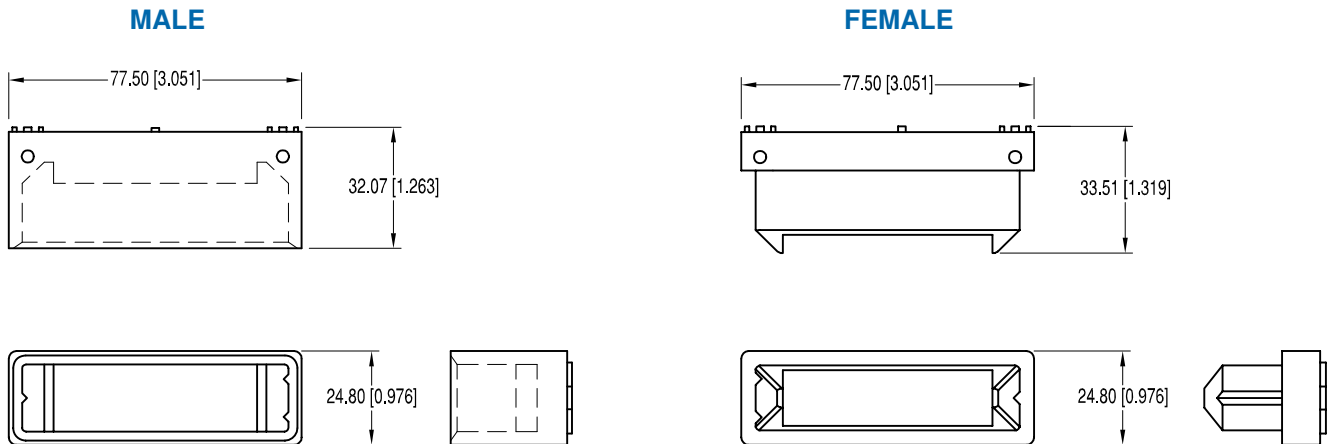

For information regarding size 8, 12, 16 and 20 removable contacts, see Removable Contact section, pages 41-48.



STRAIGHT SOLDER BOARD MOUNT CONNECTORS

CODE 3 AND CODE 32

MALE CONNECTOR SHOWN FOR REFERENCE ONLY

| CODE | "A" LENGTH |
|------|--------------|
| 3 | 3.70 [0.146] |
| 32 | 9.58 [0.377] |

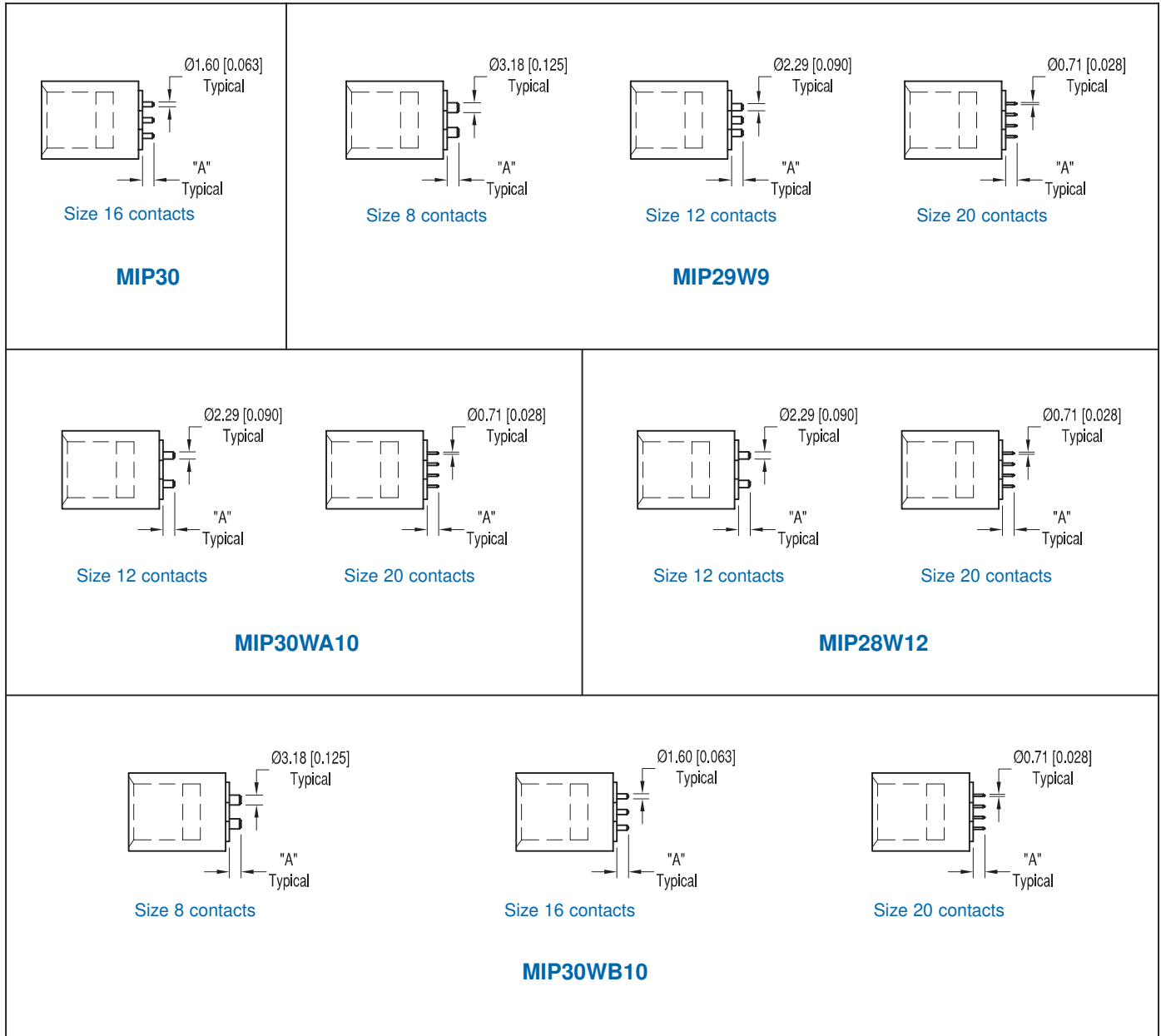

MIP SERIES

STRAIGHT SOLDER CONTACT HOLE PATTERNS

HOLE PATTERN SHOWN IS FOR MALE CONNECTOR
USE MIRROR IMAGE FOR FEMALE CONNECTOR

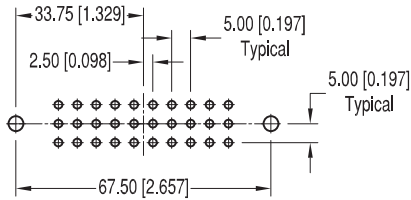

MIP30

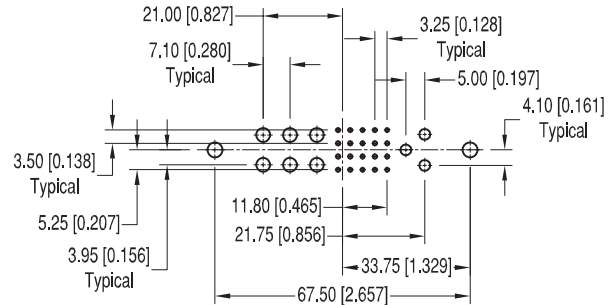

MIP29W9

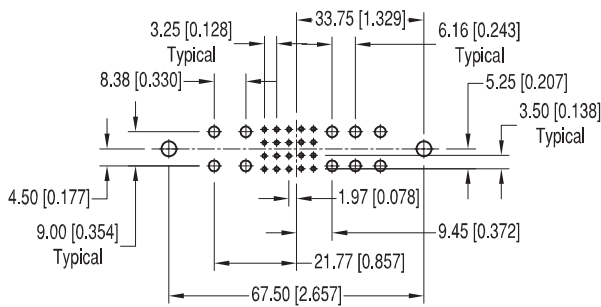

MIP30WA10

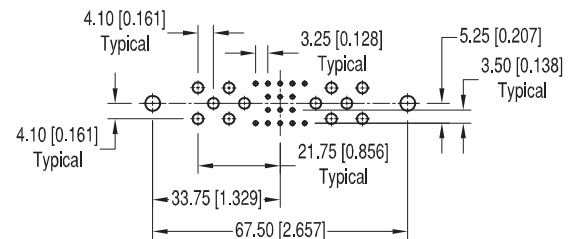

MIP28W12

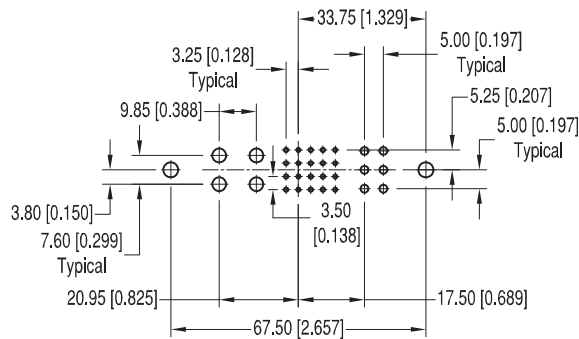

MIP30WB10

SUGGESTED PRINTED BOARD HOLE SIZES:

- Suggested $\phi 1.14$ [0.045] holes for size 20 straight contact holes.
- Suggested $\phi 2.11$ [0.083] holes for size 16 straight contact holes.
- Suggested $\phi 2.90$ [0.114] holes for size 12 straight contact holes.
- Suggested $\phi 3.68$ [0.145] holes for size 8 straight contact holes.
- Suggested $\phi 3.96 \pm 0.08$ [0.156 \pm 0.003] holes for connector mounting holes.



STRAIGHT COMPLIANT PRESS-FIT CONNECTORS CODE 93

MALE CONNECTOR SHOWN FOR REFERENCE ONLY

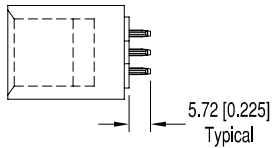

Size 16 contacts

MIP30

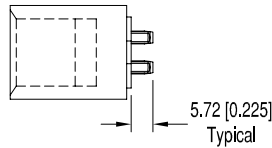

Size 8 contacts

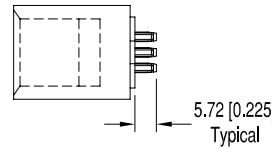

Size 12 contacts

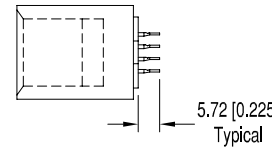

Size 20 contacts

MIP29W9

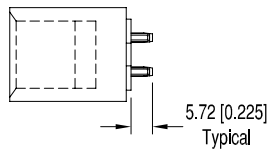

Size 12 contacts

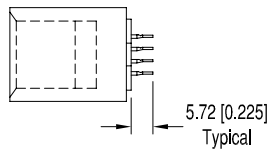

Size 20 contacts

MIP30WA10

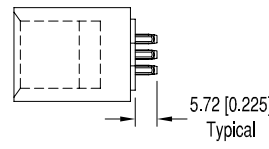

Size 12 contacts

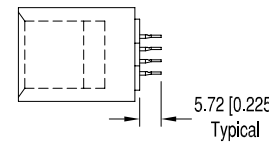

Size 20 contacts

MIP28W12

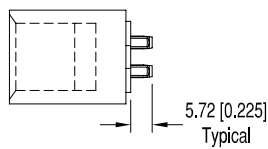

Size 8 contacts

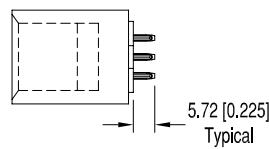

Size 16 contacts

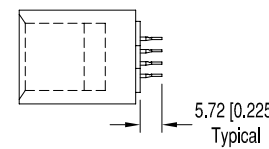

Size 20 contacts

MIP30WB10

STRAIGHT COMPLIANT PRESS-FIT CONTACT HOLE PATTERNS

HOLE PATTERN SHOWN IS FOR MALE CONNECTOR; USE MIRROR IMAGE FOR FEMALE CONNECTOR

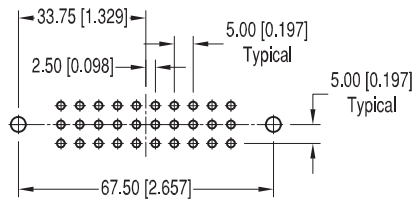

MIP30

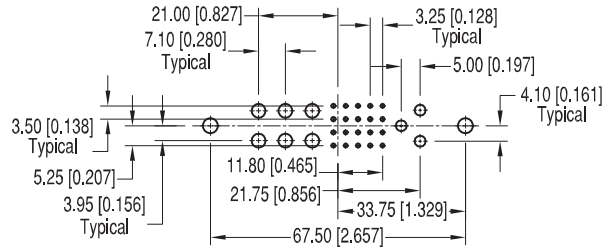

MIP29W9

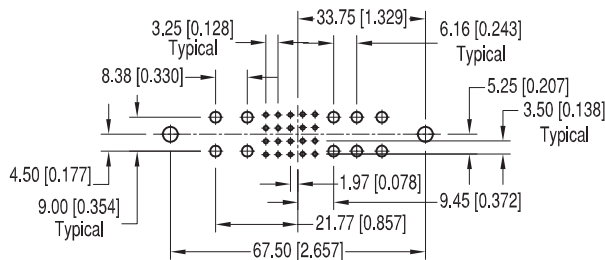

MIP30WA10

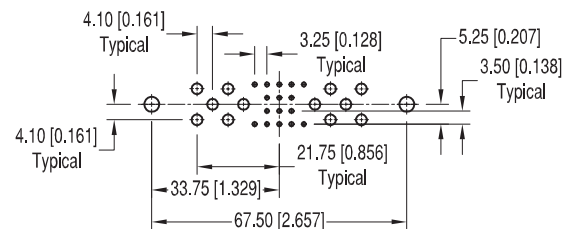

MIP28W12

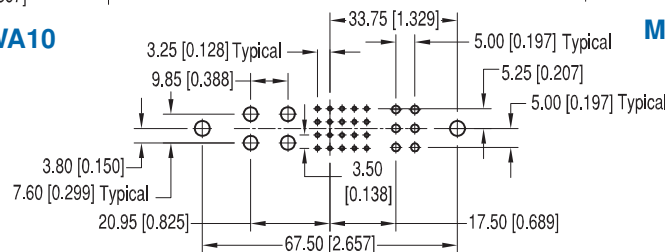

MIP30WB10

SUGGESTED PRINTED BOARD HOLE SIZES:

NOTE: See page 57 for suggested printed board drill hole sizes, recommended plating and finished hole sizes for compliant contact termination positions.

For press-fit connector installation tools, see pages 55-57.

For mounting screw options, see page 55.



RIGHT ANGLE (90°) SOLDER BOARD MOUNT CONNECTORS

CODE 4 AND CODE 42

MALE CONNECTOR SHOWN FOR REFERENCE ONLY

| CODE | "A" LENGTH |
|------|--------------|
| 4 | 3.70 [0.146] |
| 42 | 9.58 [0.377] |

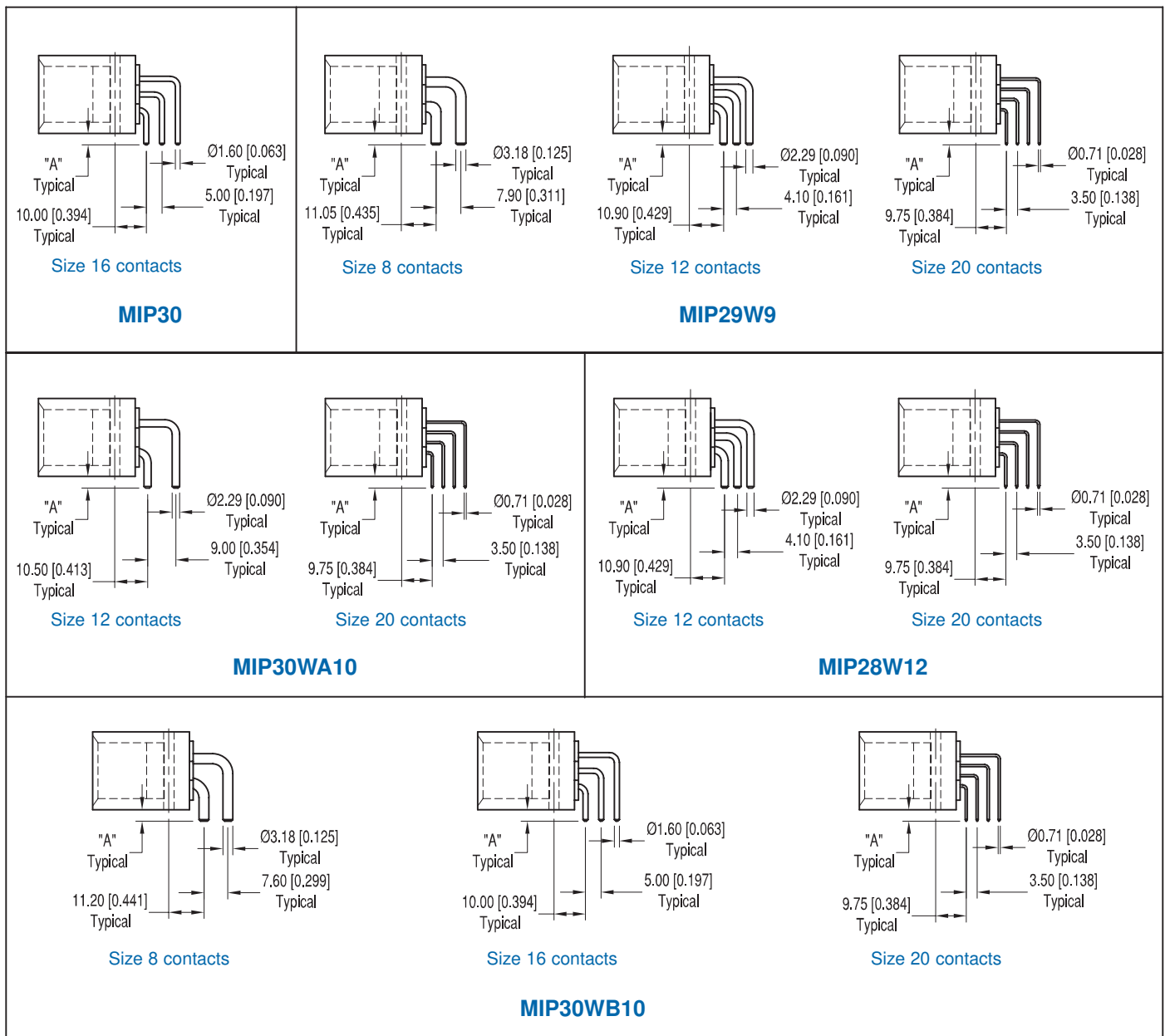

MIP SERIES

RIGHT ANGLE (90°) SOLDER CONTACT HOLE PATTERNS

HOLE PATTERN SHOWN IS FOR MALE CONNECTOR
USE MIRROR IMAGE FOR FEMALE CONNECTOR

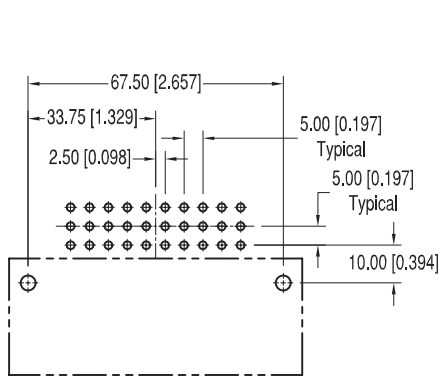

MIP30

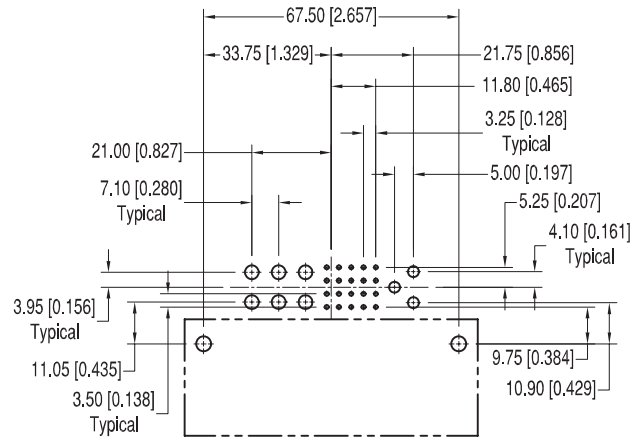

MIP29W9

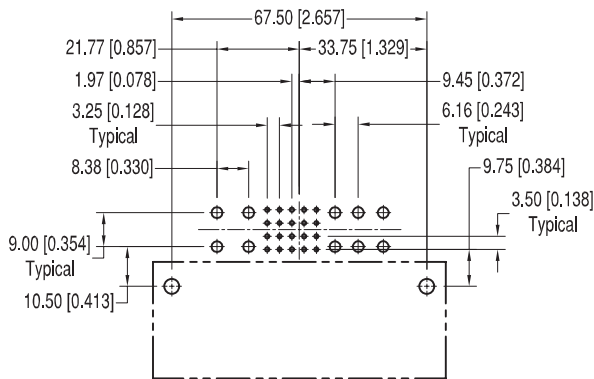

MIP30WA10

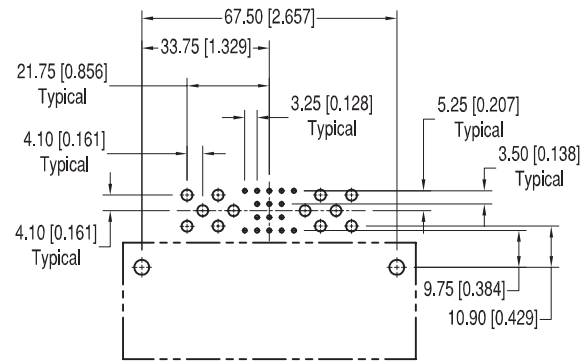

MIP28W12

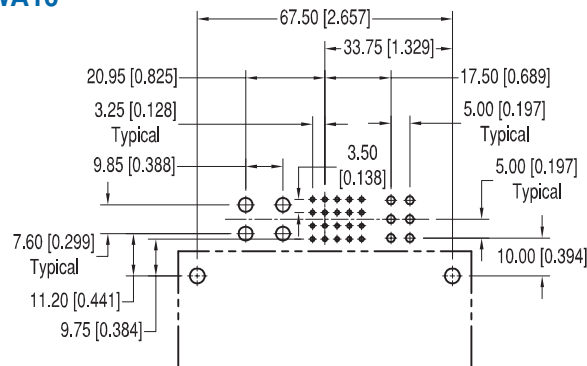

MIP30WB10

SUGGESTED PRINTED BOARD HOLE SIZES:

- Suggested $\phi 1.14$ [0.045] holes for size 20 contact holes.
- Suggested $\phi 2.11$ [0.083] holes for size 16 contact holes.
- Suggested $\phi 2.90$ [0.114] holes for size 12 contact holes.
- Suggested $\phi 3.68$ [0.145] holes for size 8 contact holes.
- Suggested $\phi 3.96 \pm 0.08$ [0.156 \pm 0.003] holes for connector mounting holes.



RIGHT ANGLE (90°) COMPLIANT PRESS-FIT BOARD MOUNT CONNECTORS

CODE 63

MALE AND FEMALE

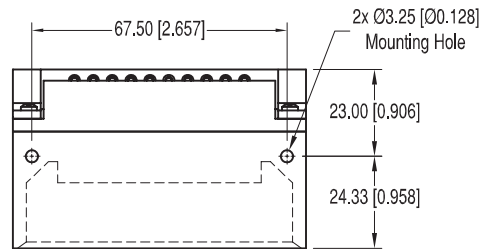

MALE

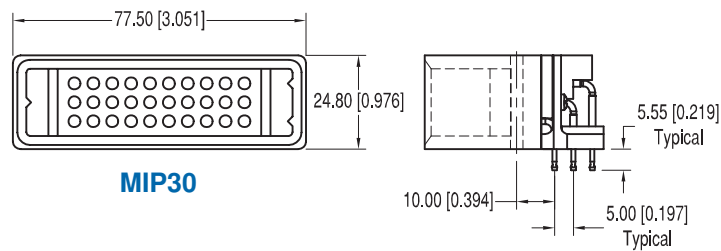

MIP30

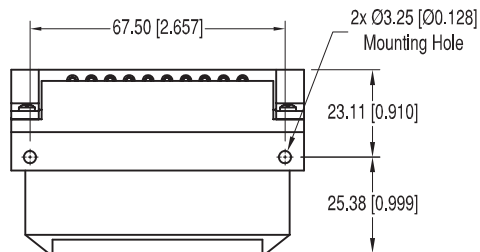

FEMALE

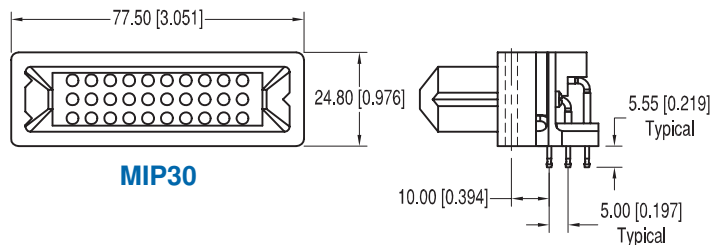

MIP30

RIGHT ANGLE (90°) COMPLIANT PRESS-FIT CONTACT HOLE PATTERN

MALE AND FEMALE

SUGGESTED PRINTED BOARD HOLE SIZES:

NOTE: See page 57 for suggested printed board drill hole sizes, recommended plating and finished hole sizes for compliant contact termination positions.

For press-fit connector installation tools, see pages 55-57.

For mounting screw options, see page 55.

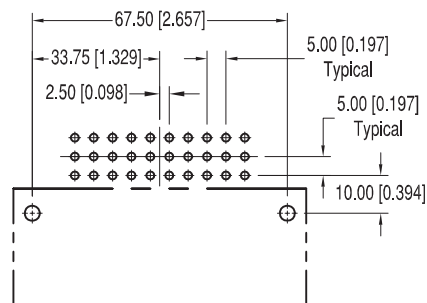

MIP30



ORDERING INFORMATION - CODE NUMBERING SYSTEM

Specify Complete Connector By Selecting An Option From Step 1 Through 7

| STEP | 1 | 2 | 3 | 4 | 5 | 6 | 7 | 8 | 9 |
|---------|-----|------|---|----|---|---|----|-----|---|
| EXAMPLE | MIP | 29W9 | F | 32 | 0 | 0 | A1 | /AA | — |

STEP 1 - BASIC SERIES

MIP - Mini-Infinity

STEP 2 - CONNECTOR VARIANTS

- 24W8 - 2 high performance size 8, 6 size 12 and 16 size 20 contacts. Only available for use with crimp contacts.
- 28W12 - 12 size 12 and 16 size 20 contacts
- 29W9 - 6 size 8, 3 size 12, and 20 size 20 contacts
- 30 - 30 size 16 contacts
- 30WA10 - 10 size 12 and 20 size 20 contacts
- 30WB10 - 4 size 8, 6 size 16, and 20 size 20 contacts

STEP 3 - CONNECTOR GENDER

- M - Male
- F - Female

STEP 4 - CONTACT TERMINATION TYPE

- 0 - Order contacts separately for cable connectors for connection systems 2, 4 and 5. See pages 41-48.
- 3 - Solder, Straight Printed Board Mount with 3.70 [0.146] tail extension for connection systems 1 and 4.
- 32- Solder, Straight Printed Board Mount with 9.58 [0.377] tail extension for connection systems 1 and 4.
- 4 - Solder, Right Angle (90°) Printed Board Mount with 3.70 [0.146] tail extension for connection systems 1, 2, 3 and 7.
- 42- Solder, Right Angle (90°) Printed Board Mount with 9.58 [0.377] tail extension for connection systems 1, 2, 3 and 7.
- 63 - Press-Fit, Compliant Termination Right Angle (90°) Printed Board Mount for use with board thicknesses of 2.29 to 4.45 [0.090 to 0.175]. With cross bar. Connection systems 1, 2, 3 and 7. Available on connector variant 30 only.
- 93 - Press-Fit, Compliant Termination Straight Printed Board Mount for use with board thicknesses of 2.29 to 4.45 [0.090 to 0.175]. Connection systems 1 and 4.

STEP 5 - MOUNTING STYLE

- 0 - None, mounting screws supplied with board mount connector.
- N - Push-on fasteners supplied installed on board mount connector. Not recommended for code 63 and 93.

NOTE: Once you have made a connector selection, contact Technical Sales if you would like to receive a drawing in DXF, PDF format or a 3-dimensional IGES file.

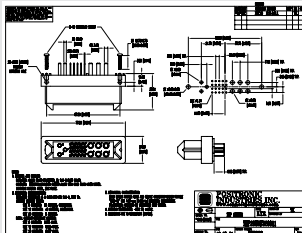

SK Drawing

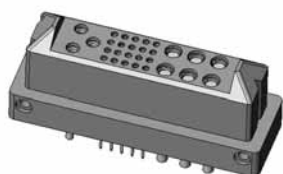

3-dimensional model

STEP 9 - SPECIAL OPTIONS

CONTACT TECHNICAL SALES FOR SPECIAL OPTIONS

- Sequential Mating Systems
- Recessed Female Contacts
- Customer Specified Contact Arrangement
- Hot Plug (see below*)
- Other Customer Requirements

STEP 8 - ENVIRONMENTAL COMPLIANCE OPTIONS

/AA - Compliant per EU Directive 2002/95/EC (RoHS)



NOTE: If compliance to environmental legislation is not required, this step will not be used. Example: MIP29W9F3200A1

STEP 7 - CONTACT PLATING

- 0 - Crimp contacts ordered separately, see pages 41-48.
- A1 - Gold flash over nickel on mating end and termination end.
- A2 - Gold flash over nickel on mating end and 5.00μ [0.00020 inch] tin-lead solder coat on termination end. Not available with code 63 and 93 in Step 4.
- C1 - 0.76μ [0.000030 inch] gold over nickel on mating end and termination end.
- C2 - 0.76μ [0.000030 inch] gold over nickel on mating end and 5.00μ [0.00020 inch] tin-lead solder coat on termination end. Not available with code types 63 and 93 in Step 4.
- D1 - 1.27μ [0.000050 inch] gold over nickel on mating end and termination end.
- D2 - 1.27μ [0.000050 inch] gold over nickel on mating end and 5.00μ [0.00020 inch] tin-lead solder coat on termination end. Not available with code types 63 and 93 in Step 4.

STEP 6 - PANEL MOUNT

- 0 - None.
- 82 - Panel Mount 1.52 [0.060] panel thickness
- 83 - Panel Mount 2.28 [0.090] panel thickness

***Hot Plug Note:** If UL approval is required for a Hot Plug connector, HP must be added to the part number. This is to be prior to any special plating or MOS requirements.

Example part numbers:
MIP28W12M300A1-HP
MIP30WA10M400A1-HP-294.0



TECHNICAL CHARACTERISTICS

MATERIALS AND FINISHES:

| | |
|--------------------------|---|
| Insulator: | Glass-filled polyester, UL 94V-0, blue color. |
| Contacts: | Precision-machined copper alloy with gold flash over nickel, or 0.76 microns [0.000030 inch] gold over nickel, or 1.27 microns [0.000050 inch] gold over nickel. Solder-coated terminations optional. |
| Cable Adapter: | Thermoplastic and metallized plastic. |
| Mounting Screws: | Steel, zinc plated. |
| Jackscrews: | Stainless steel, passivated. Knobs are aluminum with black anodized coating. |
| Push-on Fastener: | Spring-temper copper alloy, tin plated. |
| Mounting Plate: | Steel with zinc plate. |

ELECTRICAL CHARACTERISTICS:

| | |
|--|---|
| Contact Current Rating: | |
| Size 12 Contact: | 40 amperes, continuous |
| Size 16 Contact: | 20 amperes, continuous. |
| Size 20 Contact: | 5 amperes |
| | Temperature Rise Curves per IEC 512-3, Test 5a. See page 31 of this catalog for performance curves. |
| Initial Contact Resistance per IEC 512-2, Test 2b.: | |
| Size 12 Contact: | 0.001 ohms, maximum. |
| Size 16 Contact: | 0.0016 ohms, maximum. |
| Size 20 Contact: | 0.007 ohms |
| Insulator Resistance: | 5 G ohms per IEC 512-2, Test 3a. |
| Voltage Proof: | 2000 V rms per IEC 512-2, Test 4a, Method C. |
| Hot Pluggable (50 Couplings per U.L. 1977, Paragraph 15): | |
| Size 12 Contact: | 250 VAC at 25 amperes. |
| Primary Circuit Contact Positions: | 12-2, 12-5, 12-9, 12-11, 12-14, and 12-18. |
| Secondary Circuit Contact Positions: | 12-1, 12-3, 12-4, 12-6, 12-7, 12-8, 12-10, 12-12, 12-13, 12-15, 12-16, and 12-17. |
| Creepage Distances: | Consult Technical Sales for information about your specific connector choice. |
| Clearance Distance: | Consult Technical Sales for information about your specific connector choice. |
| Working Voltage: | Consult Technical Sales for information about your specific connector choice. |

MECHANICAL CHARACTERISTICS:

| | |
|---|---|
| Blind Mating System: | Male and female connector bodies provide "lead-in" for 7.62 mm [0.300 inch] diametral misalignment. |
| Polarization: | Provided by connector body design. |
| Removable Contacts: | Insert contact in rear face of insulator; release from front face of insulator. Female contacts feature "Closed Entry" design. |
| Removable Contact Retention in Connector Body: | |
| Size 12 Contact: | 67N [15 lbs.] per IEC 512-8, Test 15a. |
| Size 16 Contact: | 67N [15 lbs.] per IEC 512-8, Test 15a. |
| Size 20 Contact: | 44N [10 lbs.] per IEC 512-8, Test 15a. |
| Fixed Contacts: | Printed board terminations, both straight and right angle (90°). Size 12 and 16 female contacts feature "Closed Entry" design. Size 20 female contacts feature "Rugged Open Entry" design. |
| Fixed Contact Retention in Connector Body: | 44N (10 lbs.), minimum. |
| Resistance to Solder Heat: | 260°C (500°F) for 10 seconds duration per IEC 512-6, Test 12e, 25-watt soldering iron. |
| Sequential Contact Mating System: | Two level and three level systems featured. Consult Technical Sales for application assistance with contact sequencing. |
| Safety "Recessed in Insulator" Contacts: | Size 12 and 16 female contacts may be recessed 5.00 mm [0.197 inch] below the face of the female connector insulator per safety requirements. Consult Technical Sales for ordering information. |
| Compliant Press-Fit Terminations: | Size 12, 16 and 20 contacts are available with Compliant Press-Fit Contact Terminations. Consult Technical Sales for electrical and mechanical characteristics. |
| Locking and Coupling System: | Center jackscrew, M4X0.7 thread. Long jackscrews for use with cable adapter or short jackscrews for use without cable adapter. |
| Printed Board and Panel Mounting Holes: | Mounting holes provided in connector body for both printed board and panel mounting. Self-tapping screws or push-on fastener options are available. |
| Mounting Plate with Float Bushings: | Provides up to 2.54 X 4.88 mm [0.100 X 0.192 inch] float. |
| Mechanical Operations: | |
| Systems 1 & 2: | 200 couplings. |
| Systems 3, 4, 5, & 6: | 500 couplings. |
| CLIMATIC CHARACTERISTICS: | |
| Working Temperature: | -55°C to +125°C. |



For RoHS options see page 40.

UL Recognized: File #E49351
CSA Recognized: File #LR54219

CONTACT VARIANTS

FACE VIEW OF MALE OR REAR VIEW OF FEMALE

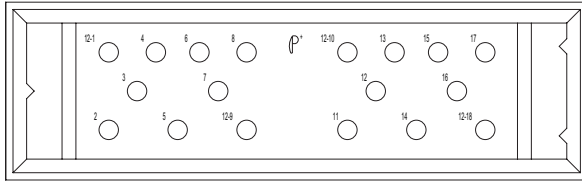

IP18 VARIANT

18 Size 12 Contacts

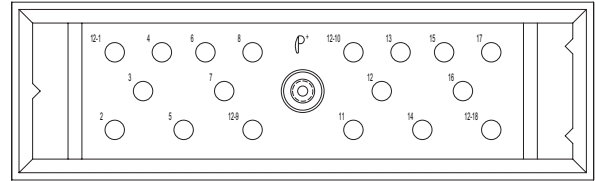

IP18 VARIANT

18 Size 12 Contacts with Jackscrew *

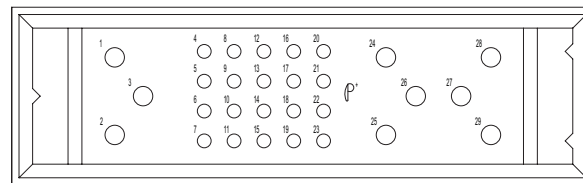

IP29W9 VARIANT

9 Size 12 and 20 Size 16 Contacts

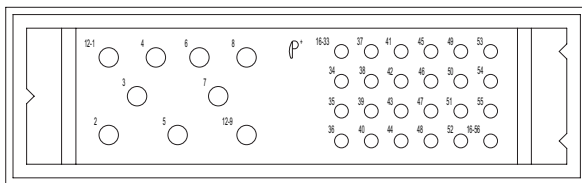

IP33W9 VARIANT

9 Size 12 and 24 Size 16 Contacts

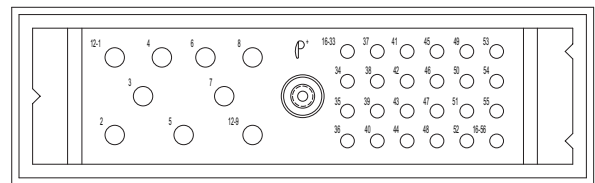

IP33W9 VARIANT

9 Size 12 and 24 Size 16 Contacts with Jackscrew *

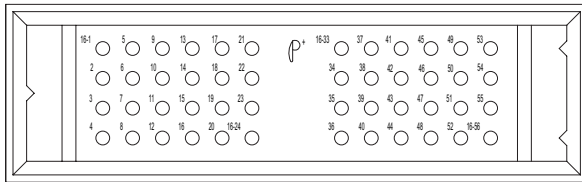

IP48 VARIANT

48 Size 16 Contacts

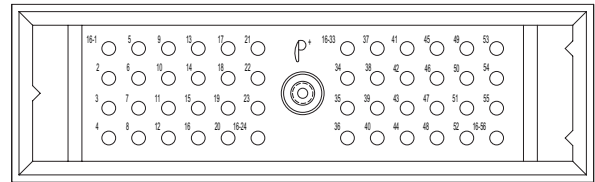

IP48 VARIANT

48 Size 16 Contacts with Jackscrew *

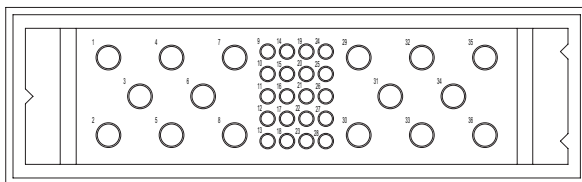

IP36W16 VARIANT

16 Size 12 and 20 Size 20 Contacts

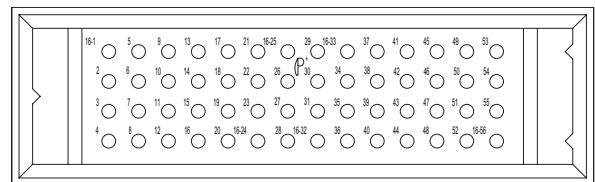

IP56 VARIANT

56 Size 16 Contacts

*** NOTE:**

Male connectors are offered with rotating jackscrews. Female connectors are offered with fixed jackscrews.



TEMPERATURE RISE CURVES TESTED PER IEC PUBLICATION 512-3, TEST 5A

SIZE 16 CONTACTS

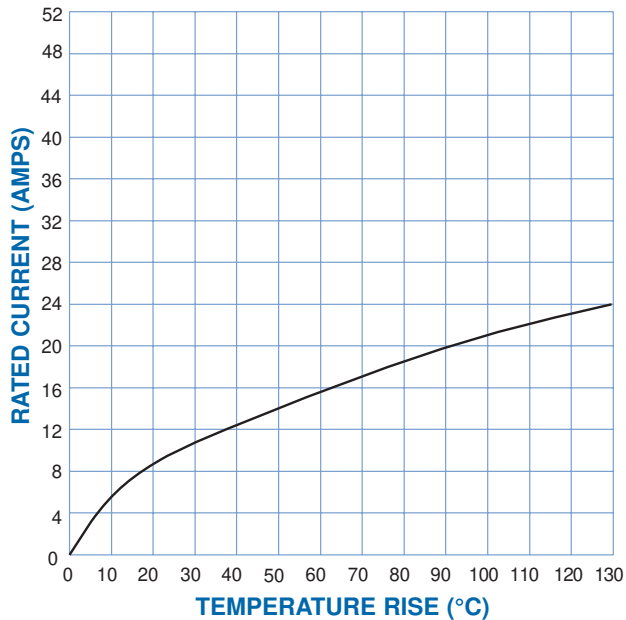

Above curve developed using IP56M400A1 and IP56F300A1 connectors and 12 AWG wire. All contacts under load.

SIZE 12 CONTACTS

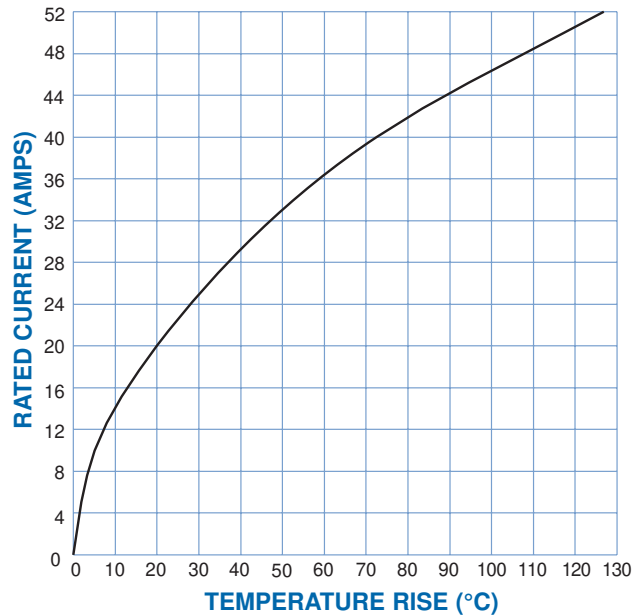

Above curve developed using a IP33W9M0000 connector with MC612N contacts and a IP33W9F0000 connector with FC612N2 contacts and 12 AWG wire on both. All contacts under load. Size 16 contact positions not filled and tested.

NOTE:

These temperature rise curves were developed using standard contact materials. High conductivity contact materials are available. These alternate materials allow for more favorable current carrying performance; consult Technical Sales for details.

CONNECTOR MATING DIMENSIONS

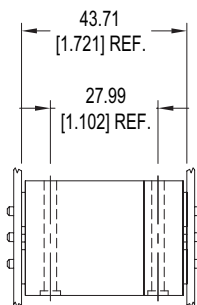

Straight Board Mount or Panel Mount Female to Straight Board Mount or Panel Mount Male.

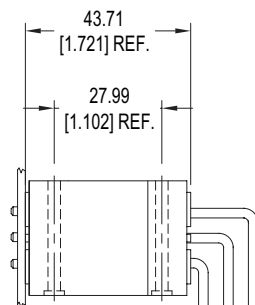

Right Angle (90°) Board Mount Female to Straight Board Mount or Panel Mount Male.

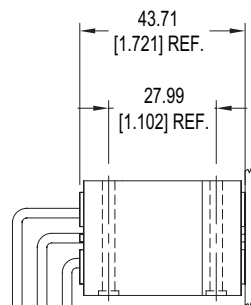

Straight Board Mount or Panel Mount Female to Right Angle (90°) Board Mount Male.

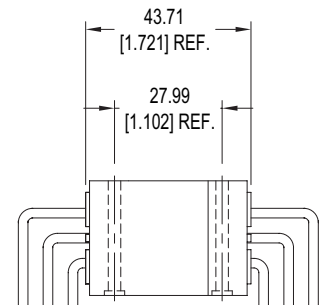

Right Angle (90°) Board Mount Female to Right Angle (90°) Board Mount Male.

CONNECTOR OUTLINE DIMENSIONS FOR USE WITH CODE 0, 3, 32, 93, 4, 42, AND 63

MALE

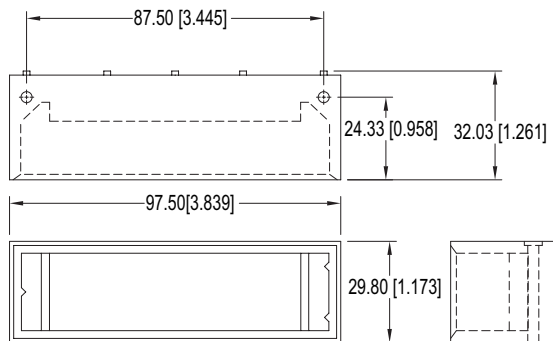

FEMALE

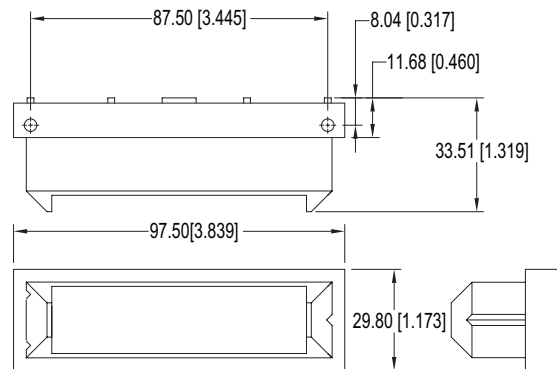

CABLE CONNECTOR

FOR USE WITH SIZE 12, 16 AND 20 REMOVABLE CONTACTS
CODE 0

CONTACTS ARE NOT SUPPLIED WITH CONNECTOR AND MUST BE ORDERED SEPARATELY

MALE

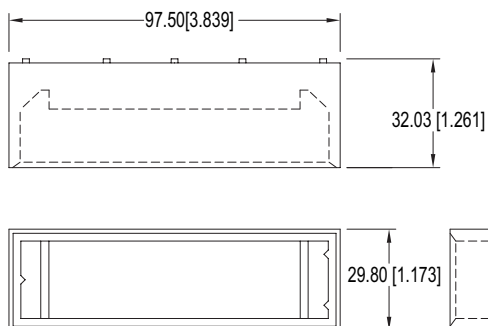

FEMALE

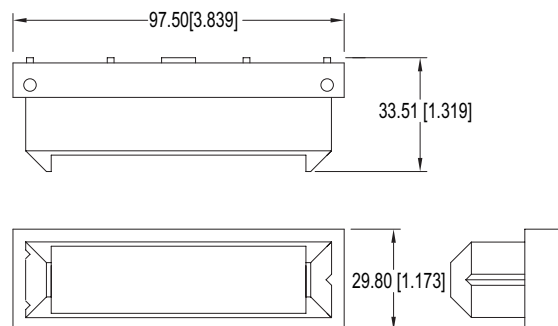

For information regarding size 12, 16 and 20 removable contacts, see Removable Contact section, pages 41-48.



STRAIGHT SOLDER BOARD MOUNT CONNECTORS

CODE 3 AND CODE 32

FEMALE CONNECTOR SHOWN FOR REFERENCE ONLY

| CODE | "A" LENGTH |
|------|--------------|
| 3 | 3.70 [0.146] |
| 32 | 9.58 [0.377] |

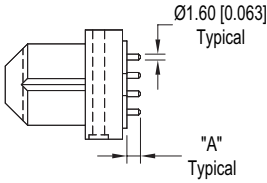
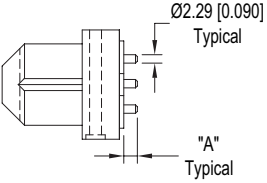
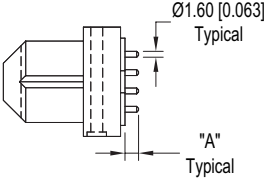
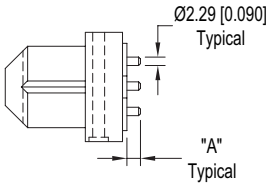
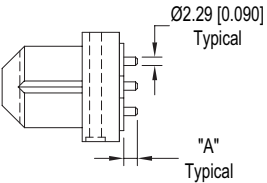
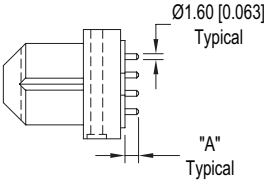
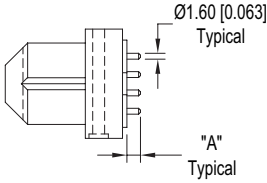
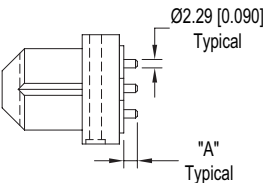
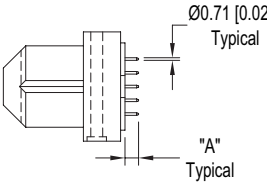
| | | |
|--|---|---|
|  <p>Size 16 contacts</p> <p>IP56</p> |  <p>Size 12 contacts</p> <p>IP33W9</p> |  <p>Size 16 contacts</p> <p>IP33W9</p> |
|  <p>Size 12 contacts</p> <p>IP18</p> |  <p>Size 12 contacts</p> <p>IP29W9</p> |  <p>Size 16 contacts</p> <p>IP29W9</p> |
|  <p>Size 16 contacts</p> <p>IP48</p> |  <p>Size 12 contacts</p> <p>IP36W16</p> |  <p>Size 20 contacts</p> <p>IP36W16</p> |

NOTE:

For customer specific contact extensions below the printed board, contact Technical Sales for ordering information.

STRAIGHT SOLDER CONTACT HOLE PATTERNS

HOLE PATTERN SHOWN IS FOR FEMALE CONNECTOR
USE MIRROR IMAGE FOR MALE CONNECTOR

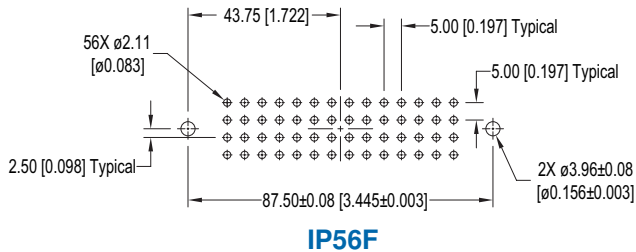

IP56F

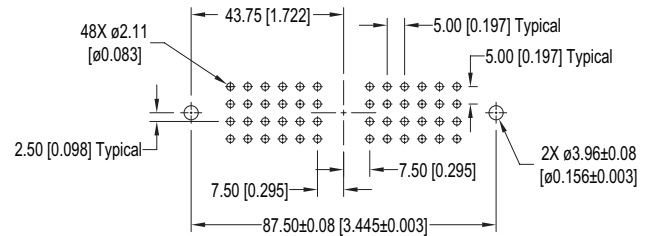

IP48F

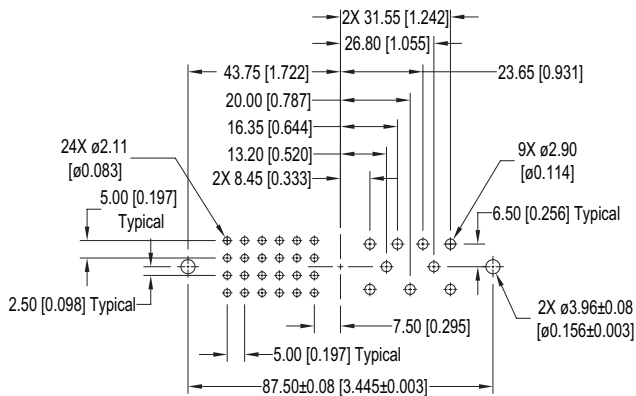

IP33W9F

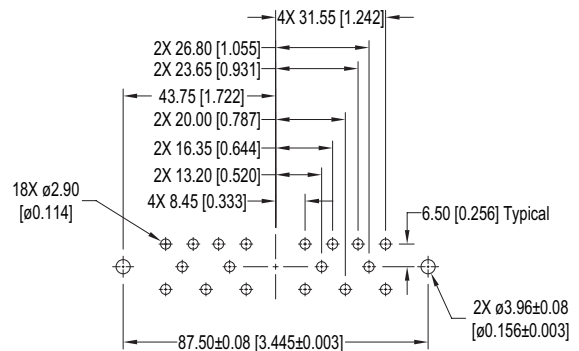

IP18F

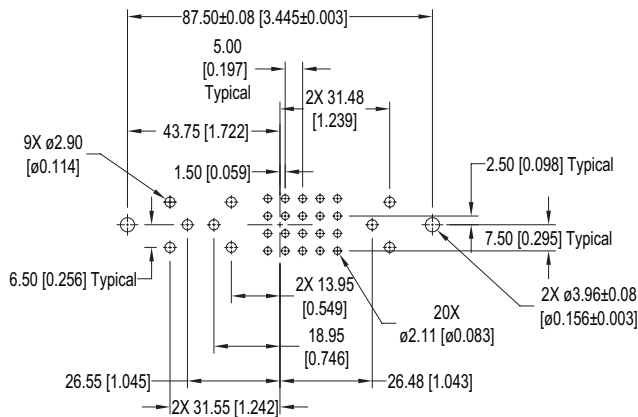

IP29W9F

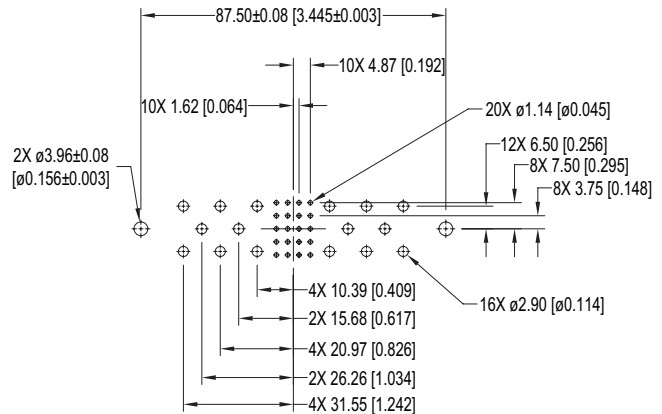

IP36W16F

SUGGESTED PRINTED BOARD HOLE SIZES:

- Suggested $\phi 1.14$ [0.045] holes for size 20 straight contact holes.
- Suggested $\phi 2.11$ [0.083] holes for size 16 straight contact holes.
- Suggested $\phi 2.90$ [0.114] holes for size 12 straight contact holes.
- Suggested $\phi 3.96 \pm 0.08$ [0.156 ± 0.003] holes for connector mounting holes.



STRAIGHT COMPLIANT PRESS-FIT CONNECTORS

CODE 93

FEMALE CONNECTOR SHOWN FOR REFERENCE ONLY

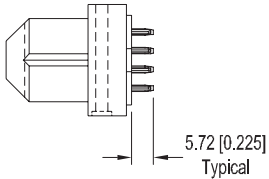
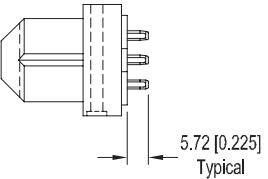
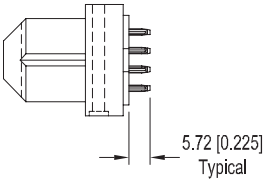
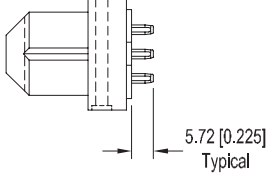
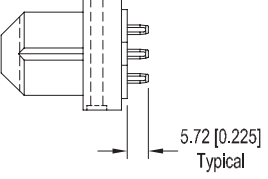
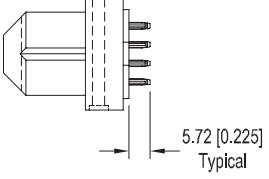
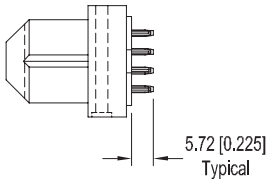
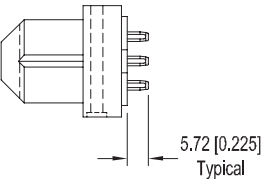
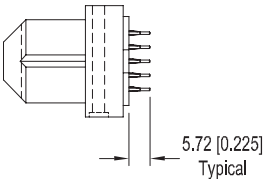
| | | |
|--|--|--|
|  <p>Size 16 contacts</p> <p>IP56</p> |  <p>Size 12 contacts</p> <p>IP33W9</p>  <p>Size 16 contacts</p> | |
|  <p>Size 12 contacts</p> <p>IP18</p> |  <p>Size 12 contacts</p> <p>IP29W9</p>  <p>Size 16 contacts</p> | |
|  <p>Size 16 contacts</p> <p>IP48</p> |  <p>Size 12 contacts</p> <p>IP36W16</p>  <p>Size 20 contacts</p> | |

STRAIGHT COMPLIANT PRESS-FIT CONTACT HOLE PATTERNS

HOLE PATTERN SHOWN IS FOR FEMALE CONNECTOR; USE MIRROR IMAGE FOR MALE CONNECTOR

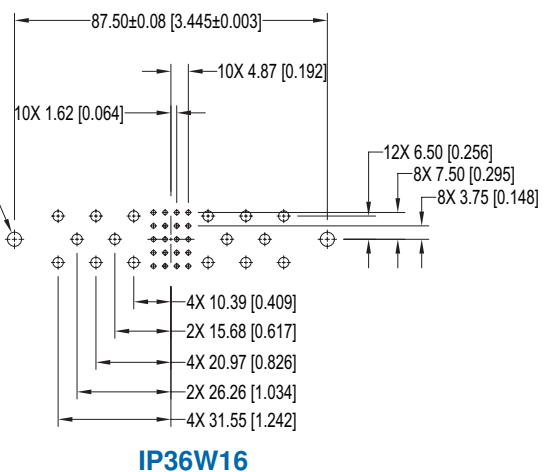
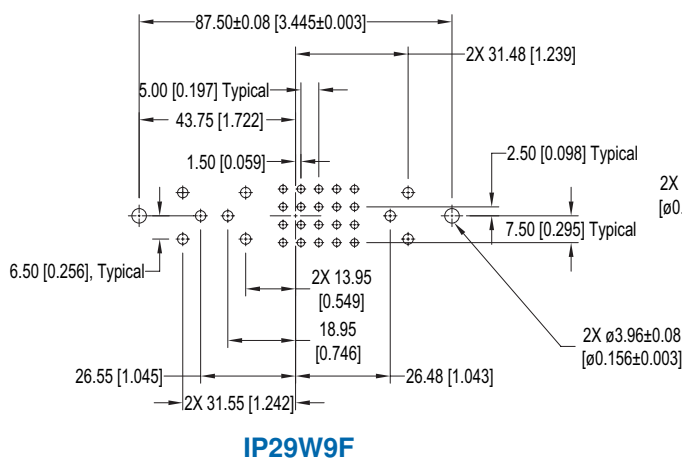
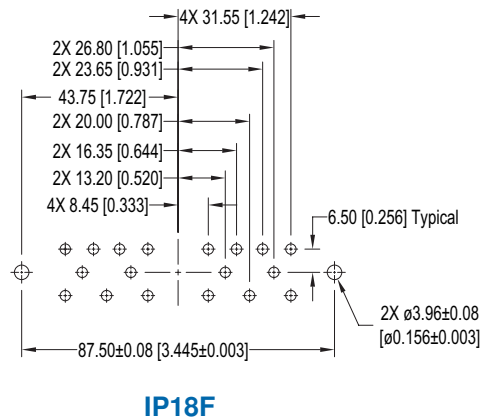
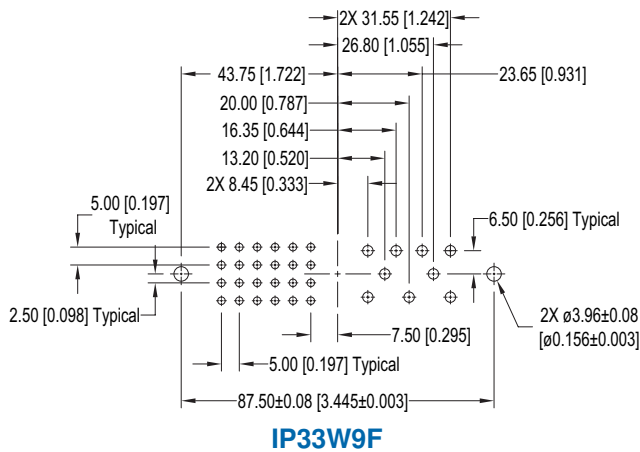
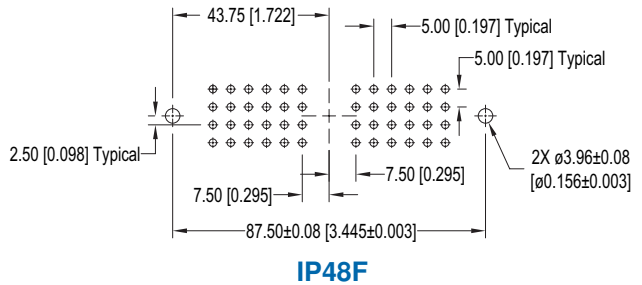
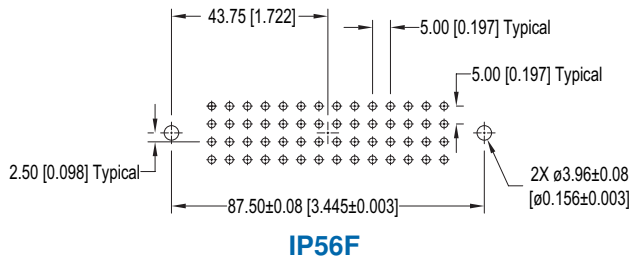

SUGGESTED PRINTED BOARD HOLE SIZES:

NOTE: See page 57 for suggested printed board drill hole sizes, recommended plating and finished hole sizes for compliant contact termination positions.

For press-fit connector installation tools, see pages 55-57.

For mounting screw options, see page 55.



RIGHT ANGLE (90°) SOLDER BOARD MOUNT CONNECTORS

CODE 4 AND CODE 42

FEMALE CONNECTOR SHOWN FOR REFERENCE ONLY

| CODE | "A" LENGTH |
|------|--------------|
| 4 | 3.70 [0.146] |
| 42 | 9.58 [0.377] |



NOTE:

For customer specific contact extensions below the printed board, contact Technical Sales for ordering information.

RIGHT ANGLE (90°) SOLDER CONTACT HOLE PATTERNS

HOLE PATTERN SHOWN IS FOR FEMALE CONNECTOR
USE MIRROR IMAGE FOR MALE CONNECTOR

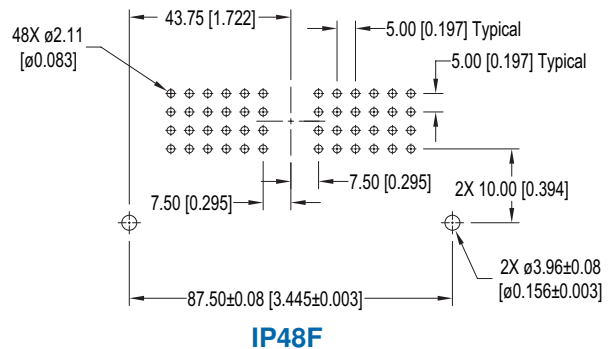
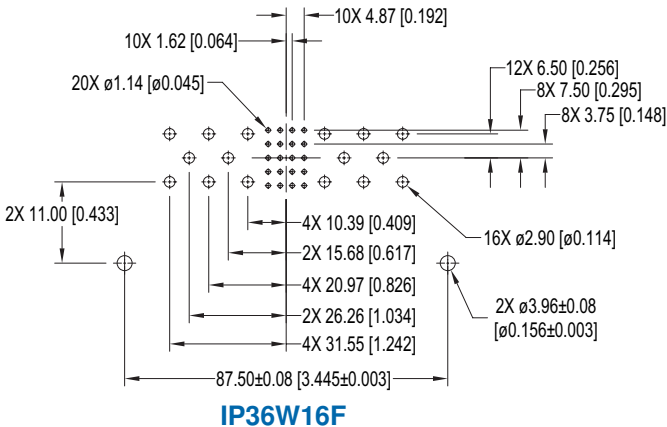
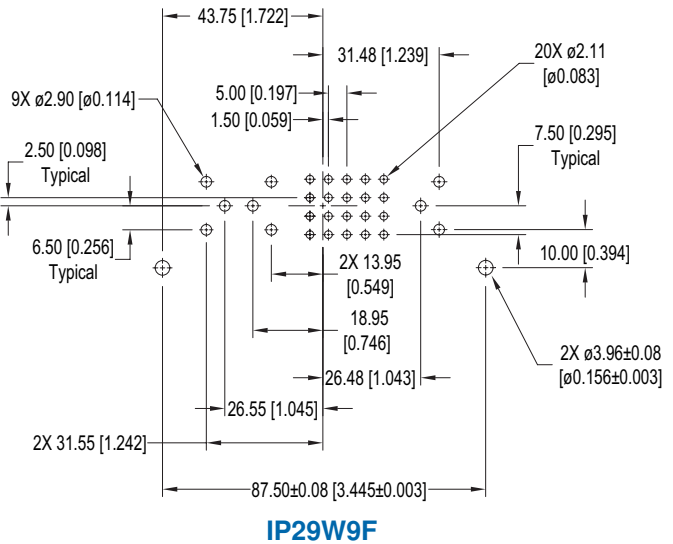
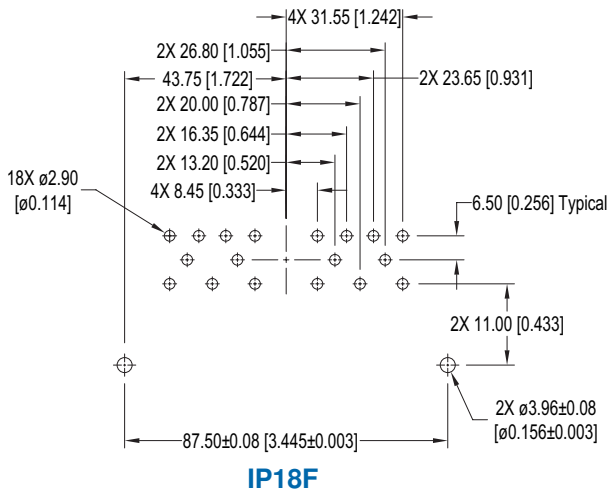
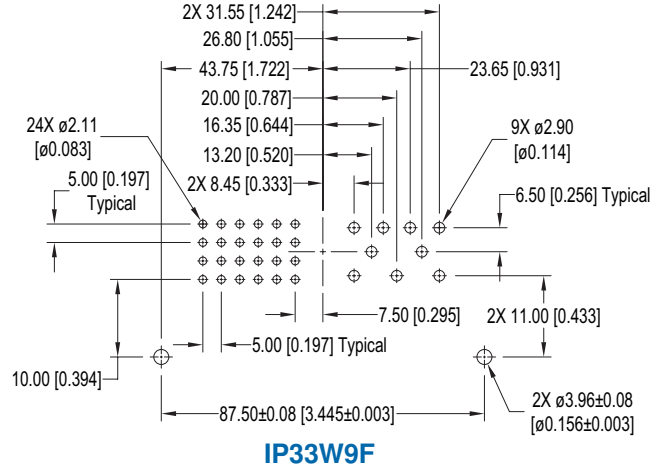
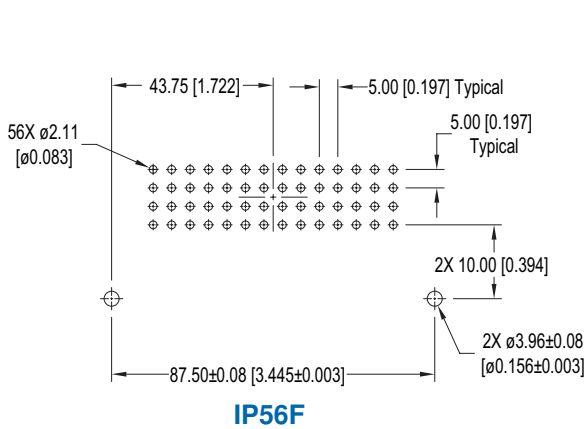

SUGGESTED PRINTED BOARD HOLE SIZES:

- Suggested $\phi 1.14$ [0.045] holes for size 20 straight contact holes.
- Suggested $\phi 2.11$ [0.083] holes for size 16 straight contact holes.
- Suggested $\phi 2.90$ [0.114] holes for size 12 straight contact holes.
- Suggested $\phi 3.96 \pm 0.08$ [0.156 \pm 0.003] holes for connector mounting holes.



RIGHT ANGLE (90°) COMPLIANT PRESS-FIT BOARD MOUNT CONNECTORS CODE 63 MALE AND FEMALE

MALE

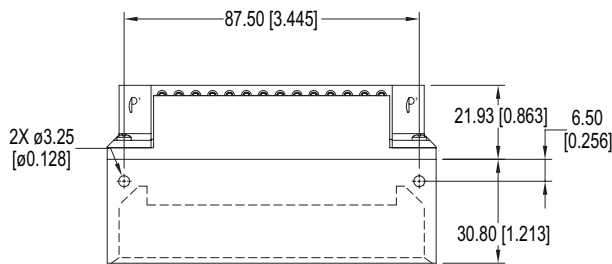

FEMALE

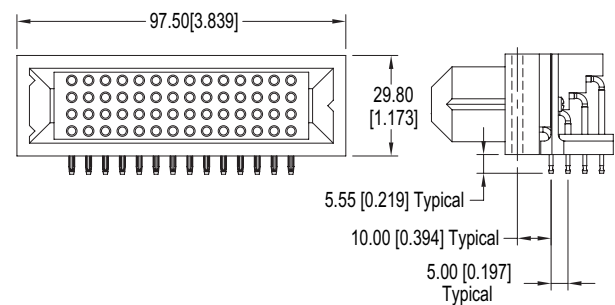
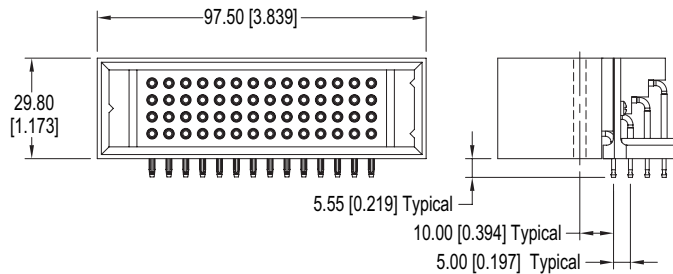
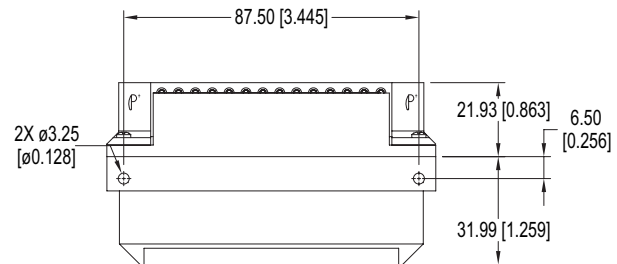

RIGHT ANGLE (90°) COMPLIANT PRESS-FIT CONTACT HOLE PATTERN MALE AND FEMALE

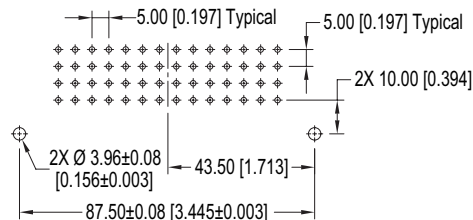

SUGGESTED PRINTED BOARD HOLE SIZES:

NOTE: See page 57 for suggested printed board drill hole sizes, recommended plating and finished hole sizes for compliant contact termination positions.

For press-fit connector installation tools, see pages 55-57.

For mounting screw options, see page 55.



ORDERING INFORMATION - CODE NUMBERING SYSTEM

Specify Complete Connector By Selecting An Option From Step 1 Through 7

| STEP | 1 | 2 | 3 | 4 | 5 | 6 | 7 | 8 | 9 |
|--|----|----|---|---|---|----|---|-----|--|
| EXAMPLE | IP | 48 | M | 0 | J | EL | 0 | /AA | — |
| STEP 1 - BASIC SERIES IP - Infinity | | | | | | | | | |
| STEP 2 - CONNECTOR VARIANTS 56 - 56 size 16 contacts 48 - 48 size 16 contacts 33W9 - 9 size 12 and 24 size 16 contacts 18 - 18 size 12 contacts 29W9 - 9 size 12 and 20 size 16 contacts 36W16 - 16 size 12 and 20 size 20 contacts | | | | | | | | | |
| STEP 3 - CONNECTOR GENDER M - Male F - Female | | | | | | | | | |
| STEP 4 - CONTACT TERMINATION TYPE 0 - Order contacts separately for cable connectors for connection systems 1, 2, 4, 5 and 6. See pages 41-48. 3 - Solder, Straight Printed Board Mount with 3.70 [0.146] tail extension for connection systems 1 and 4. 32 - Solder, Straight Printed Board Mount with 9.58 [0.377] tail extension for connection systems 1 and 4. 4 - Solder, Right Angle (90°) Printed Board Mount with 3.70 [0.146] tail extension for connection systems 1, 2 and 3. 42 - Solder, Right Angle (90°) Printed Board Mount with 9.58 [0.377] tail extension for connection systems 1, 2 and 3. 63 - Press-Fit, Compliant Termination Right Angle (90°) Printed Board Mount for use with board thicknesses of 2.29 to 4.45 [0.090 to 0.175]. With Cross Bar. Connection systems 1 and 2. Connector variant 48 and 56 connectors only. 93 - Press-Fit, Compliant Termination Straight Printed Board Mount for use with board thicknesses of 2.29 to 4.45 [0.090 to 0.175]. Connection systems 1 and 4. | | | | | | | | | |
| STEP 5 - MOUNTING STYLE AND CABLE ADAPTER 0 - None, mounting screws supplied with board mount connector. H - Mounting Plate with Floating Bushings. J - Robust plastic cable adapter N - Push-on fasteners supplied installed on connector. | | | | | | | | | |
| STEP 6 - JACKSCREWS 0 - None. *E - Rotating Male Jackscrew, for use with male connectors without cable adapter only. *EL - Rotating Male Jackscrew, for use with male connectors with cable adapter only. *T - Fixed Female Jackscrew, for use with female connectors only. | | | | | | | | | |
| | | | | | | | | | STEP 9 - SPECIAL OPTIONS CONTACT TECHNICAL SALES FOR SPECIAL OPTIONS • Sequential Mating Systems • Recessed Female Contacts • Customer Specified Contact Arrangement • Other Customer Requirements |
| | | | | | | | | | STEP 8 - ENVIRONMENTAL COMPLIANCE OPTIONS /AA - Compliant per EU Directive 2002/95/EC (RoHS) NOTE: If compliance to environmental legislation is not required, this step will not be used. Example:IP48M0JEL0 |
| | | | | | | | | | STEP 7 - CONTACT PLATING FOR PRINTED BOARD TYPE CONNECTORS 0 - Crimp contacts ordered separately, see pages 41-48. A1 - Gold flash over nickel on mating end and termination end. A2 - Gold flash over nickel on mating end and 5.00μ [0.00020 inch] tin-lead solder coat on termination end. Not available with code 63 and 93 in Step 4. C1 - 0.76μ [0.000030 inch] gold over nickel on mating end and termination end. C2 - 0.76μ [0.000030 inch] gold over nickel on mating end and 5.00μ [0.00020 inch] tin-lead solder coat on termination end. Not available with code types 63 and 93 in Step 4. D1 - 1.27μ [0.000050 inch] gold over nickel on mating end and termination end. D2 - 1.27μ [0.000050 inch] gold over nickel on mating end and 5.00μ [0.00020 inch] tin-lead solder coat on termination end. Not available with code types 63 and 93 in Step 4. |



NOTE: Once you have made a connector selection, contact Technical Sales if you would like to receive a drawing in DXF, PDF format or a 3-dimensional IGES file.

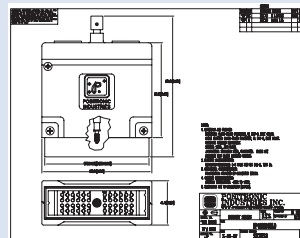

SK Drawing



3-dimensional model

*Available on connector variants 48, 33W9, and 18 only.



Positronic Industries
connectpositronic.com

REMOVABLE CONTACT TECHNICAL CHARACTERISTICS

Infinity
High Power
Connector

REMOVABLE CONTACT TECHNICAL CHARACTERISTICS

SIZE 20 REMOVABLE CONTACT

MATERIALS AND FINISHES:

STANDARD: Precision machined copper alloy with gold flash over nickel. Other finishes are available, see optional plating finishes for -14 and -15.

MECHANICAL CHARACTERISTICS:

STANDARD: Insert contact to rear face of insulator, release from front face of insulator. Size 20 contacts, 1.02 mm [0.040 inch] diameter male contacts, closed entry design female contacts.

ELECTRICAL CHARACTERISTICS:

Contact Current Rating: 5 amperes.
Initial Contact Resistance: 0.007 ohms max. per IEC 512-2, test 2b.

SIZE 16 REMOVABLE CONTACT

MATERIALS AND FINISHES:

STANDARD: Precision machined copper alloy with gold flash over nickel. Other finishes are available, see optional plating finishes for -14 and -15.

HIGH CONDUCTIVITY: Tellurium copper, gold flash over nickel. Other finishes are available, see optional plating finishes for -14 and -15.

MECHANICAL CHARACTERISTICS:

STANDARD AND HIGH CONDUCTIVITY: Insert contact to rear face of insulator, release from front face of insulator. Size 16 contacts, 1.57 mm [0.062 inch] diameter male contacts. Female contact closed entry for highest reliability.

ELECTRICAL CHARACTERISTICS:

STANDARD:
Contact Current Rating: 20 amperes, continuous.
Initial Contact Resistance: 0.0016 ohms max. per IEC 512-2, test 2b.

HIGH CONDUCTIVITY:
Contact Current Rating: Consult Technical Sales for detail information.
Initial Contact Resistance: Consult Technical Sales for detail information.

SIZE 12 REMOVABLE CONTACT

MATERIALS AND FINISHES:

STANDARD: Precision machined copper alloy with gold flash over nickel. Other finishes are available, see optional plating finishes for -14 and -15.

HIGH CONDUCTIVITY: Tellurium copper, gold flash over nickel. Other finishes are available, see optional plating finishes for -14 and -15.

SHIELDED:
Dielectric Material: PTFE teflon
Inner Contacts: Brass & phosphor bronze, 0.000030 inch [0.76 μ] gold over nickel. Other finishes are available, see optional plating finishes for -15.
Outer Contacts: Brass & phosphor bronze, gold flash over nickel. Other finishes are available, see optional finishes for -14.

MECHANICAL CHARACTERISTICS:

STANDARD AND HIGH CONDUCTIVITY: Insert contact to rear face of insulator, release from front face of insulator. Size 12 contacts, 2.39 mm [0.094 inch] diameter male contacts. Female contact closed entry for highest reliability.

SHIELDED: Insert contact to rear face of insulator, release from front face of insulator. Size 12 contacts, 2.39 mm [0.094 inch] diameter male contacts.

Durability: 100 cycles minimum.
Vibration: 20g from 10 Hz to 500 Hz
Shock: 30g - 11 rms

ELECTRICAL CHARACTERISTICS:

STANDARD:
Contact Current Rating: 40 amperes, continuous.
Initial Contact Resistance: 0.001 ohms max. per IEC 512-2, test 2b.

HIGH CONDUCTIVITY:
Contact Current Rating: Consult Technical sales for detail information.
Initial Contact Resistance: Consult Technical sales for detail information.

SHIELDED:
Initial Contact Resistance: 0.010 ohms maximum
Nominal Impedance: 50 ohms
Insulator Resistance: 5 G ohms
***Insertion Loss:** 0.35 dB at 1 GHz
1.35 dB at 2 GHz
1.53 dB at 3 GHz

***VSWR:** 1.20 average at 1 GHz
1.45 average at 2 GHz
1.63 average at 3 GHz
***Proof Voltage:** 600 V r.m.s.

**Above values measured using frequency domain techniques.*

SIZE 8 REMOVABLE CONTACT

MATERIALS AND FINISHES:

STANDARD: Precision machined copper alloy with gold flash over nickel. Other finishes are available, see optional plating finishes for -14 and -15.

HIGH CONDUCTIVITY: Tellurium copper, gold flash over nickel. Other finishes are available, see optional plating finishes for -14 and -15.

HIGH VOLTAGE:
Insulator Material: PTFE teflon
Contacts: Male contacts, brass. Female contacts, phosphor bronze. 0.76 μ [0.000030 inch] gold over nickel. Other finishes are available, see optional plating finishes for -15.

HIGH CURRENT: Tellurium copper, gold flash over nickel. Other finishes are available, see optional plating finishes for -14 and -15.

SHIELDED:
Dielectric Material: PTFE teflon
Inner Contacts: Brass and phosphor bronze, 0.76 μ [0.000030 inch] gold over nickel. Other finishes are available, see optional finishes for -15.
Outer Contacts: Brass and phosphor bronze, gold flash over nickel. Other finishes are available, see optional finishes for -14.

... Continued on next page

For information regarding crimp tool and crimping tool techniques, see Application Tools section, pages 49-54.



REMOVABLE CONTACT TECHNICAL CHARACTERISTICS

Continued from previous page . . .

SIZE 8 REMOVABLE CONTACT

MECHANICAL CHARACTERISTICS:

STANDARD AND HIGH CONDUCTIVITY:

Insert contact to rear face of insulator, release from front face of insulator. Size 8 contacts, 3.61 mm [0.142 inch] diameter male contacts, closed entry design female contacts.

HIGH VOLTAGE:

Insert contact to rear face of insulator, release from front face of insulator. Size 8 contacts. Straight and right angle (90°) terminations. 1.04 mm [0.041 inch] minimum hole diameter.

Durability: 500 cycles minimum.
Vibration: 20g from 10 Hz to 500 Hz
Shock: 30g - 11 ms

HIGH CURRENT:

Insert contact to rear face of insulator, release from front face of insulator. Size 8 contacts, 3.61 mm [0.142 inch] diameter male contacts, closed entry design female contacts.

Durability: 500 cycles minimum.
Vibration: 20g from 10 Hz to 500 Hz
Shock: 30g - 11 ms

SHIELDED:

Insert contact to rear face of insulator, release from front face of insulator. Size 8 contacts, 3.86 mm [0.152 inch] diameter male contacts. See page 48 table of cable sizes for contact termination dimensions.

Durability: 500 cycles minimum.
Vibration: 20g from 10 Hz to 500 Hz
Shock: 30g - 11 ms

ELECTRICAL CHARACTERISTICS:

STANDARD:

Contact Current Rating: 60 amperes, continuous.
Initial Contact Resistance: 0.0005 ohms max. per IEC 512-2, test 2b.

HIGH CONDUCTIVITY:

Contact Current Rating: Consult Technical Sales for detail information.
Initial Contact Resistance: 0.00035 ohms max. per IEC 512-2, test 2b.

HIGH VOLTAGE:

Flash over Voltage: 3600 V r.m.s.
Proof Voltage: 2700 V r.m.s.
Initial Contact Resistance: 0.008 ohms maximum.

HIGH CURRENT:

Contact Current Rating: Consult Technical Sales for detail information.
Initial Contact Resistance: 0.0003 ohms max. per IEC 512-2, test 2b.

SHIELDED:

Initial Contact Resistance: 0.008 ohms maximum.
Nominal Impedance: 50 ohms.
***Insertion Loss:** -0.46 dB at 1 GHz
-1.5 dB at 2 GHz
***VSWR:** 1.15 average at 1 GHz
1.56 average at 2 GHz
***Proof Voltage:** 1000 V r.m.s.
**Above values measured using frequency domain techniques.*

OPTIONAL PLATING FINISHES

- 14 0.76 μ [0.000030 inch] gold over nickel by adding "-14" suffix onto part number. *Example: FC720N2-14.*
- 15 1.27 μ [0.000050 inch] gold over nickel by adding "-15". *Example: FC720N2-15.*

RoHS OPTIONS:

- /AA Environmental Compliance Option (RoHS), compliant per EU Directive 2002/95/EC can be achieved by adding "AA" suffix onto part number. *Examples: FC720N2/AA or for optional finishes use FC720N2/AA-14.*

REMOVABLE CRIMP CONTACT FOR USE WITH MMIP, MIP AND IP SERIES CONNECTORS CONTACTS MUST BE ORDERED SEPARATELY SIZE 20

FEMALE CONTACT
"CLOSED ENTRY" DESIGN

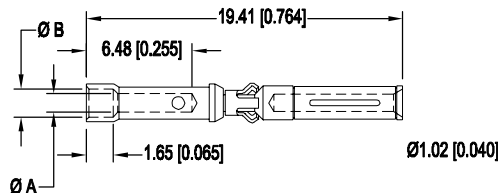

| PART NUMBER | WIRE SIZE AWG/[mm ²] | ØA | ØB |
|-------------|-------------------------------------|-----------------|-----------------|
| FC720N2 | 20 / 22 / 24 [0.5 / 0.3 / 0.25] | 1.14 [0.045] | 1.73 [0.068] |

MALE CONTACT

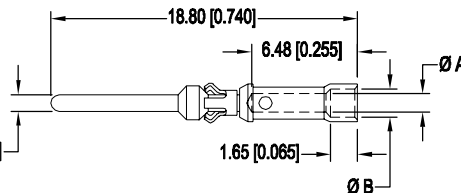

| PART NUMBER | WIRE SIZE AWG/[mm ²] | ØA | ØB |
|-------------|-------------------------------------|-----------------|-----------------|
| MC720N | 20 / 22 / 24 [0.5 / 0.3 / 0.25] | 1.14 [0.045] | 1.73 [0.068] |

For information regarding crimp tool and crimping tool techniques, see Application Tools section, pages 49-54.



Positronic Industries
connectpositronic.com

REMOVABLE CRIMP AND SOLDER CUP CONTACTS, SIZE 16

Infinity
High Power
Connector

REMOVABLE CRIMP CONTACT FOR USE WITH MMIP, MIP AND IP SERIES CONNECTORS CONTACTS MUST BE ORDERED SEPARATELY SIZE 16

*FEMALE CONTACT

"CLOSED ENTRY" DESIGN, L.S.A.

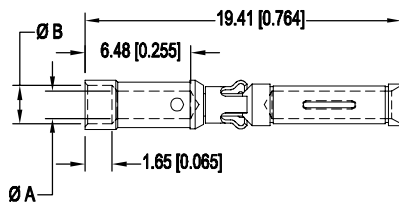

MALE CONTACT

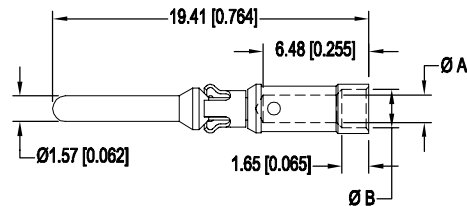

| PART NUMBERS | WIRE SIZE AWG/[mm ²] | ØA | ØB |
|---------------------|----------------------------------|--------------|--------------|
| FC112N2 | 12 [4.0] | 2.49 [0.098] | N/A |
| NEW FC112N2S | 12 [4.0] | 2.49 [0.098] | N/A |
| FC114N2 | 14-16 [2.5-1.5] | 2.06 [0.081] | 2.67 [0.105] |
| FC116N2 | 16-18 [1.5-1.0] | 1.70 [0.067] | 2.36 [0.093] |
| FC120N2 | 20-22-24 [0.5-0.3-0.25] | 1.14 [0.045] | 1.65 [0.065] |

"S" in part number indicates high conductivity material.

| PART NUMBERS | WIRE SIZE AWG/[mm ²] | ØA | ØB |
|--------------------|----------------------------------|--------------|--------------|
| MC112N | 12 [4.0] | 2.49 [0.098] | N/A |
| NEW MC112NS | 12 [4.0] | 2.49 [0.098] | N/A |
| MC114N | 14-16 [2.5-1.5] | 2.06 [0.081] | 2.67 [0.105] |
| MC116N | 16-18 [1.5-1.0] | 1.70 [0.067] | 2.36 [0.093] |
| MC120N | 20-22-24 [0.5-0.3-0.25] | 1.14 [0.045] | 1.65 [0.065] |

*NOTE: Female contacts feature Large Surface Area (L.S.A.) closed entry contact design which provides maximum mating surfaces between male and female contact and reduced contact resistance during operation.



REMOVABLE SOLDER CUP CONTACT FOR USE WITH MMIP, MIP AND IP SERIES CONNECTORS CONTACTS MUST BE ORDERED SEPARATELY SIZE 16

*FEMALE CONTACT

"CLOSED ENTRY" DESIGN, L.S.A.

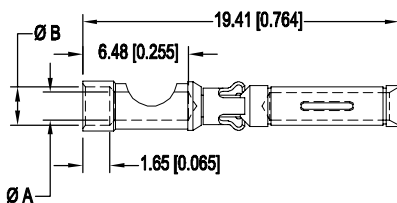

MALE CONTACT

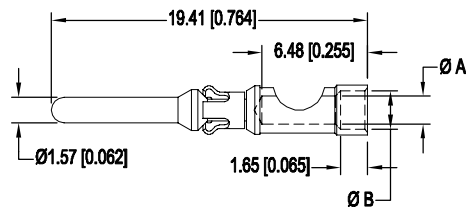

| PART NUMBERS | WIRE SIZE AWG/[mm ²] | ØA | ØB |
|--------------|----------------------------------|--------------|--------------|
| FS112N2 | 12 [4.0] | 2.49 [0.098] | N/A |
| FS112N2S | 12 [4.0] | 2.49 [0.098] | N/A |
| FS114N2 | 14 [2.5] | 2.06 [0.081] | 2.67 [0.105] |
| FS116N2 | 16 [1.5] | 1.70 [0.067] | 2.36 [0.093] |
| FS120N2 | 20 [0.5] | 1.14 [0.045] | 1.65 [0.065] |

"S" in part number indicates high conductivity material.

| PART NUMBERS | WIRE SIZE AWG/[mm ²] | ØA | ØB |
|--------------|----------------------------------|--------------|--------------|
| MS112N | 12 [4.0] | 2.49 [0.098] | N/A |
| MS112NS | 12 [4.0] | 2.49 [0.098] | N/A |
| MS114N | 14 [2.5] | 2.06 [0.081] | 2.67 [0.105] |
| MS116N | 16 [1.5] | 1.70 [0.067] | 2.36 [0.093] |
| MS120N | 20 [0.5] | 1.14 [0.045] | 1.65 [0.065] |

*NOTE: Female contacts feature Large Surface Area (L.S.A.) closed entry contact design which provides maximum mating surfaces between male and female contact and reduced contact resistance during operation.

For information regarding crimp tool and crimping tool techniques, see Application Tools section, pages 49-54.

REMOVABLE CRIMP CONTACT FOR USE WITH MMIP, MIP AND IP SERIES CONNECTORS CONTACTS MUST BE ORDERED SEPARATELY SIZE 12

***FEMALE CONTACT**
"CLOSED ENTRY" DESIGN, L.S.A.

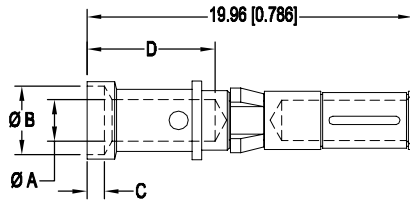

MALE CONTACT

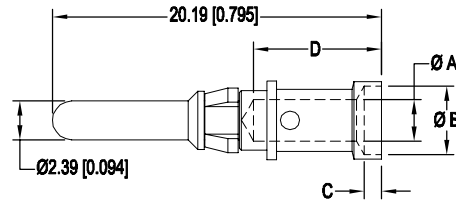

| PART NUMBER | WIRE SIZE AWG/[mm ²] | ØA | ØB | C | D |
|-------------|-------------------------------------|-----------------|-----------------|-----------------|-----------------|
| FC610N2S | 10 [6.0] | 3.73 [0.147] | N/A | N/A | 6.45 [0.254] |
| FC612N2 | 12 [4.0] | 2.54 [0.100] | 4.19 [0.165] | 1.06 [0.042] | 7.85 [0.309] |

"S" in
part number
indicates high
conductivity
material.

| PART NUMBER | WIRE SIZE AWG/[mm ²] | ØA | ØB | C | D |
|-------------|-------------------------------------|-----------------|-----------------|-----------------|-----------------|
| MC610NS | 10 [6.0] | 3.73 [0.147] | N/A | N/A | 6.45 [0.254] |
| MC612N | 12 [4.0] | 2.54 [0.100] | 4.19 [0.165] | 1.06 [0.042] | 7.85 [0.309] |

***NOTE:** Female contacts feature Large Surface Area (L.S.A.) closed entry contact design which provides maximum mating surfaces between male and female contact and reduced contact resistance during operation.



REMOVABLE SOLDER CUP CONTACT FOR USE WITH MMIP, MIP AND IP SERIES CONNECTORS CONTACTS MUST BE ORDERED SEPARATELY SIZE 12

***FEMALE CONTACT**
"CLOSED ENTRY" DESIGN, L.S.A.

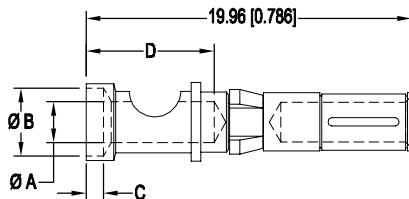

MALE CONTACT

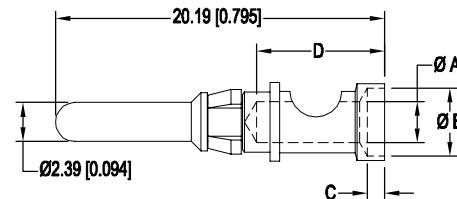

| PART NUMBER | WIRE SIZE AWG/[mm ²] | ØA | ØB | C | D |
|-------------|-------------------------------------|-----------------|-----------------|-----------------|-----------------|
| FS610N2S | 10 [6.0] | 3.73 [0.147] | N/A | N/A | 6.45 [0.254] |
| FS612N2 | 12 [4.0] | 2.54 [0.100] | 4.19 [0.165] | 1.06 [0.042] | 7.85 [0.309] |

"S" in
part number
indicates high
conductivity
material.

| PART NUMBER | WIRE SIZE AWG/[mm ²] | ØA | ØB | C | D |
|-------------|-------------------------------------|-----------------|-----------------|-----------------|-----------------|
| MS610NS | 10 [6.0] | 3.73 [0.147] | N/A | N/A | 6.45 [0.254] |
| MS612N | 12 [4.0] | 2.54 [0.100] | 4.19 [0.165] | 1.06 [0.042] | 7.85 [0.309] |

***NOTE:** Female contacts feature Large Surface Area (L.S.A.) closed entry contact design which provides maximum mating surfaces between male and female contact and reduced contact resistance during operation.

For information regarding crimp tool and crimping tool techniques, see Application Tools section, pages 49-54.



REMOVABLE CRIMP CONTACT FOR USE WITH MIP SERIES CONNECTORS CONTACTS MUST BE ORDERED SEPARATELY SIZE 8

***FEMALE CONTACT**
"CLOSED ENTRY" DESIGN, L.S.A.

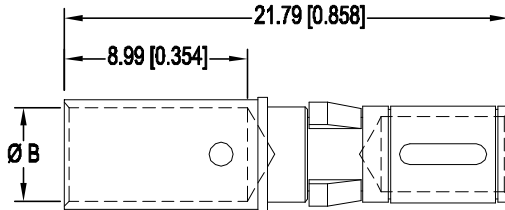

MALE CONTACT

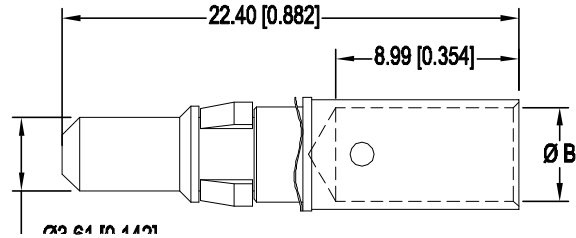

| PART NUMBER | WIRE SIZE AWG/[mm ²] | ØB |
|-------------|-------------------------------------|-----------------|
| FC4008D | 8 / [10.0] | 4.60 [0.181] |
| FC4008DS | 8 / [10.0] | 4.60 [0.181] |
| FC4010D | 10 / [6.0] | 3.10 [0.122] |
| FC4012D | 12 / [4.0] | 2.57 [0.101] |
| FC4016D | 16 / [1.5] | 1.70 [0.067] |

"S" in
part number
indicates high
conductivity
material.

| PART NUMBER | WIRE SIZE AWG/[mm ²] | ØB |
|-------------|-------------------------------------|-----------------|
| MC4008D | 8 / [10.0] | 4.60 [0.181] |
| MC4008DS | 8 / [10.0] | 4.60 [0.181] |
| MC4010D | 10 / [6.0] | 3.10 [0.122] |
| MC4012D | 12 / [4.0] | 2.57 [0.101] |
| MC4016D | 16 / [1.5] | 1.70 [0.067] |

***NOTE:** Female contacts feature Large Surface Area (L.S.A.) closed entry contact design which provides maximum mating surfaces between male and female contact and reduced contact resistance during operation.

For information regarding crimp tool and crimping tool techniques, see Application Tools section, pages 49-54.

REMOVABLE SUPER HIGH CURRENT CRIMP CONTACT

FOR USE WITH MIP24W8 CONNECTORS ONLY
CONTACTS USED WITH 6 AWG WIRE
6 AWG [16.0mm²] max.
CONTACTS MUST BE ORDERED SEPARATELY
SIZE 8

***FEMALE CONTACT**
"CLOSED ENTRY" DESIGN, L.S.A.

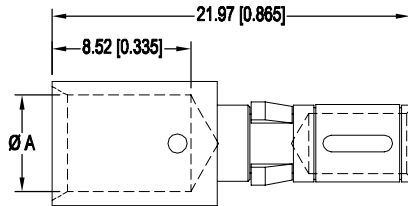

MALE CONTACT

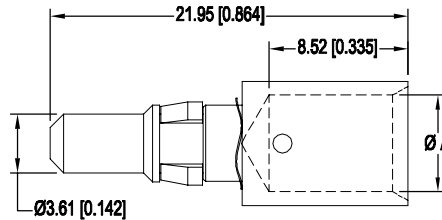

| PART NUMBER | WIRE SIZE AWG [mm ²] | Ø "A" |
|-------------|-------------------------------------|--------------|
| FC4006D | 6 [16.0] | 5.92 [0.233] |

| PART NUMBER | WIRE SIZE AWG [mm ²] | Ø "A" |
|-------------|-------------------------------------|--------------|
| MC4006D | 6 [16.0] | 5.92 [0.233] |

***NOTE:** Female contacts feature Large Surface Area (L.S.A.) closed entry contact design which provides maximum mating surfaces between male and female contact and reduced contact resistance during operation.



REMOVABLE SOLDER CUP CONTACT

FOR USE WITH MIP SERIES CONNECTORS
CONTACTS MUST BE ORDERED SEPARATELY
SIZE 8

***FEMALE CONTACT**
"CLOSED ENTRY" DESIGN, L.S.A.

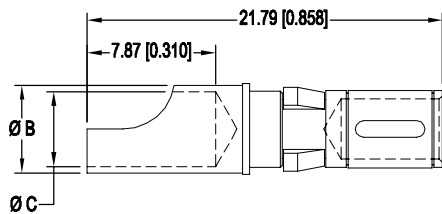

MALE CONTACT

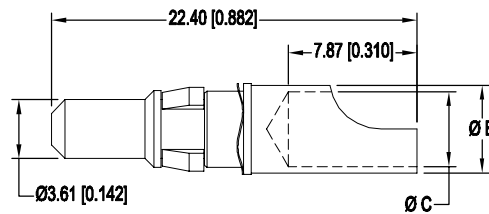

| PART NUMBER | WIRE SIZE AWG [mm ²] | Ø B | Ø C |
|-------------|-------------------------------------|--------------|--------------|
| FS4008D | 8 / [10.0] | 5.56 [0.219] | 4.78 [0.188] |
| FS4012D | 12 / [4.0] | 3.63 [0.143] | 2.84 [0.112] |
| FS4016D | 16 / [1.5] | 2.54 [0.100] | 1.75 [0.069] |

| PART NUMBER | WIRE SIZE AWG [mm ²] | Ø B | Ø C |
|-------------|-------------------------------------|--------------|--------------|
| MS4008D | 8 / [10.0] | 5.56 [0.219] | 4.78 [0.188] |
| MS4012D | 12 / [4.0] | 3.63 [0.143] | 2.84 [0.112] |
| MS4016D | 16 / [1.5] | 2.54 [0.100] | 1.75 [0.069] |

***NOTE:** Female contacts feature Large Surface Area (L.S.A.) closed entry contact design which provides maximum mating surfaces between male and female contact and reduced contact resistance during operation.

For information regarding crimp tool and crimping tool techniques, see Application Tools section, pages 49-54.



Positronic Industries
connectpositronic.com

REMOVABLE HIGH VOLTAGE CRIMP CONTACT, SIZE 8

Infinity
High Power
Connector



REMOVABLE HIGH VOLTAGE CONTACT FOR USE WITH MIP SERIES CONNECTORS CONTACTS MUST BE ORDERED SEPARATELY SIZE 8

STRAIGHT SOLDER WIRE TERMINATION

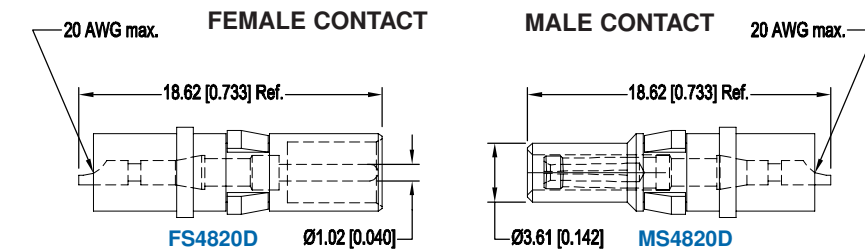

RIGHT ANGLE (90°) SOLDER WIRE TERMINATION

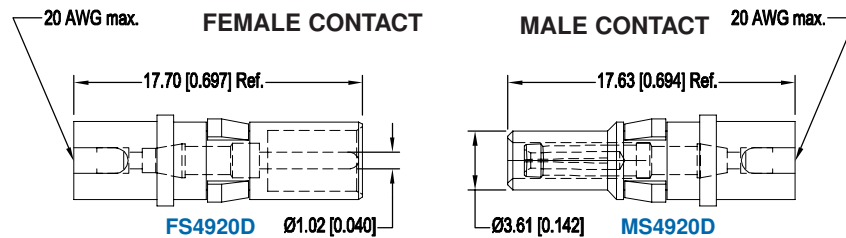

Connectors Designed To Customer Specifications

Positronic connectors can be modified to customers specifications.

Examples: select loading of contacts for cost savings or to gain creepage and clearance distances; longer PCB terminations; customer specified hardware.

Positronic can develop and tool new connector designs with reasonable price and delivery.

Contact Technical Sales with your particular requirements.

For information regarding crimp tool and crimping tool techniques, see Application Tools section, pages 49-54.



REMOVABLE SHIELDED CONTACT
FOR USE WITH MIP SERIES CONNECTORS
CONTACTS MUST BE ORDERED SEPARATELY
SIZE 8

STRAIGHT SOLDER/CRIMP CONTACTS

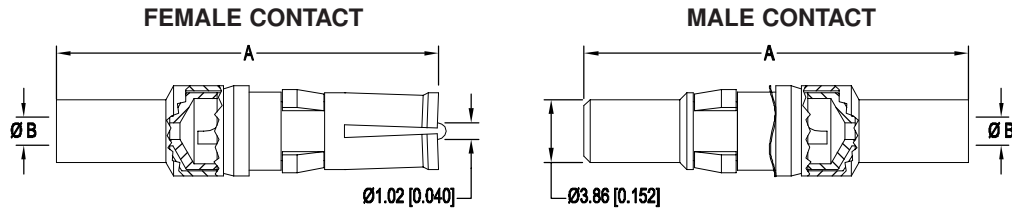

STRAIGHT SOLDER/SOLDER CONTACTS

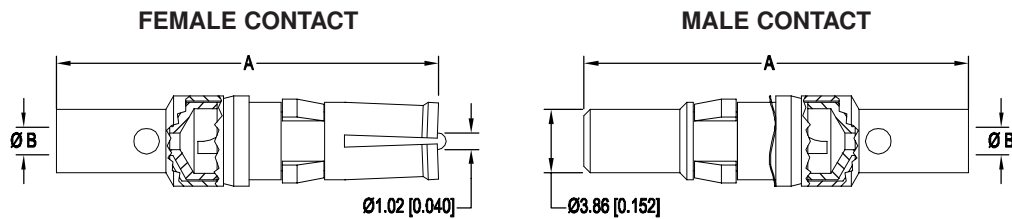

STRAIGHT CRIMP/CRIMP CONTACTS

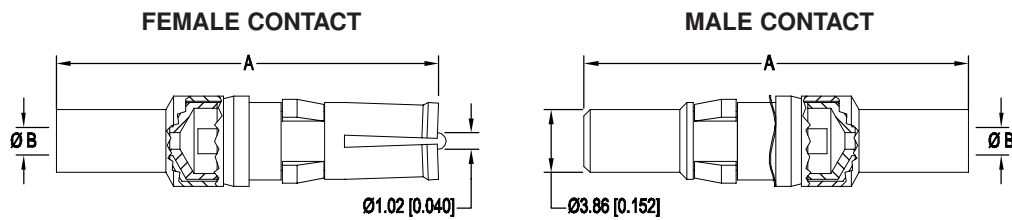

| TYPE OF CONTACT | PART NUMBER | | A | ØB | RG CABLE NUMBER |
|-----------------|-------------|----------|---------------|--------------|--------------------|
| | FEMALE | MALE | | | |
| SOLDER/CRIMP | FC4101D | MC4101D | 23.60 [0.929] | 1.02 [0.040] | 178 B/U 196 B/U |
| SOLDER/CRIMP | FC4102D | MC4102D | 23.60 [0.929] | 1.70 [0.067] | 179 B/U 316 /U |
| SOLDER/CRIMP | FC4103D | MC4103D | 26.34 [1.037] | 2.74 [0.108] | 180 B/U |
| SOLDER/CRIMP | FC4104D | MC4104D | 26.34 [1.037] | 3.05 [0.120] | 58 B/U |
| SOLDER/SOLDER | FS4101D | MS4101D | 23.60 [0.929] | 1.02 [0.040] | 178 B/U 196 B/U |
| SOLDER/SOLDER | FS4102D | MS4102D | 23.60 [0.929] | 1.70 [0.067] | 179 B/U 316 /U |
| SOLDER/SOLDER | FS4103D | MS4103D | 26.34 [1.037] | 2.74 [0.108] | 180 B/U |
| SOLDER/SOLDER | FS4104D | MS4104D | 26.34 [1.037] | 3.05 [0.120] | 58 B/U |
| CRIMP/CRIMP | FCC4101D | MCC4101D | 23.60 [0.929] | 1.02 [0.040] | 178 B/U 196 B/U |
| CRIMP/CRIMP | FCC4102D | MCC4102D | 23.60 [0.929] | 1.70 [0.067] | 179 B/U 316 /U |
| CRIMP/CRIMP | FCC4103D | MCC4103D | 26.34 [1.037] | 2.74 [0.108] | 180 B/U |
| CRIMP/CRIMP | FCC4104D | MCC4104D | 26.34 [1.037] | 3.05 [0.120] | 58 B/U |

Two-step crimping action for signal and shielding conductors.

For information regarding crimp tool and crimping tool techniques, see Application Tools section, pages 49-54.



CRIMPING INFORMATION FOR REMOVABLE CRIMP CONTACTS

USE INDICATED POSITRONIC TOOLS FOR BEST RESULTS

STEP 1: STRIP WIRE TO INDICATED LENGTH.

Correctly Stripped Wire

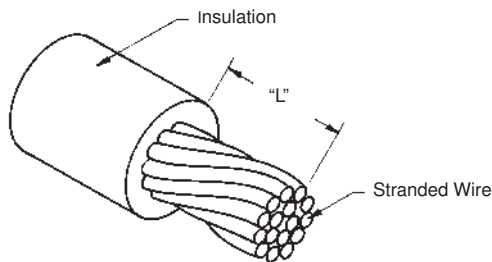

- Take Care Not To:
- Damage or remove strands.
 - Untwist or overtighten strands.
 - Leave insulation particles on strands.
 - Damage insulation.

| CONTACT SIZE | CONTACT PART NUMBER | | "L" ±0.020 [±0.51] |
|--------------|---------------------|----------|-----------------------|
| | FEMALE | MALE | |
| 20 | FC720N2 | MC720N | 5.84 [0.230] |
| 16 | FC1**N2 | MC1**N | 5.84 [0.230] |
| NEW! 16 | FS1**N2 | MS1**N | 5.84 [0.230] |
| NEW! 16 | F*112N2S | M*112NS | 5.84 [0.230] |
| 12 | FC610N2S | MC610NS | 5.84 [0.230] |
| 12 | FC612N2 | MC612N | 7.37 [0.290] |
| NEW! 12 | FS610N2S | MS610NS | 5.84 [0.230] |
| NEW! 12 | FS612N2 | MS612N | 7.37 [0.290] |
| 8 | FC40**D | MC40**D | 8.89 [0.350] |
| NEW! 8 | FS40**D | MS40**D | 8.89 [0.350] |
| NEW! 8 | FC4008DS | MC4008DS | 8.89 [0.350] |
| NEW! 8 | FS4*20D | MS4*20D | 2.54 [0.100] |

Examples of Stripping Faults

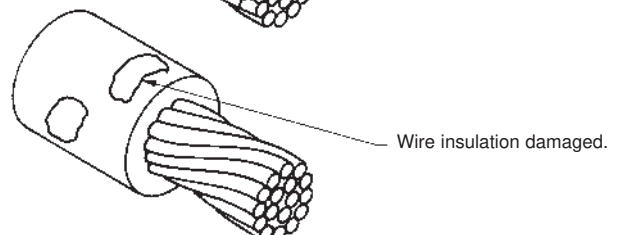
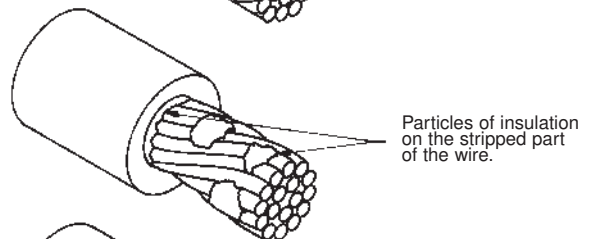
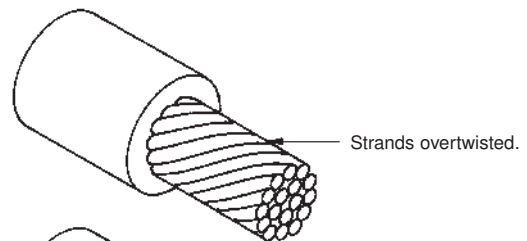
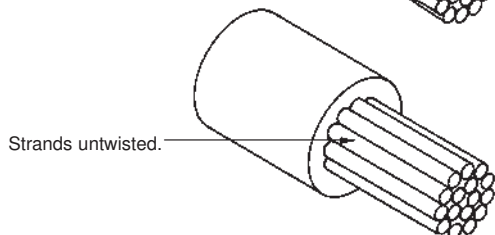
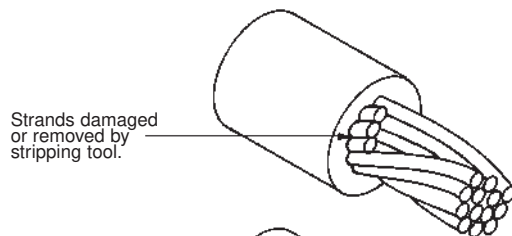

CRIMPING INFORMATION FOR REMOVABLE CRIMP CONTACTS

USE INDICATED POSITRONIC TOOLS FOR BEST RESULTS

STEP 2: CRIMP WIRE TO CONTACT.

- For Hand Crimp Tool:**
- Place contact into crimping tool.
 - Insert wire into contact.
 - Center contact by slowly closing the crimping tool until the crimp indenters make contact with the crimp barrel.
 - Complete the cycle of the crimping tool in one smooth motion.
 - Remove the crimped contact.

- For Automatic Crimp Tool:**
- Insert the wire into the contact, positioned in the crimp tool by the plastic carrier.
 - Depress the activating device of the crimping tool to start the crimping cycle.
 - Remove the crimped contact.

| Positronic Recommended Conductor Tensile Strength | |
|---|-----------------------|
| WIRE SIZE AWG/[mm ²] | AXIAL LOAD POUNDS/[N] |
| 6 [16.0] | 110 [489] |
| 8 [10.0] | 110 [489] |
| 10 [5.3] | 110 [489] |
| 12 [4.0] | 110 [489] |
| 14 [2.5] | 70 [311] |
| 16 [1.5] | 50 [222] |
| 18 [1.0] | 28 [125] |
| 20 [0.5] | 20 [89] |
| 22 [0.3] | 12 [53] |
| 24 [0.25] | 8 [36] |

Conductor tensile strength values are derived using silver-tin plated copper wires.

Values may change depending upon what type of wire is used.

STEP 3: INSPECT THE CRIMP.

Correctly Crimped Contact

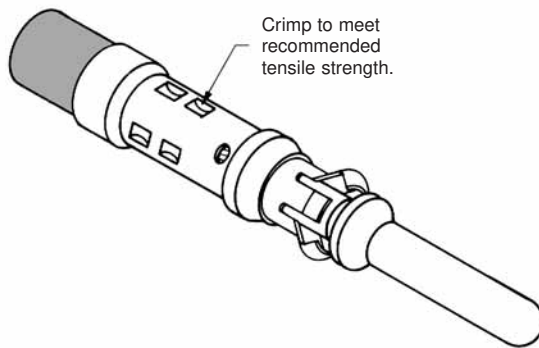

- For All Tools:**
- Strands to be visible through the inspection hole.
 - Strands not to be visible beyond the insulation support.
 - Crimped contact to meet recommended conductor tensile force shown in chart.
 - Check for peeled gold and bent contacts.

Cross Section of Correctly Crimped Contact

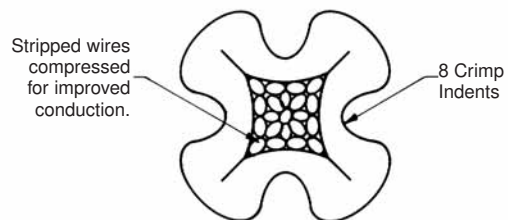

Examples of Crimping Faults

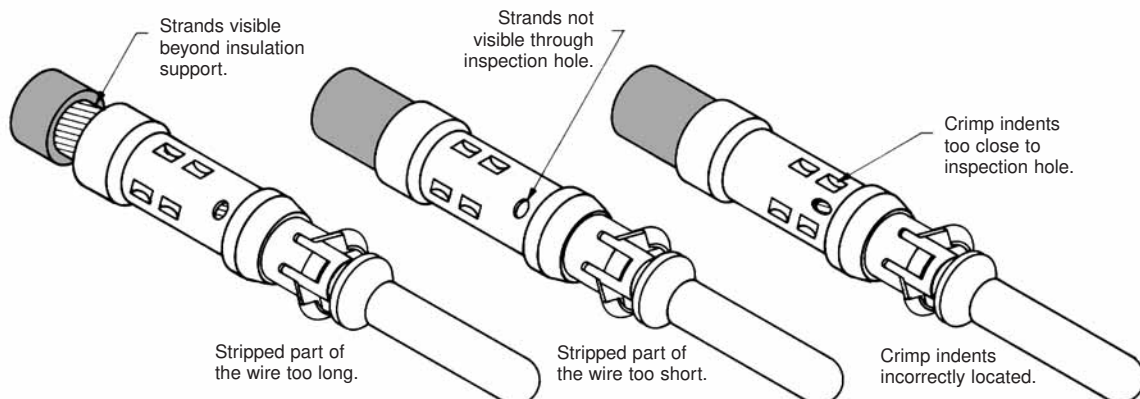



SOLDERING AND CRIMPING INFORMATION FOR SHIELDED CONTACTS

STEP 1: STRIP WIRE TO INDICATED LENGTH

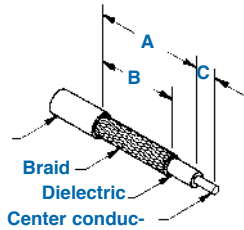

Shielded Contact Hand Crimp Tool

For crimp tool part numbers, see Contact Application Tools Cross Reference Chart on pages 53 & 54.

TAKE CARE NOT TO:

- Damage or remove strands.
- Untwist or overtwist strands.
- Leave insulation particles on strands.
- Damage insulation.

STEP 2: CRIMP WIRE TO CONTACT

- Trim cable.
- Slide ferrule over jacket. Insert dielectric and center conductor into barrel. Crimp center conductor into contact.
- Butt ferrule against shoulder. Crimp ferrule over braid.

STEP 2: SOLDER WIRE TO CONTACT

- Trim cable. Tin center conductor.
- Slide ferrule over jacket. Insert dielectric and center conductor into barrel. Solder center conductor into contact.
- Butt ferrule against shoulder. Solder cable to barrel through hole in ferrule. Solder cap into body.

STEP 2: SOLDER/CRIMP WIRE TO CONTACT

- Trim cable. Tin center conductor.
- Slide ferrule over jacket. Insert dielectric and center conductor into barrel. Solder center conductor into contact.
- Butt ferrule against shoulder. Crimp ferrule over braid. Solder cap into body.

| CONTACT SIZE | PART NUMBER | RG CABLE NUMBER | A | B | C |
|--------------|-------------|-------------------|-----------------|-----------------|-----------------|
| 8 | *C4101D | 178 B/U | 7.14 [0.281] | 6.35 [0.250] | 1.98 [0.078] |
| | *S4101D | | | | |
| | *C4102D | 179 B/U 316 /U | 7.14 [0.281] | 6.35 [0.250] | 1.98 [0.078] |
| | *S4102D | | | | |
| | *C4103D | 180 B/U | 9.53 [0.375] | 7.92 [0.312] | 1.98 [0.078] |
| | *S4103D | | | | |
| | *C4104D | 58 B/U | 9.53 [0.375] | 7.92 [0.312] | 1.98 [0.078] |
| | *S4104D | | | | |
| | *CC4101D | 178 B/U | 7.14 [0.281] | 6.35 [0.250] | 3.05 [0.120] |
| | *CC4102D | | | | |
| | *CC4103D | 180 B/U | 9.53 [0.375] | 7.92 [0.312] | 3.05 [0.120] |
| | *CC4104D | | | | |

*Contact gender is designated by M for male contacts and F for female contacts.

Typical Part Number:
FC4101D

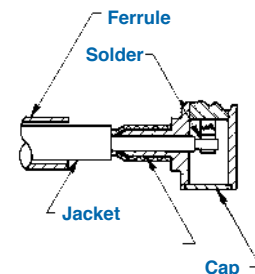
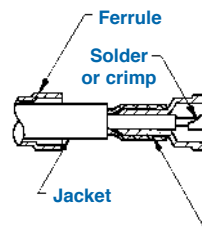

APPLICATION TOOLS

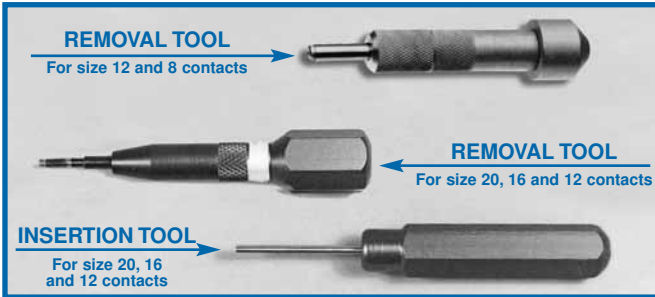

INSERTION AND REMOVAL TOOLS
(SHOWN FOR REFERENCE ONLY)

An easy-to-use contact insertion tool used for rear insertion of contacts into connector, see illustration below.

The contact removal tool is spring-loaded to simplify the extraction of removable contacts from the connector insulators. For contact removal, simply insert the hollow tool tip over the male or female contact from the front face of the insulator, rotate the tool slightly while increasing the pushing force against the butt of the extraction tool. The contact will be released from the insulator retention system and will “pop out” of the rear face of the insulator.

For insertion and removal tool selection part numbers, see Contact Application Tools Cross Reference Chart on pages 53 & 54.

CONTACT INSERTION

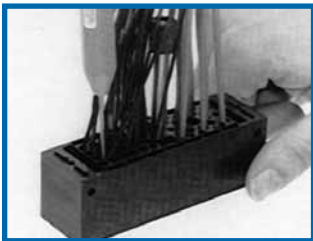

CONTACT REMOVAL

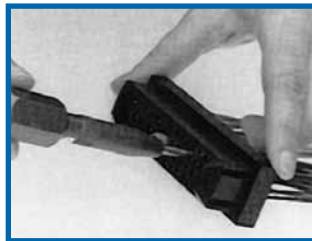

CYCLE-CONTROLLED HAND CRIMP TOOLS
(SHOWN FOR REFERENCE ONLY)

The hand crimp tool, pictured at the top of the image uses 8 AWG wire with produces a hex shaped crimp.

All other wire are eight step adjustable hand crimping tool produces a four double-indent crimp configuration. Each positioner is equipped with a data plate which gives the correct crimp-depth setting for each wire size.

For complete crimp tool and positioner selection part numbers, see Contact Application Tools Cross Reference Chart on pages 53 & 54.



Positronic Industries
connectpositronic.com



CONTACT APPLICATION TOOLS CROSS REFERENCE LIST

Infinity
High Power
Connector

CONTACT APPLICATION TOOLS CROSS REFERENCE LIST

USE INDICATED POSITRONIC TOOLS FOR BEST RESULTS

| M I P S E R I E S | | | | | | | | | | | | | | |
|-------------------|------------------------|-------------------------|---------------------|------------|-------------|-------------|------------|------------|----------------|------------|------------|--------------|------------|------------|
| Contact Size | Positronic Contact P/N | Handle & Positioner P/N | Hand Crimp Tool P/N | Mfg. Cross | Mill Equiv | Positioner | Mfg. Cross | Mill Equiv | Insertion Tool | Mfg. Cross | Mill Equiv | Removal Tool | Mfg. Cross | Mill Equiv |
| 8 | FC4006D | 9504-20-0-0 | 9504-1-0-0 | HX4 | M22520/5-01 | 9504-20-1-0 | Y530 | | | | | 4311-0-0-0 | P+ | |
| 8 | FC4008D | 9504-19-0-0 | 9504-1-0-0 | HX4 | | 9504-19-1-0 | Y524 | | N/A | | | 4311-0-0-0 | P+ | |
| 8 | FC4008DS | 9504-19-0-0 | 9504-1-0-0 | HX4 | | 9504-19-1-0 | Y524 | | N/A | | | 4311-0-0-0 | P+ | |
| 8 | FC4011D | 9509-0-0-0 | 9509-1-0-0 | M310 | | 9509-2-0-0 | TP-974 | | N/A | | | 4311-0-0-0 | P+ | |
| 8 | FC410D | 9504-0-0-0 | 9504-1-0-0 | HX4 | M22520/5-01 | 9504-2-0-0 | Y322 | | N/A | | | 4311-0-0-0 | P+ | |
| 8 | FCC4102D | 9504-14-0-0 | 9504-1-0-0 | HX4 | M22520/5-01 | 9504-14-1-0 | Y878 | | N/A | | | 4311-0-0-0 | P+ | |
| 8 | FCC4102D | 9504-13-0-0 | 9504-1-0-0 | HX4 | M22520/5-01 | 9504-13-1-0 | Y937 | | N/A | | | 4311-0-0-0 | P+ | |
| 8 | FCC4103D | 9504-15-0-0 | 9504-1-0-0 | HX4 | M22520/5-01 | 9504-15-1-0 | Y877 | | N/A | | | 4311-0-0-0 | P+ | |
| 8 | FCC4104D | 9504-15-0-0 | 9504-1-0-0 | HX4 | M22520/5-01 | 9504-15-1-0 | Y877 | | N/A | | | 4311-0-0-0 | P+ | |
| 8 | FS4008D | | | | | | | | | | | 4311-0-0-0 | P+ | |
| 8 | FS4011D | | | | | | | | | | | 4311-0-0-0 | P+ | |
| 8 | FS410D | | | | | | | | | | | 4311-0-0-0 | P+ | |
| 8 | FS4820D | | | | | | | | | | | 4311-0-0-0 | P+ | |
| 8 | FS4920D | | | | | | | | | | | 4311-0-0-0 | P+ | |
| 8 | MC4006D | 9504-20-0-0 | 9504-1-0-0 | HX4 | M22520/5-01 | 9504-20-1-0 | Y530 | | | | | 4311-0-0-0 | P+ | |
| 8 | MC4008D | 9504-19-0-0 | 9504-1-0-0 | HX4 | | 9504-19-1-0 | Y524 | | N/A | | | 4311-0-0-0 | P+ | |
| 8 | MC4008DS | 9504-19-0-0 | 9504-1-0-0 | HX4 | | 9504-19-1-0 | Y524 | | N/A | | | 4311-0-0-0 | P+ | |
| 8 | MC4011D | 9509-0-0-0 | 9509-1-0-0 | M310 | | 9509-2-0-0 | TP-974 | | N/A | | | 4311-0-0-0 | P+ | |
| 8 | MC410D | 9504-0-0-0 | 9504-1-0-0 | HX4 | M22520/5-01 | 9504-2-0-0 | Y322 | | N/A | | | 4311-0-0-0 | P+ | |
| 8 | MCC4101D | 9504-14-0-0 | 9504-1-0-0 | HX4 | M22520/5-01 | 9504-14-1-0 | Y878 | | N/A | | | 4311-0-0-0 | P+ | |
| 8 | MCC4102D | 9504-13-0-0 | 9504-1-0-0 | HX4 | M22520/5-01 | 9504-13-1-0 | Y937 | | N/A | | | 4311-0-0-0 | P+ | |
| 8 | MCC4103D | 9504-15-0-0 | 9504-1-0-0 | HX4 | M22520/5-01 | 9504-15-1-0 | Y877 | | N/A | | | 4311-0-0-0 | P+ | |
| 8 | MCC4104D | 9504-15-0-0 | 9504-1-0-0 | HX4 | M22520/5-01 | 9504-15-1-0 | Y877 | | N/A | | | 4311-0-0-0 | P+ | |
| 8 | MS4008D | | | | | | | | | | | 4311-0-0-0 | P+ | |
| 8 | MS4011D | | | | | | | | | | | 4311-0-0-0 | P+ | |
| 8 | MS410D | | | | | | | | | | | 4311-0-0-0 | P+ | |
| 8 | MS4820D | | | | | | | | | | | 4311-0-0-0 | P+ | |
| 8 | MS4920D | | | | | | | | | | | 4311-0-0-0 | P+ | |

APPLICATION TOOLS



CONTACT APPLICATION TOOLS CROSS REFERENCE LIST

USE INDICATED POSITRONIC TOOLS FOR BEST RESULTS

| Contact Size | Positronic Contact P/N | Handle & Positioner P/N | Hand Crimp Tool P/N | Mfg. Cross | Mill Equiv | Positioner | Mfg. Cross | Mill Equiv | Insertion Tool | Mfg. Cross | Mill Equiv | Removal Tool | Mfg. Cross | Mill Equiv | Automatic Crimp Tool |
|--------------|------------------------|-------------------------|---------------------|------------|-------------|-------------|------------|-------------|----------------|------------|--------------|--------------|------------|--------------|----------------------|
| 20 | FC720N2 | | 9507-0-0-0 | AFM8 | M22520/2-01 | 9502-22-0-0 | K1196 | | 9099-4-0-0 | ITP 1076 | | 9081-2-0-0 | RMG2103 | | 9550-1-0-0 |
| 20 | MC720N | | 9507-0-0-0 | AFM8 | M22520/2-01 | 9502-21-0-0 | K1195 | | 9099-4-0-0 | ITP 1076 | | 9081-2-0-0 | RMG2103 | | 9550-1-0-0 |
| 16 | FC11*N2 | | 9501-0-0-0 | AF8 | M22520/1-01 | 9502-1-0-0 | TH4 | M22520/1-03 | 9099-0-0-0 | ITH 1094 | M81969/18-01 | 9081-0-0-0 | RTG 2103 | M81969/20-01 | 9550-0-0-0 |
| 16 | FC112N2S | 9509-3-0-0 | 9509-4-0-0 | GS222 | | 9509-5-0-0 | TP-1366 | | 9099-0-0-0 | ITH 1094 | M81969/18-01 | 9081-0-0-0 | RTG 2103 | M81969/20-01 | 9550-0-0-0 |
| 16 | FC120N2 | | 9501-0-0-0 | AF8 | M22520/1-01 | 9502-1-0-0 | TH4 | M22520/1-03 | 9099-0-0-0 | ITH 1094 | M81969/18-01 | 9081-0-0-0 | RTG 2103 | M81969/20-01 | 9550-0-0-0 |
| 16 | FS11*N2 | | | | | | | | 9099-0-0-0 | ITH 1094 | M81969/18-01 | 9081-0-0-0 | RTG 2103 | M81969/20-01 | |
| 16 | FS112N2S | | | | | | | | 9099-0-0-0 | ITH 1094 | M81969/18-01 | 9081-0-0-0 | RTG 2103 | M81969/20-01 | |
| 16 | FS120N2 | | | | | | | | 9099-0-0-0 | ITH 1094 | M81969/18-01 | 9081-0-0-0 | RTG 2103 | M81969/20-01 | |
| 16 | MC11*N | | 9501-0-0-0 | AF8 | M22520/1-01 | 9502-1-0-0 | TH4 | M22520/1-03 | 9099-0-0-0 | ITH 1094 | M81969/18-01 | 9081-0-0-0 | RTG 2103 | M81969/20-01 | 9550-0-0-0 |
| 16 | MC112NS | 9509-3-0-0 | 9509-4-0-0 | GS222 | | 9509-5-0-0 | TP-1366 | | 9099-0-0-0 | ITH 1094 | M81969/18-01 | 9081-0-0-0 | RTG 2103 | M81969/20-01 | 9550-0-0-0 |
| 16 | MC120N | | 9501-0-0-0 | AF8 | M22520/1-01 | 9502-1-0-0 | TH4 | M22520/1-03 | 9099-0-0-0 | ITH 1094 | M81969/18-01 | 9081-0-0-0 | RTG 2103 | M81969/20-01 | 9550-0-0-0 |
| 16 | MS11*N | | | | | | | | 9099-0-0-0 | ITH 1094 | M81969/18-01 | 9081-0-0-0 | RTG 2103 | M81969/20-01 | |
| 16 | MS112NS | | | | | | | | 9099-0-0-0 | ITH 1094 | M81969/18-01 | 9081-0-0-0 | RTG 2103 | M81969/20-01 | |
| 16 | MS120N | | | | | | | | 9099-0-0-0 | ITH 1094 | M81969/18-01 | 9081-0-0-0 | RTG 2103 | M81969/20-01 | |
| 12 | FC610N2S | 9509-6-0-0 | 9509-6-1-0 | GS223 | | 9509-6-2-0 | TP-1386 | | 9099-3-0-0 | ITP 1168 | | 2711-0-0-0 | P+ | | 9555-0-2-0 |
| 12 | FC612N2 | | 9501-0-0-0 | AF8 | M22520/1-01 | 9502-19-0-0 | TP1199 | | 9099-3-0-0 | ITP 1168 | | 2711-0-0-0 | P+ | | 9555-0-2-0 |
| 12 | FS612N2 | | | | | | | | 9099-3-0-0 | ITP 1168 | | 2711-0-0-0 | P+ | | |
| 12 | FS610N2S | | | | | | | | 9099-3-0-0 | ITP 1168 | | 2711-0-0-0 | P+ | | |
| 12 | MG610NS | 9509-6-0-0 | 9509-6-1-0 | GS223 | | 9509-6-2-0 | TP-1386 | | 9099-3-0-0 | ITP 1168 | | 2711-0-0-0 | P+ | | 9550-0-0-0 |
| 12 | MG612N | | 9501-0-0-0 | AF8 | M22520/1-01 | 9502-19-0-0 | TP1199 | | 9099-3-0-0 | ITP 1168 | | 2711-0-0-0 | P+ | | 9550-0-0-0 |
| 12 | MS612N | | | | | | | | 9099-3-0-0 | ITP 1168 | | 2711-0-0-0 | P+ | | |

STOOL NOTIFICATION APPLICATION TOOLS



PRESS-FIT USER INFORMATION

When properly used, Positronic Industries' Bi-Spring Power Press-Fit terminations provide reliable service even under severe conditions.

Connectors utilizing this leading technology press-fit contact are easy to install:

1. Choose the proper tooling. Inexpensive insertion tooling and single contact repair tooling are available from Positronic.
2. Insert the connector into the P.C. board or backplane and seat connector fully.
3. Secure the connector to the P.C. board or backplane using two self-tapping screws. The screws should be #6 self-tapping screws for plastic.

MOUNTING SCREWS

Stresses that occur during coupling and uncoupling of connectors or through shock and vibration of systems can be transferred to backplanes or P.C. boards through press-fit connector terminations. Avoid concern over electrical integrity of the connector to board interface by using mounting screws. Bellcore GR1217 details a preference for the use of mounting hardware and we recommend this practice.

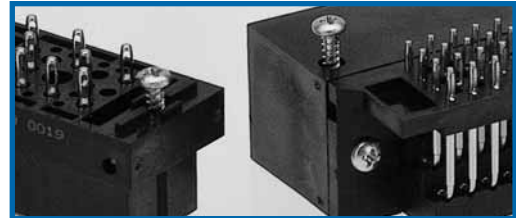

* Mounting screws supplied with board mount connectors

SCREWS ARE #6 SELF-TAPPING FOR PLASTIC.

| Additional Mounting Screw Ordering Information * | | | |
|--|---------------------------|-----------------------------|--|
| SCREW PART NUMBER | FOR USE WITH CONTACT CODE | THREAD LENGTH | P.C. BOARD THICKNESS |
| 2076-12-0-16 | 3, 93 | 9.53±0.76 [0.375±0.030] | 1.52-2.36 [0.060-0.093] Straight mount connectors |
| 2076-12-1-16 | 32, 4, 42, 63 | 12.70±0.76 [0.500±0.030] | All right angle (90°) mount connectors |
| 2076-12-5-16 | | 11.10±0.76 [0.437±0.030] | 3.18 [0.125] Straight mount connectors |

CONSULT TECHNICAL SALES IF AN ALTERNATE SCREW IS REQUIRED.



COMPLIANT PRESS-FIT TERMINATION CONNECTOR INSTALLATION TOOLS

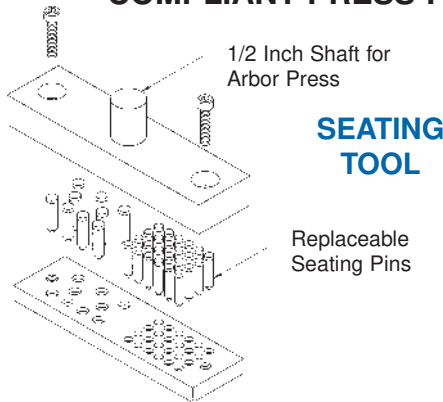

NOTE: Straight mount female connector seating tool shown. Right angle (90°) male and female seating tool not shown. Seating pins are not required for right angle (90°) connector seating tools.

SUPPORT TOOL

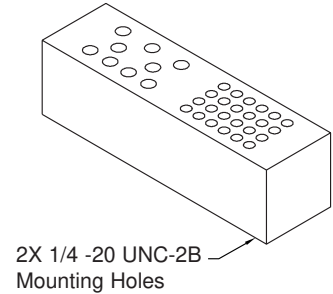

| SERIES | CONNECTOR VARIANT | CONNECTOR SEATING TOOL WITH ARBOR PRESS SHAFT | | CONNECTOR SEATING TOOL WITHOUT ARBOR PRESS SHAFT | | REPLACEMENT PINS | CONNECTOR SUPPORT TOOL |
|--------------------|-------------------------------|---|------------|--|-------------|--|--|
| | | MALE | FEMALE | MALE | FEMALE | FEMALE | |
| MINI-MINI INFINITY | MMIP12W12 (CODE 93) | 9513-307-2 | 9513-306-4 | 9513-307-12 | 9513-306-14 | 855-347-11 | - |
| | MMIP14W9 (CODE 93) | 9513-307-1 | 9513-306-1 | 9513-307-11 | 9513-306-11 | Positions 1-9: 855-347-11 Positions 10-14: 855-347-18 | 9513-403-1 |
| | MMIP18M (CODE 63) | 9513-307-2 | | 9513-307-12 | | - | 9513-403-2 |
| | MMIP18M (CODE 93) | 9513-307-2 | 9513-306-2 | 9513-307-12 | 9513-306-12 | 855-347-3 | 9513-403-2 |
| | MMIP31W6 (CODE 93) | 9513-307-3 | 9513-306-3 | 9513-307-13 | 9513-306-13 | Positions 1-3 through 29-31: 855-347-11 Positions 4-28: 855-347-18 | 9513-403-3 |
| MINI INFINITY | MIP28W12 (CODE 93) | 9513-305-4 | 9513-304-4 | 9513-305-14 | 9513-304-14 | Positions 1-6 through 23-28: 855-347-11 Positions 7-22: 855-347-18 | 9513-402-4 |
| | MIP29W9 (CODE 93) | 9513-305-5 | 9513-304-5 | 9513-305-15 | 9513-304-15 | Positions 1-6: 855-347-17 Positions 7-26: 855-347-18 Positions 27-29: 855-347-11 | 9513-402-5 |
| | MIP30 (CODE 63) | 9513-305-1 | | 9513-305-11 | | - | 9513-402-1 |
| | MIP30 (CODE 93) | 9513-305-1 | 9513-304-1 | 9513-305-11 | 9513-304-11 | 855-347-3 | 9513-402-1 |
| | MIP30WA10 (CODE 93) | 9513-305-2 | 9513-304-2 | 9513-305-12 | 9513-304-12 | Positions 1-4 through 25-30: 855-347-11 Positions 5-24: 855-347-18 | 9513-402-2 |
| | MIP30WB10 (CODE 93) | 9513-305-3 | 9513-304-3 | 9513-305-13 | 9513-304-13 | Positions 1-4: 855-347-17 Positions 5-24: 855-347-18 Positions 25-30: 855-347-11 | 9513-402-3 |
| INFINITY | IP18 (CODE 93) | 9513-303-1 | 9513-302-4 | 913-303-11 | 9513-302-14 | 855-347-11 | 9513-401-3 |
| | IP29W9 (CODE 93) | 9513-303-3 | 9513-302-5 | 9513-303-3 | 9513-302-15 | Positions 1 through 3 and 24 through 29: 855-347-11 Positions 4 through 23: 855-347-3 | 9513-401-4 |
| | IP33W9 (CODE 93) | 9513-303-2 | 9513-302-3 | 9513-303-12 | 9513-302-13 | Positions 12-1 through 12-9: 855-347-11 Positions 16-33 through 16-56: 855-347-3 | 9513-401-6 - for Male 9513-401-2 - for Female |
| | IP36W6 (CODE 93) | 9513-303-4 | 9513-302-7 | 9513-303-14 | 9513-302-17 | Positions 1 through 8 and 29 through 36: 855-347-11 Positions 9 through 28: 855-347-18 | 9513-401-7 |
| | IP48 (CODE 93) | 9513-303-1 | 9513-302-2 | 9513-303-11 | 9513-302-12 | 855-347-3 | 9513-401-1 |
| | IP56 (CODE 63) | 9513-302-6 | | 9513-302-16 | | - | 9513-401-5 |
| | IP56 (CODE 93) | 9513-303-1 | 9513-302-1 | 9513-303-11 | 9513-302-11 | 855-347-3 | 9513-401-1 |



SUGGESTED PRINTED BOARD HOLE SIZES FOR COMPLIANT PRESS-FIT CONNECTORS

Traditionally, tin-lead has been a popular plating for PBC holes. However, many PCB hole platings must now be RoHS Compliant. Positronic is pleased to offer **PCB HOLE SIZE FOR RoHS** PCB plating as shown below.

OMEGA & BI-SPRING COMPLIANT PRESS-FIT CONTACT HOLE

| BOARD TYPE | CONTACT SIZE / TYPE | RECOMMENDED DRILL HOLE SIZE | RECOMMENDED PLATING | FINISHED HOLE SIZES |
|---|---------------------|--|--|---|
| TIN-LEAD SOLDER PCB | 20 OMEGA | $\phi 1.150 \pm 0.025$ [$\phi 0.0453 \pm 0.0010$] | 15 μ [0.0006] minimum solder over 25 μ [0.0010] min. copper | $\phi 1.000 \pm 0.090 - 0.060$ [$\phi 0.0394 \pm 0.0035 - 0.0024$] |
| | 16 BI-SPRING | $\phi 0.069 \pm 0.001$ [$\phi 1.750 \pm 0.025$] | | $\phi 0.0630 \pm 0.0035 - 0.0024$ [$\phi 1.600 \pm 0.090 - 0.060$] |
| | 12 BI-SPRING | $\phi 0.102 \pm 0.001$ [$\phi 2.59 \pm 0.025$] | | $\phi 0.096 \pm 0.002$ [$\phi 2.44 \pm 0.05$] |
| | 8 BI-SPRING | $\phi 0.125 \pm 0.001$ [$\phi 3.180 \pm 0.025$] | | $\phi 0.119 \pm 0.002$ [$\phi 3.02 \pm 0.05$] |
| RoHS PCB PLATING OPTIONS | | | | |
| COPPER PCB | 20 OMEGA | $\phi 1.19 \pm 0.025$ [$\phi 0.047 \pm 0.001$] | 25 μ [0.0010] min. copper | $\phi 1.09 \pm 0.05$ [$\phi 0.043 \pm 0.002$] |
| | 16 BI-SPRING | $\phi 1.750 \pm 0.025$ [$\phi 0.069 \pm 0.001$] | | $\phi 1.600 \pm 0.090 - 0.060$ [$\phi 0.0630 \pm 0.0035 - 0.0024$] |
| | 12 BI-SPRING | $\phi 2.59 \pm 0.025$ [$\phi 0.102 \pm 0.001$] | | $\phi 2.44 \pm 0.05$ $\phi 0.096 \pm 0.002$ |
| | 8 BI-SPRING | $\phi 3.180 \pm 0.025$ [$\phi 0.125 \pm 0.001$] | | $\phi 3.02 \pm 0.05$ [$\phi 0.119 \pm 0.002$] |
| IMMERSION TIN PCB | 20 OMEGA | $\phi 1.19 \pm 0.025$ [$\phi 0.047 \pm 0.001$] | 0.85 \pm 0.15 μ [0.000033 \pm 0.000006] immersion tin over 25 μ [0.0010] min. copper | $\phi 1.09 \pm 0.05$ [$\phi 0.043 \pm 0.002$] |
| | 16 BI-SPRING | $\phi 1.750 \pm 0.025$ [$\phi 0.069 \pm 0.001$] | | $\phi 1.600 \pm 0.090 - 0.060$ [$\phi 0.0630 \pm 0.0035 - 0.0024$] |
| | 12 BI-SPRING | $\phi 2.59 \pm 0.025$ [$\phi 0.102 \pm 0.001$] | | $\phi 2.44 \pm 0.05$ $\phi 0.096 \pm 0.002$ |
| | 8 BI-SPRING | $\phi 3.180 \pm 0.025$ [$\phi 0.125 \pm 0.001$] | | $\phi 3.02 \pm 0.05$ [$\phi 0.119 \pm 0.002$] |
| IMMERSION SILVER PCB | 20 OMEGA | $\phi 1.19 \pm 0.025$ [$\phi 0.047 \pm 0.001$] | 0.34 \pm 0.17 μ [0.000013 \pm 0.000007] immersion silver over 25 μ [0.0010] min. copper | $\phi 1.09 \pm 0.05$ [$\phi 0.043 \pm 0.002$] |
| | 16 BI-SPRING | $\phi 1.750 \pm 0.025$ [$\phi 0.069 \pm 0.001$] | | $\phi 1.600 \pm 0.090 - 0.060$ [$\phi 0.0630 \pm 0.0035 - 0.0024$] |
| | 12 BI-SPRING | $\phi 2.59 \pm 0.025$ [$\phi 0.102 \pm 0.001$] | | $\phi 2.44 \pm 0.05$ $\phi 0.096 \pm 0.002$ |
| | 8 BI-SPRING | $\phi 3.180 \pm 0.025$ [$\phi 0.125 \pm 0.001$] | | $\phi 3.02 \pm 0.05$ [$\phi 0.119 \pm 0.002$] |
| ELECTROLESS NICKEL / IMMERSION GOLD PCB | 20 OMEGA | $\phi 1.19 \pm 0.025$ [$\phi 0.047 \pm 0.001$] | 0.05 μ [0.000002] min. immersion gold over 4.5 \pm 1.5 μ [0.000177 \pm 0.000059] electroless nickel per IPC-4552 over 25 μ [0.0010] min. copper | $\phi 1.09 \pm 0.05$ [$\phi 0.043 \pm 0.002$] |
| | 16 BI-SPRING | $\phi 1.750 \pm 0.025$ [$\phi 0.069 \pm 0.001$] | | $\phi 1.600 \pm 0.090 - 0.060$ [$\phi 0.0630 \pm 0.0035 - 0.0024$] |
| | 12 BI-SPRING | $\phi 2.59 \pm 0.025$ [$\phi 0.102 \pm 0.001$] | | $\phi 2.44 \pm 0.05$ $\phi 0.096 \pm 0.002$ |
| | 8 BI-SPRING | $\phi 3.180 \pm 0.025$ [$\phi 0.125 \pm 0.001$] | | $\phi 3.02 \pm 0.05$ [$\phi 0.119 \pm 0.002$] |

“Omega” Termination



“Bi-Spring” Termination

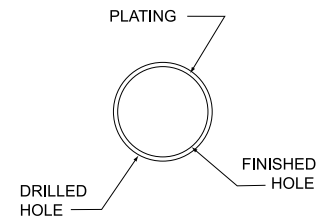

COMPLIANT PRESS-FIT TERMINATION CONTACT HOLE

NOTE: For PCB plating compositions not shown, consult Technical Sales.

APPLICATION TOOLS

PANEL MOUNTING PLATE WITH FLOATING BUSHINGS

CODE H ON STEP 5 OF ORDERING INFORMATION PAGE

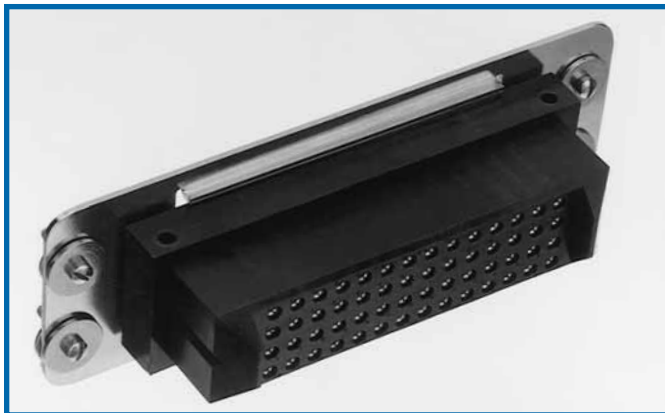
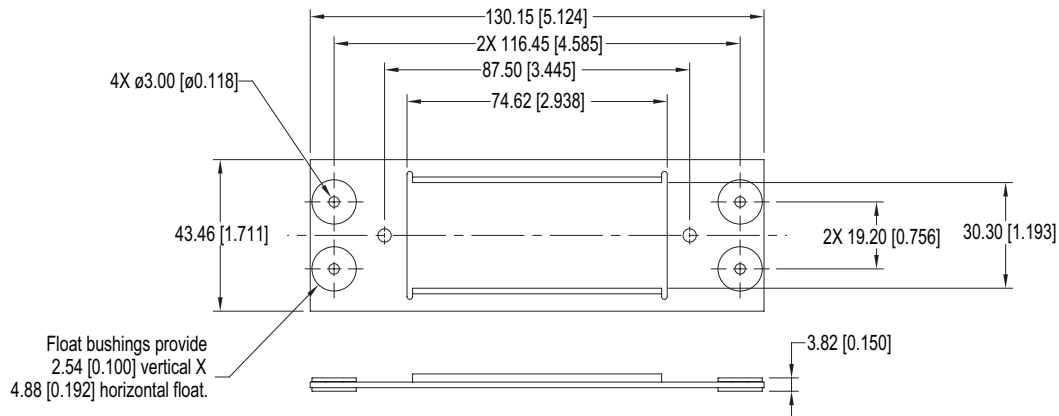

RECOMMENDED PANEL THICKNESS:
1.52 [0.060] - 2.36 [0.093].

MOUNTING SCREWS ARE SUPPLIED WITH CONNECTOR.

MATERIALS AND FINISHES:

Mounting Plate: Steel with zinc plate and chromate seal.

Floating Bushings: Brass with zinc plate and chromate seal.

FLOATING BUSHING PANEL MOUNTING CUTOUT

CONNECTOR MOUNTED TO THE PANEL USING THE FLOATING BUSHING MOUNTING PLATE (SHOWN ABOVE).

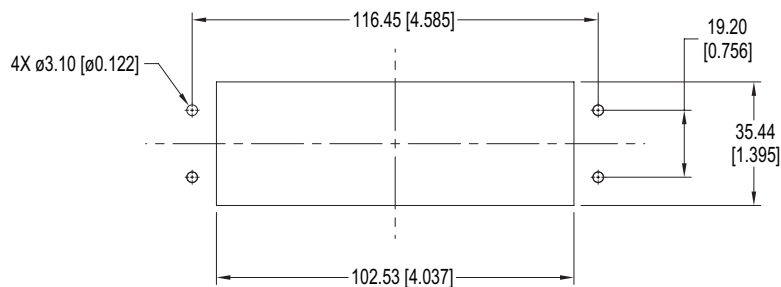

DIRECT MOUNTING PANEL CUTOUT

CONNECTOR MOUNTED DIRECTLY TO THE PANEL

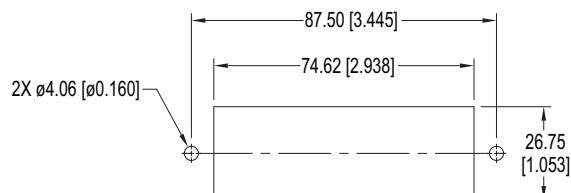

RECOMMENDED PANEL THICKNESS:
1.52 [0.060] - 2.36 [0.093].

SELF-TAPPING MOUNTING SCREWS ARE SUPPLIED WITH CONNECTOR.



CONNECTOR MOUNTING STYLE OPTIONS AND PANEL FLOAT MOUNT AND CUTOUT

CONNECTOR MOUNTING STYLE OPTIONS

CODE 0 AND CODE N ON STEP 5 OF ORDERING INFORMATION PAGE

CODE 0
SELF-TAPPING MOUNTING SCREWS

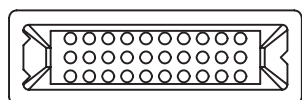
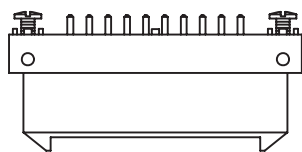

MIP30F300A1

SHOWN FOR REFERENCE

CODE N
PUSH-ON FASTENER

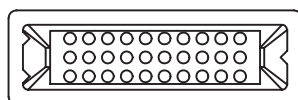
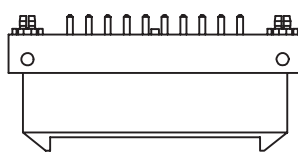

MIP30F3N0A1

SHOWN FOR REFERENCE

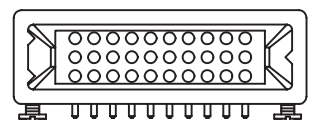
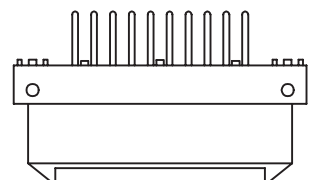
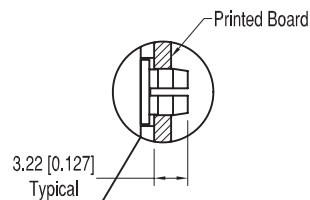

MIP30F400A1

SHOWN FOR REFERENCE

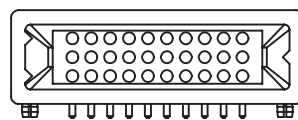
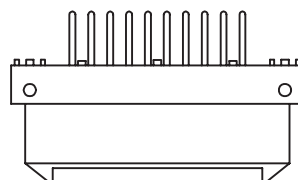

MIP30F4N0A1

SHOWN FOR REFERENCE

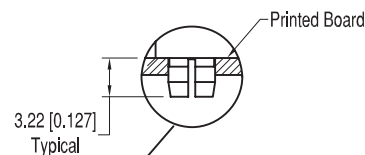

PANEL FLOAT MOUNT

CODE 82 AND CODE 83 ON STEP 6 OF ORDERING INFORMATION PAGE

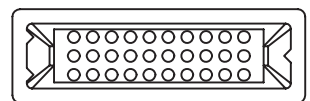
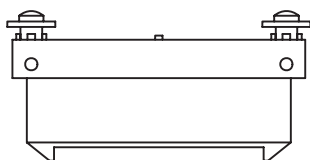

MIP30F00820

SHOWN FOR REFERENCE

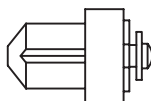

| PART NUMBER | PANEL THICKNESS |
|-------------|-----------------|
| *IP****82* | 1.52 [0.060] |
| *IP****83* | 2.28 [0.090] |

Panel float mount system provides lead-in for 2.03 [0.080] axial misalignment. Additional panel thickness may be available. Consult Technical Sales for availability.

FLOAT MOUNT PANEL CUTOUT

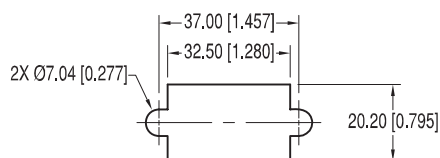
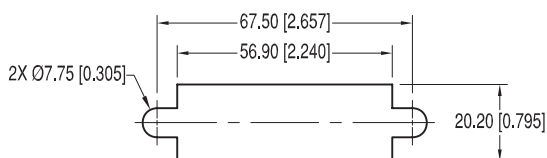



CABLE ADAPTERS

CODE J ON STEP 5 OF ORDERING INFORMATION PAGE
SUPPLIED WITH OR WITHOUT JACKSCREW

MATERIALS AND FINISHES:

- Hood:** Polyester.
- JackscREW:** Stainless steel, passivated.
- Knob:** Aluminum, anodized.

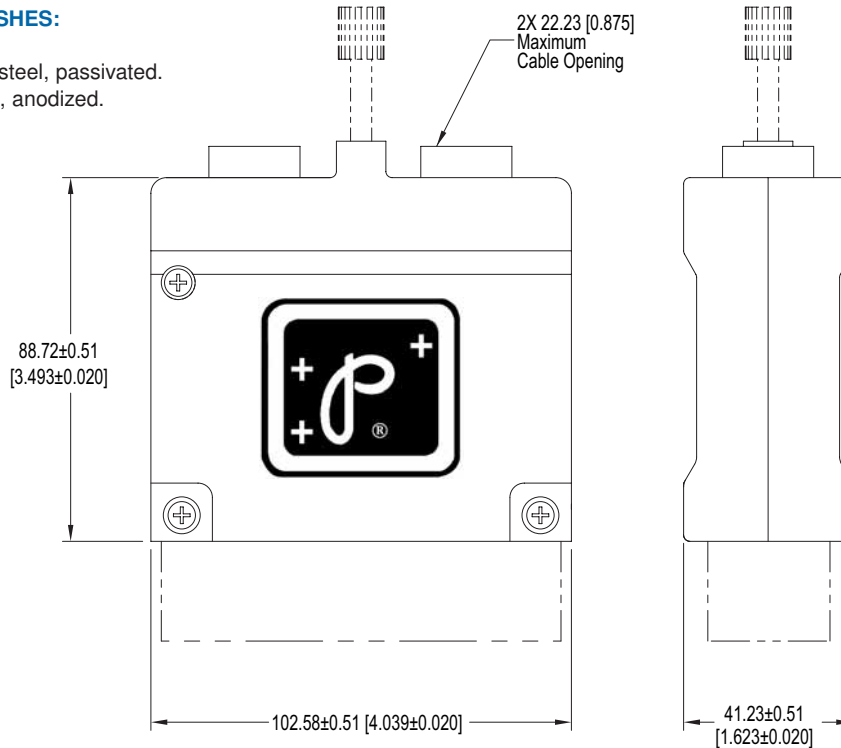

**CABLE ADAPTER
WITHOUT JACKSCREW**
EXAMPLE PART NUMBER:
IP48M0J00

**FOR CABLE ADAPTER
WITH JACKSCREW**
EXAMPLE PART NUMBER:
IP48M0JELO

FIXED FEMALE JACKSCREW

CODE T ON STEP 6 OF ORDERING INFORMATION PAGE
PANEL MOUNT AND CABLE CONNECTORS SUPPLIED WITH OR WITHOUT FIXED JACKSCREWS

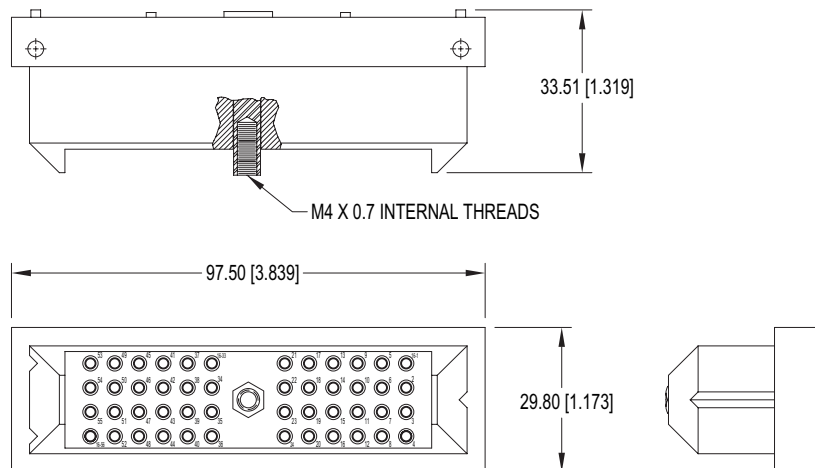

IP56F0000

For information regarding size 12, 16 and 20 removable contacts, see Removable Contact section, pages 41-48.



ROTATING MALE JACKSCREW

CODE EL AND CODE E ON STEP 6 OF ORDERING INFORMATION PAGE

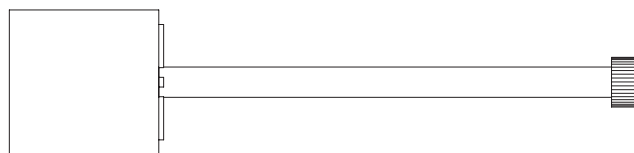
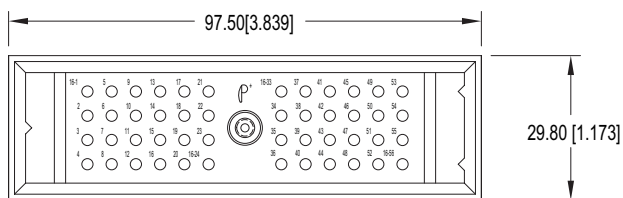
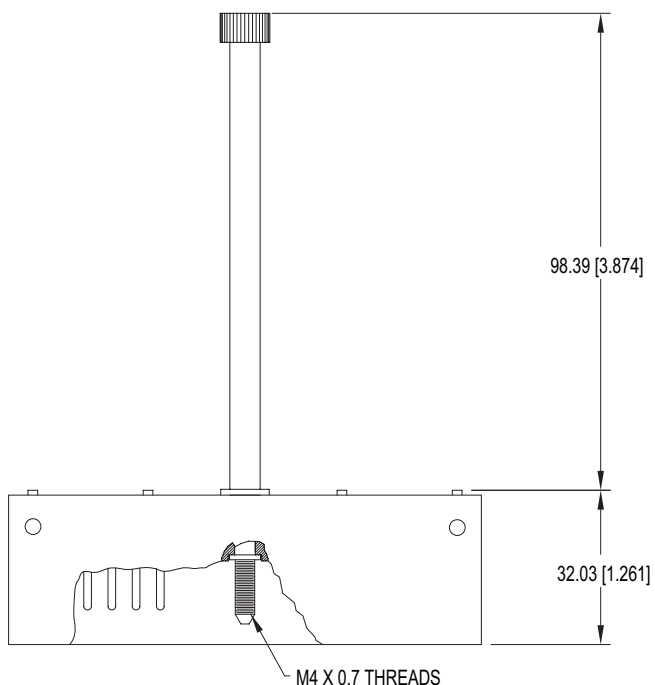

CABLE CONNECTORS
WITH ROTATING JACKSCREWS

EL

PART NUMBER: IP48M00ELO
with Long Rotating Jackscrew (Shown)

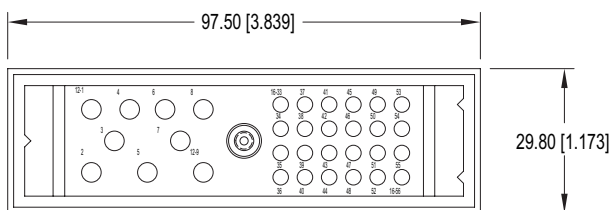
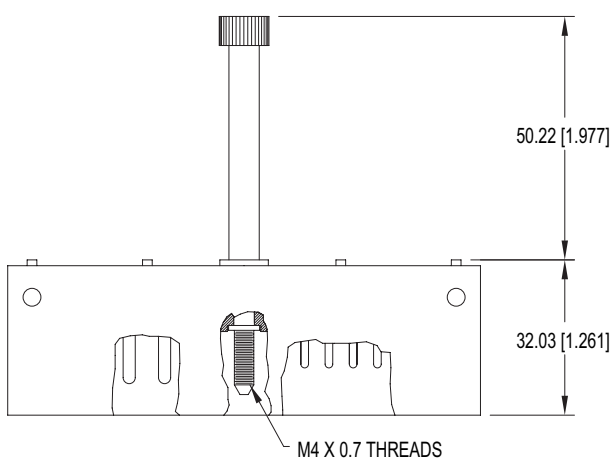

OTHER CONNECTOR VARIANTS ARE AVAILABLE WITH THE ROTATING JACKSCREW OPTION, SEE ORDERING INFORMATION ON PAGE 40.

FOR INFORMATION REGARDING SIZE 12, 16 AND 20 REMOVABLE CONTACTS, SEE REMOVABLE CONTACT SECTION, PAGES 41-48.

E

PART NUMBER: IP33W9M00E0
with Short Rotating Jackscrew (Shown)

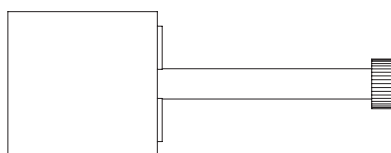

Positronic Industries

has the widest variety of

Power Connector Solutions

COMPACT POWER CONNECTOR

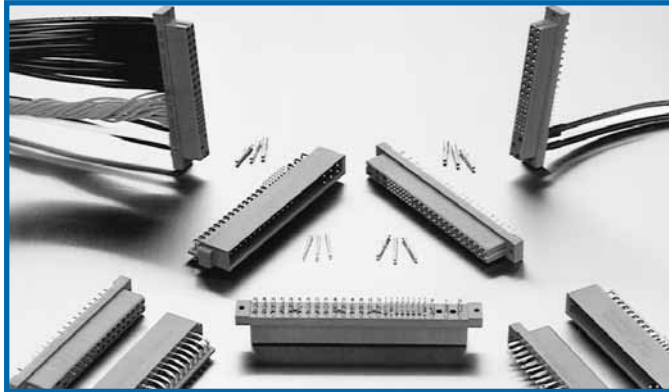

The Power interface for platforms utilizing Eurocard form factors including CompactPCI®, PICMG® 2.11 compliant. Multiple package sizes available.

INFINITY



Ideal for low, mid, and high power applications which demand outstanding blind mating capability.

POWER CONNECTION SYSTEMS

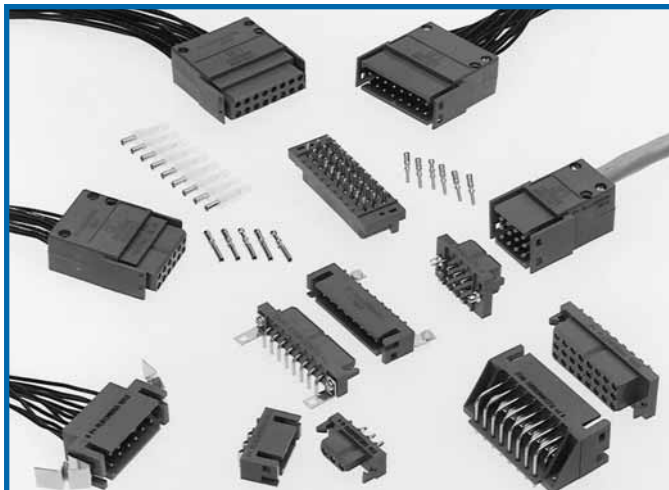

The industry standard for low and mid range power applications. Multiple package sizes available.

COMBO-D



Power, signal, coaxial, high voltage, and thermocouple contacts in an EMI/RFI shielded package.

FRONT RUNNER CIRCULAR



Power, signal, and thermocouple contacts in an environmental and/ or EMI/RFI shielded package.

EACH OF THESE SERIES HAVE ONE OR MORE OF THE FOLLOWING FEATURES:

- Hot swap capability
- A.C./ D.C. operation in a single connector
- Meets safety agency requirements
- Signal contacts for communication with host system
- Superior blind mating capability
- Cable and panel mount options
- Large surface area contact system
- Bi-Spring power press-fit terminations
- Single contact ratings up to 100 amperes
- Wide variety of variants & accessories

D-subminiature Products

Positronic Industries offers full line of D-subminiature connectors in a wide variety of contact variants and package sizes with press-fit, solder and cable terminations. All Positronic connector products provide quality, reliability, and flexibility.

DSUBMINATURE CONNECTORS

Standard and high density connectors with straight and right angle PCB mount, and cable terminations available. Multiple performance options for best economy/performance ratio.

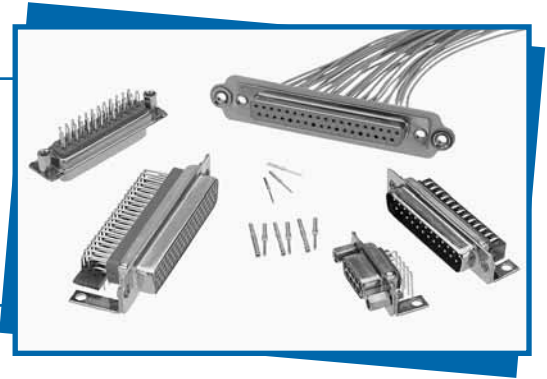

HIGH PERFORMANCE D-SUBMINIATURE CONNECTORS

Standard and high density connectors manufactured to MIL-PRF-24308, Class M; Goddard Space Flight Center S-311-P-4 and Goddard Space Flight Center S-311-P-10.

ENVIRONMENTAL-D CONNECTORS

Standard and high density connectors with environmental protection features to IP67. Straight and right angle, and cable terminations available.

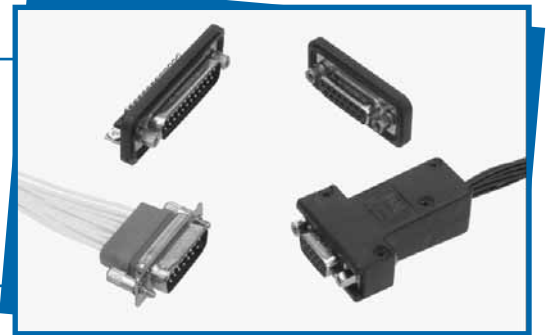

COMBO-D CONNECTORS

Connectors with signal, shielded, power, thermocouple or high voltage contacts in a single package. Power press-fit terminations now available.

DUAL PORT CONNECTORS

Right angle p.c. board mount connectors assembled stacked to maximize real estate; contact variants 9 through 62; available in standard density, high density, and mixed density.

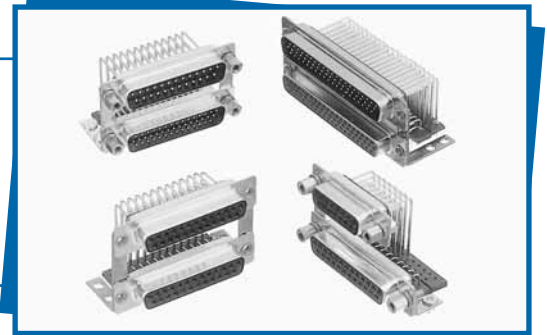

POSITRONIC PRODUCTS

Power

Contact Sizes: 0, 8, 12, 16, 20 and 22
Current Ratings: To 100 amperes
Terminations: Crimp, wire solder, straight solder, right angle (90°) solder, straight press-fit and right angle (90°) press-fit
Configurations: Multiple variants in a variety of package sizes
Compliance: PICMG 2.11, PICMG 3.0, VITA 41

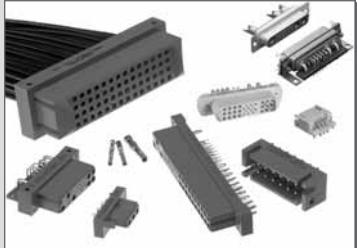

FEATURES: Hot swap capability • AC/DC operation in a single connector • Signal contacts for hardware management • Blind mating • Sequential mating • Large surface area contact mating system • Wide variety of accessories • Customer specified contact arrangements

D-subminiature

Contact Sizes: 8, 20 and 22
Current Ratings: To 40 amperes nominal
Terminations: Crimp, wire solder, straight solder, right angle (90°) solder and straight press-fit
Configurations: Multiple variants in both standard and high densities
Qualifications: MIL-DTL-24308, Goddard Space Flight S-311-P, SAE AS 39029, IP65, IP67



FEATURES: Three performance levels available: professional quality, military quality and space-flight quality provide multiple performance-to-cost choices • Options include thermocouple contacts, air coupling, environmentally sealed and dual port package including mixed density • Broad selection of accessories

Rectangular

Contact Sizes: 16, 20 and 22
Current Ratings: To 13 amperes
Terminations: Crimp, wire solder, straight solder and right angle (90°) solder
Configurations: Multiple variants in both standard and high densities
Qualifications: MIL-DTL-28748, SAE AS 39029, CCITT V.35



FEATURES: Two performance levels available: industrial quality and military quality provide two performance to cost choices • Large surface area contact mating system • A wide variety of accessories • Broad selection of contact variants and package sizes

Circular

Contact Sizes: 12, 16, 20 and 22
Current Ratings: To 25 amperes nominal
Terminations: Crimp, wire solder, straight solder and right angle (90°) solder
Configurations: Multiple variants
Qualifications: Environmental protection to IP67



FEATURES: Non-corrodible / lightweight composite construction • EMI/RFI shielded versions • Thermocouple contacts • Environmentally sealed versions • Rear insertion/front release of removable contacts • Two level sequential mating • Overmolding available on full assemblies

Cable

All Positronic connector products can be supplied as part of cable assemblies whose technical characteristics would reflect those of the connectors being used within the assembly.



FEATURES: Shorten the supply chain and reduce additional costs and delays by "cablizing" • Overmolding available • Shielded and environmentally sealed versions available • Power cables and access boxes which meet the SAE J2496 specification

Hermetic

Contact Sizes: 8, 12, 16, 20 and 22
Current Ratings: To 40 amperes nominal
Terminations: Feedthrough is standard; flying leads and board mount available upon request
Configurations: See D-subminiature and circular configurations above
Qualifications: Space-D32



FEATURES: Intended for use as an electrical feedthrough in high vacuum applications • Leakage rate: 5×10^{-9} mbar.l/s @ vacuum 1.5×10^{-5} atm • Signal, power, coax and high voltage versions available • Connectors can be mounted on flange assembly per customer specification



Positronic®

an **Amphenol** company

Divisional Headquarters

Positronic | Americas

1325 N Eldon Ave
Springfield MO 65803 USA

+1 800 641 4054
info@connectpositronic.com

Positronic | Europe

Z.I. d'Engachies
46, route d'Engachies
F-32020 Auch Cedex 9 France

+33 5 6263 4491
contact@connectpositronic.com

Positronic | Asia

3014A Ubi Rd 1 #07-01
Singapore 408703

+65 6842 1419
singapore@connectpositronic.com

Sales Offices

Positronic has local sales representation all over the world. To find the nearest sales office, please visit www.connectpositronic.com/sales

LOCATIONS