

**Driver LCO 25W 350/500/700/1050/1400mA 0-10V C ADV UNV**  
OUTDOOR advanced series

**Product description**

- \_ Constant current LED driver
- \_ Only for US applications
- \_ Dimmable via 0 ... 10 V interface
- \_ Dimming range 10 to 100 %
- \_ Class 2 power supply (not the 350 mA version)
- \_ FCC Part 15
- \_ Type HL rated for hazardous location
- \_ Dry and damp location
- \_ Max. output power 25 W
- \_ Up to 87 % efficiency
- \_ Nominal lifetime up to 100,000 h
- \_ 5 years guarantee (Conditions at [www.tridonic.com](http://www.tridonic.com))

**Housing properties**

- \_ Casing: polycarbonate, black
- \_ Potted style
- \_ Type of protection IP66

**Functions**

- \_ Over voltage protection
- \_ Short-circuit protection
- \_ No-load protection

**Typical applications**

- \_ For bollard, landscape and commercial fixtures

**Website**

<http://www.tridonic.us/28002143>



Spotlights



Downlights



Linear



Area



Floor | Wall



Free-standing



Street



Decorative

**Driver LCO 25W 350/500/700/1050/1400mA 0-10V C ADV UNV**  
OUTDOOR advanced series

The complete data sheet for this product is available in the Downloads section.

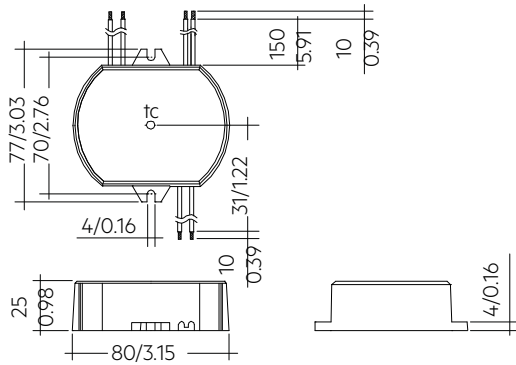

Dimensions in mm / inch

**Approval marks**



**Standards**

UL 8750, UL 1310, FCC PART 15, ANSI C62.41, ANSI C63.4, UL 1012, NEMA 4, CSA C22.2