

**Data sheet | Item number: 765-4504/100-000**

4-Port IO-Link Master Class B; EtherNet/IP; DC 24 V / 2.0 A; 4xM12 connection; SlimLine

[www.wago.com/765-4504/100-000](http://www.wago.com/765-4504/100-000)

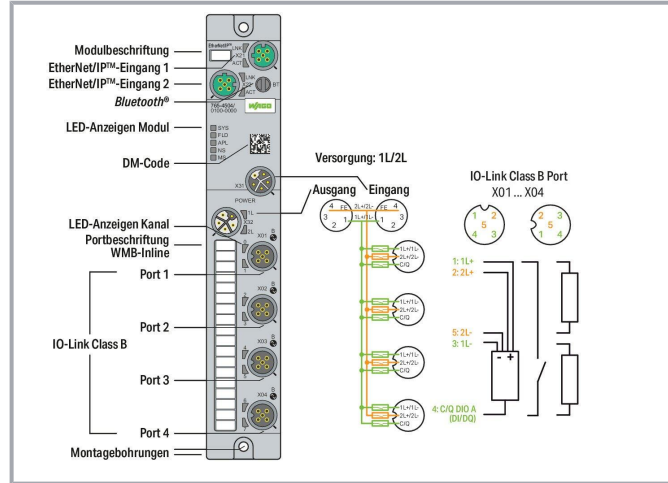

**Data**

**Technical data**

**Fieldbus**

Communication	EtherNet/IP™ BOOTP, DHCP, DLR
Connection technology: communication/fieldbus	2 x D-coded M12; 4-pole
Interface standard	10BASE-T/100BASE-TX; potential-free
Autonegotiation; autocrossover	yes

**Device functions**

Parameter	Input filter
-----------	--------------

Subject to changes. Please also observe the further product documentation!

WAGO GmbH & Co. KG  
 Hansastr. 27  
 32423 Minden  
 Phone: +49571 887-0 | Fax: +49571 887-169  
 Email: [info.de@wago.com](mailto:info.de@wago.com) | Web: [www.wago.com](http://www.wago.com)

Do you have any questions about our products?  
 We are always happy to take your call at +49 (571) 887-44222.



	Output current Temperature
Diagnostics	Undervoltage; Overcurrent; Overload; Overtemperature
Device functions	Bluetooth® OPC UA Server
Visualization	Web server Android/iOS app Webserver

## IO-Link master

IO-Link master classification	Class B; V1.1 specification
Port mode	IO-Link: autoconfig, manual, tool-based DI DO
Cycle time	400 µs (min.)
Operating mode	IO-Link master, DI or DO (adjustable for pin 4 per port); Supply voltage 2L (fixed for pin 2 per port)

## IO-Link ports

Number of digital inputs	4
Number of digital outputs	4
Connection technology: inputs/outputs	4 x A-coded M12; 5-pole
Signal type (voltage)	24 VDC
Input characteristic	High-side switching
Input filter	0.2 ... 20 ms
Input characteristic	Type 3, per IEC 61131-2
Output current (per channel)	2 A (typ.) for DO
Supply current per port	1L (Pin 1): 1 A for IO-Link; 4 A (max.) for DIO; 2L (Pin 2): 4 A (max.)

## Supply (module)

Connection technology: supply	2 x L-coded M12; 5-pole
Supply voltage	24 VDC (18 ... 31.2 V); 1L/2L
Current consumption (max.)	16000 mA
Current consumption (note)	per supply line; overload- and short-circuit-protected
Reverse voltage protection	Yes

## Physical data

Width	35 mm / 1.378 inches
-------	----------------------

Subject to changes. Please also observe the further product documentation!

WAGO GmbH & Co. KG  
Hansastr. 27  
32423 Minden  
Phone: +49571 887-0 | Fax: +49571 887-169  
Email: [info.de@wago.com](mailto:info.de@wago.com) | Web: [www.wago.com](http://www.wago.com)

Do you have any questions about our products?  
We are always happy to take your call at +49 (571) 887-44222.



Height	30 mm / 1.181 inches
Depth	210 mm / 8.268 inches

### Mechanical Data

Weight	380 g
Conformity marking	CE

### Environmental requirements

Ambient temperature (operation)	-25 ... +70 °C
Ambient temperature (storage)	-40 ... +80 °C
Protection type	IP67
Protection class	III per EN 61140, IEC 61140, VDE 0140-1
Operating altitude	0 ... 2000 m / 0 ... 6562 ft
Pollution degree	3 (EN 60664-1)
Overvoltage category	II (EN 60664-1)
Relative humidity (without condensation)	95 %
Vibration resistance	5g per IEC 60068-2-6
Shock resistance	Short-term: 50g/11 ms/half-sine per IEC 60068-2-27; Long-term: 30g/6 ms/half-sine per IEC 60068-2-29
EMC immunity to interference	per EN 61000-6-2
EMC emission of interference	per EN 61000-6-4

### Commercial data

ETIM 8.0	EC001601
ETIM 7.0	EC001601
PU (SPU)	1 pcs
Country of origin	DE
GTIN	4066966063226
Customs tariff number	85371098990

### Environmental Product Compliance

RoHS Compliance Status	Compliant, No Exemption
------------------------	-------------------------

### Required accessories

Tool	
Assembly tool	

Subject to changes. Please also observe the further product documentation!

Item no.: 206-701

Torque wrench M8 and M12; Assembly kit

[www.wago.com/206-701](http://www.wago.com/206-701)

### Marking accessories

#### Marking strip



Item no.: 2009-110

Marking strips; for Smart Printer; on reel; not stretchable; plain; snap-on type; white

[www.wago.com/2009-110](http://www.wago.com/2009-110)

#### Marker



Item no.: 2009-115

WMB-Inline; for Smart Printer; 1500 pieces on roll; stretchable 5 - 5.2 mm; plain; snap-on type; white

[www.wago.com/2009-115](http://www.wago.com/2009-115)

### Cover

#### Cover



Item no.: 756-8102

M12 protective cap; for unused sockets

[www.wago.com/756-8102](http://www.wago.com/756-8102)



Item no.: 756-8103

M12 protective cap; for unused plugs

[www.wago.com/756-8103](http://www.wago.com/756-8103)

### Optional accessories

#### Cables and pluggable connectors

##### Sensor/actuator cable



Item no.: 756-5402/050-010

Sensor/Actuator cable; M12A socket; straight; M12A plug; angled; 5-pole; Length: 1 m

[www.wago.com/756-5402/050-010](http://www.wago.com/756-5402/050-010)



Item no.: 756-5311/050-015

Sensor/Actuator cable; M12A plug; straight; 5-pole; Length: 1.5 m

[www.wago.com/756-5311/050-015](http://www.wago.com/756-5311/050-015)



Item no.: 756-5404/050-020

Sensor/Actuator cable; M12A socket; angled; M12A plug; angled; 5-pole; Length: 2 m

[www.wago.com/756-5404/050-020](http://www.wago.com/756-5404/050-020)



Item no.: 756-5404/050-010

Sensor/Actuator cable; M12A socket; angled; M12A plug; angled; 5-pole; Length: 1 m

[www.wago.com/756-5404/050-010](http://www.wago.com/756-5404/050-010)



Item no.: 756-5402/050-020

Sensor/Actuator cable; M12A socket; straight; M12A plug; angled; 5-pole; Length: 2 m

[www.wago.com/756-5402/050-020](http://www.wago.com/756-5402/050-020)



Item no.: 756-5312/050-015

Sensor/Actuator cable; M12A plug; angled; 5-pole; Length: 1.5 m

[www.wago.com/756-5312/050-015](http://www.wago.com/756-5312/050-015)

Subject to changes. Please also observe the further product documentation!

WAGO GmbH & Co. KG

Hansastr. 27











32423 Minden

Phone: +49571 887-0 | Fax: +49571 887-169

Email: [info.de@wago.com](mailto:info.de@wago.com) | Web: [www.wago.com](http://www.wago.com)

Do you have any questions about our products?

We are always happy to take your call at +49 (571) 887-44222.

	<b>Item no.: 756-5312/050-050</b> Sensor/Actuator cable; M12A plug; angled; 5-pole; Length: 5 m	<a href="http://www.wago.com/756-5312/050-050">www.wago.com/756-5312/050-050</a>
	<b>Item no.: 756-5312/050-100</b> Sensor/Actuator cable; M12A plug; angled; 5-pole; Length: 10 m	<a href="http://www.wago.com/756-5312/050-100">www.wago.com/756-5312/050-100</a>
	<b>Item no.: 756-5403/050-020</b> Sensor/Actuator cable; M12A socket; angled; M12A plug; straight; 5-pole; Length: 2 m	<a href="http://www.wago.com/756-5403/050-020">www.wago.com/756-5403/050-020</a>
	<b>Item no.: 756-5403/050-010</b> Sensor/Actuator cable; M12A socket; angled; M12A plug; straight; 5-pole; Length: 1 m	<a href="http://www.wago.com/756-5403/050-010">www.wago.com/756-5403/050-010</a>
	<b>Item no.: 756-5311/050-100</b> Sensor/Actuator cable; M12A plug; straight; 5-pole; Length: 10 m	<a href="http://www.wago.com/756-5311/050-100">www.wago.com/756-5311/050-100</a>
	<b>Item no.: 756-5311/050-050</b> Sensor/Actuator cable; M12A plug; straight; 5-pole; Length: 5 m	<a href="http://www.wago.com/756-5311/050-050">www.wago.com/756-5311/050-050</a>
	<b>Item no.: 756-5401/050-010</b> Sensor/Actuator cable; M12A socket; straight; M12A plug; straight; 5-pole; Length: 1 m	<a href="http://www.wago.com/756-5401/050-010">www.wago.com/756-5401/050-010</a>
	<b>Item no.: 756-5401/050-020</b> Sensor/Actuator cable; M12A socket; straight; M12A plug; straight; 5-pole; Length: 2 m	<a href="http://www.wago.com/756-5401/050-020">www.wago.com/756-5401/050-020</a>
<b>Configurable connectors</b>		
	<b>Item no.: 756-9202/050-000</b> Fitted pluggable connector; 5-pole; M12 plug, straight, A-coded; Spring	<a href="http://www.wago.com/756-9202/050-000">www.wago.com/756-9202/050-000</a>
	<b>Item no.: 756-9205/050-000</b> Fitted pluggable connector; 5-pole; M12 plug, right angle; Spring	<a href="http://www.wago.com/756-9205/050-000">www.wago.com/756-9205/050-000</a>
	<b>Item no.: 756-9711/050-000</b> Fitted pluggable connector; 5-pole, shielded; M12 socket, straight; IDC technology	<a href="http://www.wago.com/756-9711/050-000">www.wago.com/756-9711/050-000</a>
	<b>Item no.: 756-9701/050-000</b> Fitted pluggable connector; 5-pole, shielded; M12 plug, straight; IDC technology	<a href="http://www.wago.com/756-9701/050-000">www.wago.com/756-9701/050-000</a>
<b>Configurable shielded connectors</b>		

Subject to changes. Please also observe the further product documentation!



**Item no.: 756-9501/060-000**  
Fitted pluggable connector; 4-pole, shielded; M12 plug, straight, D-coded; Spring

[www.wago.com/756-9501/060-000](http://www.wago.com/756-9501/060-000)



**Item no.: 756-9501/040-000**  
Accessories; M12 plug, right angle; 4-pole

[www.wago.com/756-9501/040-000](http://www.wago.com/756-9501/040-000)

Power cable



**Item no.: 756-3501/050-075**  
Power cable; M12L socket; straight; 5-pole; Length: 7.5 m

[www.wago.com/756-3501/050-075](http://www.wago.com/756-3501/050-075)



**Item no.: 756-3501/050-100**  
Power cable; M12L socket; straight; 5-pole; Length: 10 m

[www.wago.com/756-3501/050-100](http://www.wago.com/756-3501/050-100)



**Item no.: 756-3501/050-150**  
Power cable; M12L socket; straight; 5-pole; Length: 15 m

[www.wago.com/756-3501/050-150](http://www.wago.com/756-3501/050-150)



**Item no.: 756-3501/050-050**  
Power cable; M12L socket; straight; 5-pole; Length: 5 m

[www.wago.com/756-3501/050-050](http://www.wago.com/756-3501/050-050)



**Item no.: 756-3502/050-050**  
Power cable; M12L socket; angled; 5-pole; Length: 5 m

[www.wago.com/756-3502/050-050](http://www.wago.com/756-3502/050-050)



**Item no.: 756-3502/050-150**  
Power cable; M12L socket; angled; 5-pole; Length: 15 m

[www.wago.com/756-3502/050-150](http://www.wago.com/756-3502/050-150)



**Item no.: 756-3502/050-075**  
Power cable; M12L socket; angled; 5-pole; Length: 7.5 m

[www.wago.com/756-3502/050-075](http://www.wago.com/756-3502/050-075)



**Item no.: 756-3502/050-100**  
Power cable; M12L socket; angled; 5-pole; Length: 10 m













[www.wago.com/756-3502/050-100](http://www.wago.com/756-3502/050-100)















**Item no.: 756-3503/050-075**  
Power cable; M12L plug; straight; 5-pole; Length: 7.5 m

[www.wago.com/756-3503/050-075](http://www.wago.com/756-3503/050-075)

Subject to changes. Please also observe the further product documentation!

	<b>Item no.: 756-3503/050-150</b> Power cable; M12L plug; straight; 5-pole; Length: 15 m	<a href="http://www.wago.com/756-3503/050-150">www.wago.com/756-3503/050-150</a>
	<b>Item no.: 756-3503/050-100</b> Power cable; M12L plug; straight; 5-pole; Length: 10 m	<a href="http://www.wago.com/756-3503/050-100">www.wago.com/756-3503/050-100</a>
	<b>Item no.: 756-3505/050-003</b> Power cable; M12L socket; straight; M12L plug; straight; 5-pole; Length: 0.3 m	<a href="http://www.wago.com/756-3505/050-003">www.wago.com/756-3505/050-003</a>
	<b>Item no.: 756-3505/050-005</b> Power cable; M12L socket; straight; M12L plug; straight; 5-pole; Length: 0.5 m	<a href="http://www.wago.com/756-3505/050-005">www.wago.com/756-3505/050-005</a>
	<b>Item no.: 756-3505/050-020</b> Power cable; M12L socket; straight; M12L plug; straight; 5-pole; Length: 2 m	<a href="http://www.wago.com/756-3505/050-020">www.wago.com/756-3505/050-020</a>
	<b>Item no.: 756-3505/050-010</b> Power cable; M12L socket; straight; M12L plug; straight; 5-pole; Length: 1 m	<a href="http://www.wago.com/756-3505/050-010">www.wago.com/756-3505/050-010</a>
	<b>Item no.: 756-3505/050-050</b> Power cable; M12L socket; straight; M12L plug; straight; 5-pole; Length: 5 m	<a href="http://www.wago.com/756-3505/050-050">www.wago.com/756-3505/050-050</a>
	<b>Item no.: 756-3505/050-075</b> Power cable; M12L socket; straight; M12L plug; straight; 5-pole; Length: 7.5 m	<a href="http://www.wago.com/756-3505/050-075">www.wago.com/756-3505/050-075</a>
	<b>Item no.: 756-3505/050-100</b> Power cable; M12L socket; straight; M12L plug; straight; 5-pole; Length: 10 m	<a href="http://www.wago.com/756-3505/050-100">www.wago.com/756-3505/050-100</a>
	<b>Item no.: 756-3506/050-100</b> Power cable; M12L socket; angled; M12L plug; angled; 5-pole; Length: 10 m	<a href="http://www.wago.com/756-3506/050-100">www.wago.com/756-3506/050-100</a>
	<b>Item no.: 756-3506/050-075</b> Power cable; M12L socket; angled; M12L plug; angled; 5-pole; Length: 7.5 m	<a href="http://www.wago.com/756-3506/050-075">www.wago.com/756-3506/050-075</a>
	<b>Item no.: 756-3506/050-150</b> Power cable; M12L socket; angled; M12L plug; angled; 5-pole; Length: 15 m	<a href="http://www.wago.com/756-3506/050-150">www.wago.com/756-3506/050-150</a>
	<b>Item no.: 756-3501/050-020</b> Power cable; M12L socket; straight; 5-pole; Length: 2 m	<a href="http://www.wago.com/756-3501/050-020">www.wago.com/756-3501/050-020</a>

Subject to changes. Please also observe the further product documentation!

	<b>Item no.: 756-3502/050-020</b> Power cable; M12L socket; angled; 5-pole; Length: 2 m	<a href="http://www.wago.com/756-3502/050-020">www.wago.com/756-3502/050-020</a>
	<b>Item no.: 756-3503/050-020</b> Power cable; M12L plug; straight; 5-pole; Length: 2 m	<a href="http://www.wago.com/756-3503/050-020">www.wago.com/756-3503/050-020</a>
	<b>Item no.: 756-3503/050-050</b> Power cable; M12L plug; straight; 5-pole; Length: 5 m	<a href="http://www.wago.com/756-3503/050-050">www.wago.com/756-3503/050-050</a>
	<b>Item no.: 756-3504/050-020</b> Power cable; M12L plug; angled; 5-pole; Length: 2 m	<a href="http://www.wago.com/756-3504/050-020">www.wago.com/756-3504/050-020</a>
	<b>Item no.: 756-3504/050-050</b> Power cable; M12L plug; angled; 5-pole; Length: 5 m	<a href="http://www.wago.com/756-3504/050-050">www.wago.com/756-3504/050-050</a>
	<b>Item no.: 756-3504/050-075</b> Power cable; M12L plug; angled; 5-pole; Length: 7.5 m	<a href="http://www.wago.com/756-3504/050-075">www.wago.com/756-3504/050-075</a>
	<b>Item no.: 756-3504/050-100</b> Power cable; M12L plug; angled; 5-pole; Length: 10 m	<a href="http://www.wago.com/756-3504/050-100">www.wago.com/756-3504/050-100</a>
	<b>Item no.: 756-3504/050-150</b> Power cable; M12L plug; angled; 5-pole; Length: 15 m	<a href="http://www.wago.com/756-3504/050-150">www.wago.com/756-3504/050-150</a>
	<b>Item no.: 756-3505/050-150</b> Power cable; M12L socket; straight; M12L plug; straight; 5-pole; Length: 15 m	<a href="http://www.wago.com/756-3505/050-150">www.wago.com/756-3505/050-150</a>
	<b>Item no.: 756-3506/050-003</b> Power cable; M12L socket; angled; M12L plug; angled; 5-pole; Length: 0.3 m	<a href="http://www.wago.com/756-3506/050-003">www.wago.com/756-3506/050-003</a>
	<b>Item no.: 756-3506/050-005</b> Power cable; M12L socket; angled; M12L plug; angled; 5-pole; Length: 0.5 m	<a href="http://www.wago.com/756-3506/050-005">www.wago.com/756-3506/050-005</a>
	<b>Item no.: 756-3506/050-020</b> Power cable; M12L socket; angled; M12L plug; angled; 5-pole; Length: 2 m	<a href="http://www.wago.com/756-3506/050-020">www.wago.com/756-3506/050-020</a>

Subject to changes. Please also observe the further product documentation!





**Item no.:** 756-3506/050-010  
Power cable; M12L socket; angled; M12L plug; angled; 5-pole; Length: 1 m

[www.wago.com/756-3506/050-010](http://www.wago.com/756-3506/050-010)



**Item no.:** 756-3506/050-050  
Power cable; M12L socket; angled; M12L plug; angled; 5-pole; Length: 5 m

[www.wago.com/756-3506/050-050](http://www.wago.com/756-3506/050-050)

Distribution connector



**Item no.:** 756-9301/050-000  
Accessories; 5-pole

[www.wago.com/756-9301/050-000](http://www.wago.com/756-9301/050-000)

ETHERNET/PROFINET cable



**Item no.:** 756-1202/060-200  
ETHERNET cable; M12D plug; angled; 4-pole; Length: 20 m

[www.wago.com/756-1202/060-200](http://www.wago.com/756-1202/060-200)



**Item no.:** 756-1201/060-100  
ETHERNET cable; M12D plug; straight; 4-pole; Length: 10 m

[www.wago.com/756-1201/060-100](http://www.wago.com/756-1201/060-100)



**Item no.:** 756-1201/060-050  
ETHERNET cable; M12D plug; straight; 4-pole; Length: 5 m

[www.wago.com/756-1201/060-050](http://www.wago.com/756-1201/060-050)



**Item no.:** 756-1203/060-050  
ETHERNET cable; M12D plug; straight; M12D plug; straight; 4-pole; Length: 5 m

[www.wago.com/756-1203/060-050](http://www.wago.com/756-1203/060-050)



**Item no.:** 756-1203/060-020  
ETHERNET cable; M12D plug; straight; M12D plug; straight; 4-pole; Length: 2 m

[www.wago.com/756-1203/060-020](http://www.wago.com/756-1203/060-020)



**Item no.:** 756-1202/060-020  
ETHERNET cable; M12D plug; angled; 4-pole; Length: 2 m

[www.wago.com/756-1202/060-020](http://www.wago.com/756-1202/060-020)



**Item no.:** 756-1201/060-200  
ETHERNET cable; M12D plug; straight; 4-pole; Length: 20 m











[www.wago.com/756-1201/060-200](http://www.wago.com/756-1201/060-200)



**Item no.:** 756-1204/060-050  
ETHERNET cable; M12D plug; angled; M12D plug; angled; 4-pole; Length: 5 m

[www.wago.com/756-1204/060-050](http://www.wago.com/756-1204/060-050)

Subject to changes. Please also observe the further product documentation!

	<b>Item no.: 756-1204/060-100</b> ETHERNET cable; M12D plug; angled; M12D plug; angled; 4-pole; Length: 10 m	<a href="http://www.wago.com/756-1204/060-100">www.wago.com/756-1204/060-100</a>
	<b>Item no.: 756-1204/060-200</b> ETHERNET cable; M12D plug; angled; M12D plug; angled; 4-pole; Length: 20 m	<a href="http://www.wago.com/756-1204/060-200">www.wago.com/756-1204/060-200</a>
	<b>Item no.: 756-1203/060-200</b> ETHERNET cable; M12D plug; straight; M12D plug; straight; 4-pole; Length: 20 m	<a href="http://www.wago.com/756-1203/060-200">www.wago.com/756-1203/060-200</a>
	<b>Item no.: 756-1203/060-100</b> ETHERNET cable; M12D plug; straight; M12D plug; straight; 4-pole; Length: 10 m	<a href="http://www.wago.com/756-1203/060-100">www.wago.com/756-1203/060-100</a>
	<b>Item no.: 756-1204/060-010</b> ETHERNET cable; M12D plug; angled; M12D plug; angled; 4-pole; Length: 1 m	<a href="http://www.wago.com/756-1204/060-010">www.wago.com/756-1204/060-010</a>
	<b>Item no.: 756-1204/060-030</b> ETHERNET cable; M12D plug; angled; M12D plug; angled; 4-pole; Length: 3 m	<a href="http://www.wago.com/756-1204/060-030">www.wago.com/756-1204/060-030</a>
	<b>Item no.: 756-1204/060-020</b> ETHERNET cable; M12D plug; angled; M12D plug; angled; 4-pole; Length: 2 m	<a href="http://www.wago.com/756-1204/060-020">www.wago.com/756-1204/060-020</a>
	<b>Item no.: 756-1202/060-050</b> ETHERNET cable; M12D plug; angled; 4-pole; Length: 5 m	<a href="http://www.wago.com/756-1202/060-050">www.wago.com/756-1202/060-050</a>
	<b>Item no.: 756-1202/060-100</b> ETHERNET cable; M12D plug; angled; 4-pole; Length: 10 m	<a href="http://www.wago.com/756-1202/060-100">www.wago.com/756-1202/060-100</a>
	<b>Item no.: 756-1201/060-020</b> ETHERNET cable; M12D plug; straight; 4-pole; Length: 2 m	<a href="http://www.wago.com/756-1201/060-020">www.wago.com/756-1201/060-020</a>

## Downloads Documentation

### Manual

Product Manual 4-Port IO-Link Master Class B; EtherNet/IP DC 24 V / 2.0 A; 4xM12 Connection; SlimLine	V 2.0.0 2022 Jul 19	pdf 8.6 MB	Download
--	------------------------	---------------	----------

Subject to changes. Please also observe the further product documentation!



## Instruction Leaflet

I/O System Field package insert	2021 Dec 15	pdf 1.1 MB	Download
---------------------------------	-------------	---------------	----------

## System Description

WAGO I/O System Field; General Product Information		pdf 1.0 MB	Download
--	--	---------------	----------

## Engineering-Software

### WAGO IO-Link Configurator

WAGO IO-Link Configurator	V5.1.1-6618 2022 Feb 16	ZIP 91.8 MB	Download
---------------------------	----------------------------	----------------	----------

WAGO IO-Link Configurator allows configuration, parameterization, operation and monitoring of WAGO IO-Link Masters in the WAGO I/O System 750 and WAGO I/O System Field, and especially of the WAGO IO-Link devices connected to them.

Additionally, WAGO IO-Link Configurator can be used for complete configuration and operation of all IO-Link devices of third-party manufacturers, as long as they comply with the IO-Link specification. A product's process data can be visualized graphically and stored in trend curves. Up to eight elements can be selected for visualization, and the data can be recorded for up to 24 hours.

Device description files for the IO-Link Masters (IOLM) or IO-Link Devices (IODD) can be used to integrate new devices into the tool at any time. Convenient access to the IO-Link user organization's IODDfinder is available for the IODDs. This allows automated, selective download of IODDs when integrating new IO-Link devices. An integrated IODD viewer allows detailed insight into the IODD device description.

WAGO IO-Link Configurator can be used either as a standalone program or integrated into engineering systems with a TCI interface and *WAGO-I/O-CHECK*.

IO-Link Configurator can also be used to integrate the IO-Link Master (750-657) of the WAGO I/O System 750 Series and to access all the configurator's functions. This is made possible by the WAGO I/O System 750 IO-Link Adapter, which can be retrofitted. The WAGO I/O System 750 IO-Link Adapter requires the current version of WAGO IO-Link Configurator and a current version of *WAGO-I/O-CHECK*.

In addition, the download file contains the device descriptions for the respective fieldbus systems of the WAGO I/O System Field modules. These are pre-installed in the Configurator setup.

The WAGO IO-Link Configurator license is assigned to the specific PC on which it is installed (a workstation license).

Register now and test our engineering software for 30 days at no cost.

## Runtime Software

### Firmware

0765-x5xx, Ethernet/IP IO-Field	V 04	zip	Download
WAGO_FW0765-x5xx_V01010021_IX04	2023 Feb 2	1.6 MB	

Subject to changes. Please also observe the further product documentation!

WAGO GmbH & Co. KG

Hansastr. 27

32423 Minden

Phone: +49571 887-0 | Fax: +49571 887-169

Email: [info.de@wago.com](mailto:info.de@wago.com) | Web: [www.wago.com](http://www.wago.com)

Do you have any questions about our products?

We are always happy to take your call at +49 (571) 887-44222.



## CAD/CAE-Data

### CAD data

2D/3D Models 765-4504/100-000	<a href="#">URL</a>	<a href="#">Download</a>
-------------------------------	---------------------	--------------------------

### CAE data

EPLAN Data Portal 765-4504/100-000	<a href="#">URL</a>	<a href="#">Download</a>
------------------------------------	---------------------	--------------------------

## Device Files

### Device Description File

750-915; EDS-Dateien for EthernetIP / Serie 750, 765 and 767	12 2021 Jul 9	zip 168.4 kB	<a href="#">Download</a>
--	------------------	-----------------	--------------------------

Gerätebeschreibungsdateien 765-45xx, 765-15xx, EtherNet/IP	V1_1_0_11	zip 75.8 kB	<a href="#">Download</a>
--	-----------	----------------	--------------------------

## Environmental Product Compliance

### Compliance Search

Environmental Product Compliance 765-4504/100-000 4-Port IO-Link Master Class B; EtherNet/IP; DC 24 V / 2.0 A; 4xM12 connection; SlimLine	<a href="#">URL</a>	<a href="#">Download</a>
---	---------------------	--------------------------

## Installation Notes

## Product family

**WAGO I/O System Field**  
[Show all products from the family](#)

Subject to changes. Please also observe the further product documentation!