

VIOLETTA-S

~15° spot beam

SPECIFICATION:

Dimensions	21.7 x 21.7 mm
Height	6.6 mm
Fastening	pin
ROHS compliant	yes ⓘ

MATERIALS:

Component	Type	Material	Colour	Finish
VIOLETTA-S	Single lens	Silicone	clear	gloss

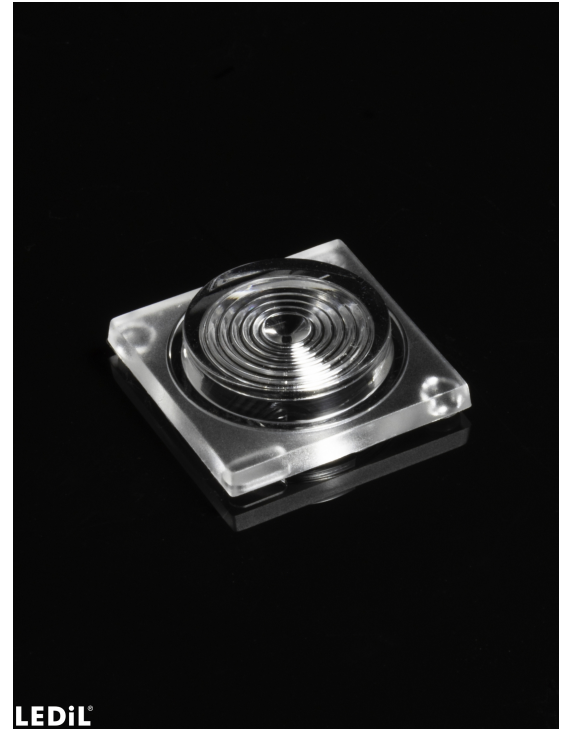

ORDERING INFORMATION:

Component	Qty in box	MOQ	MPQ	Box weight (kg)
F17822_VIOLETTA-S » Box size: 485 x 280 x 100 mm	1620	270	135	3.5

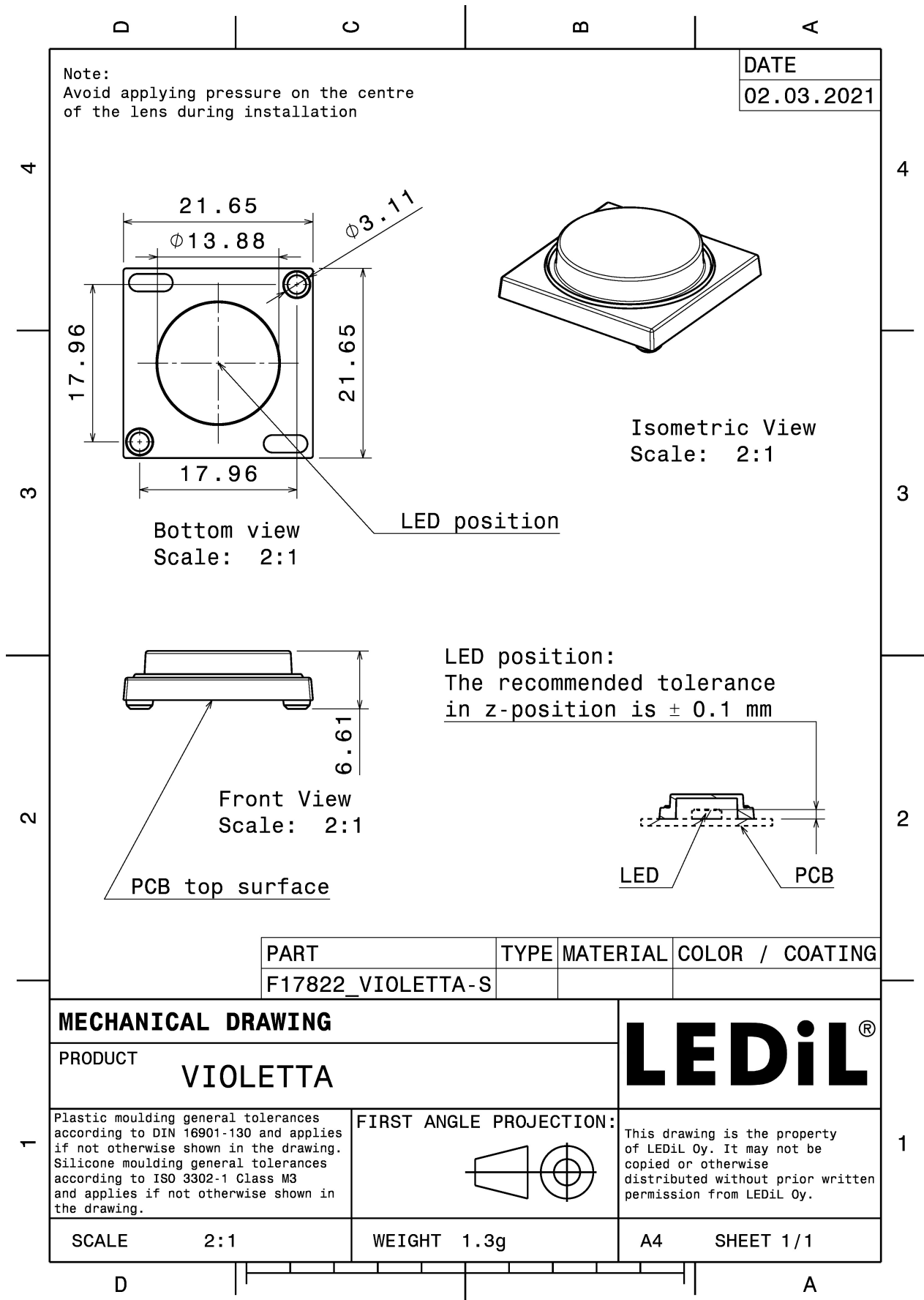

See also our general installation guide: www.ledil.com/installation_guide

OPTICAL RESULTS (MEASURED):



LED Bolb UV-C 6060 SMD
FWHM / FWTM 20.0° / 41.0°
Efficiency 56 %
LEDs/each optic 1
Light colour UV-C
Required components:

The UVC LED result tolerance is ± 10 %



LED CLH-N3S
FWHM / FWTM 19.0° / 45.0°
Efficiency 73 %
LEDs/each optic 1
Light colour UV-C
Required components:

The UVC LED result tolerance is ± 10 %



LED KL265-50V-SM-WD
FWHM / FWTM 15.0° / 32.0°
Efficiency 52 %
LEDs/each optic 1
Light colour UV-C
Required components:

The UVC LED result tolerance is ± 10 %



LED S3535-DR100-W272-P40
FWHM / FWTM 21.0° / 35.0°
Efficiency 72 %
LEDs/each optic 1
Light colour UV-C
Required components:

The UVC LED result tolerance is ± 10 %

OPTICAL RESULTS (MEASURED):



LED XFM-5050 2 Die
FWHM / FWTM 29.0° / 53.0°
Efficiency 56 %
LEDs/each optic 1
Light colour UV-C
Required components:

The UVC LED result tolerance is ± 10 %



LED XFM-5050 3 Die
FWHM / FWTM 24.0° / 55.0°
Efficiency 73 %
LEDs/each optic 1
Light colour UV-C
Required components:

The UVC LED result tolerance is ± 10 %



Opto Semiconductors

LED OSLOM UV 3636 (SU CULBN1.VC)
FWHM / FWTM 10.0° / 21.0°
Efficiency 67 %
LEDs/each optic 1
Light colour UV-C
Required components:

The UVC LED result tolerance is ± 10 %



Opto Semiconductors

LED OSLOM UV 3636 (SU CULDN1.VC)
FWHM / FWTM 16.0° / 35.0°
Efficiency 70 %
LEDs/each optic 1
Light colour UV-C
Required components:

The UVC LED result tolerance is ± 10 %

OPTICAL RESULTS (MEASURED):

OSRAM

Opto Semiconductors

LED OSLON UV 6060 (SU CZHEF1.VC)
FWHM / FWTM 20.0° / 35.0°
Efficiency 61 %
LEDs/each optic 1
Light colour UV-C

Required components:

The UVC LED result tolerance is ± 10 %

OSRAM

Opto Semiconductors

LED OSLON UV 6060 (SU CZHPF1.VC)
FWHM / FWTM 20.0° / 41.0°
Efficiency 66 %
LEDs/each optic 1
Light colour UV-C

Required components:

The UVC LED result tolerance is ± 10 %

SAMSUNG

LED UV351A
FWHM / FWTM 10.0° / 22.0°
Efficiency 64 %
LEDs/each optic 1
Light colour UV-C

Required components:

The UVC LED result tolerance is ± 10 %

SAMSUNG

LED UV351B
FWHM / FWTM 10.0° / 24.0°
Efficiency 64 %
LEDs/each optic 1
Light colour UV-C

Required components:

The UVC LED result tolerance is ± 10 %

OPTICAL RESULTS (MEASURED):

SAMSUNG

LED UV352B
FWHM / FWTM 10.0° / 22.0°
Efficiency 63 %
LEDs/each optic 1
Light colour UV-C
Required components:

The UVC LED result tolerance is ± 10 %

SAMSUNG

LED UV353B
FWHM / FWTM 14.0° / 31.0°
Efficiency 63 %
LEDs/each optic 1
Light colour UV-C
Required components:

The UVC LED result tolerance is ± 10 %

STANLEY

LED ZEUBE265 Series
FWHM / FWTM 22.0° / 45.0°
Efficiency 60 %
LEDs/each optic 1
Light colour UV-C
Required components:

The UVC LED result tolerance is ± 10 %

OPTICAL RESULTS (SIMULATED):

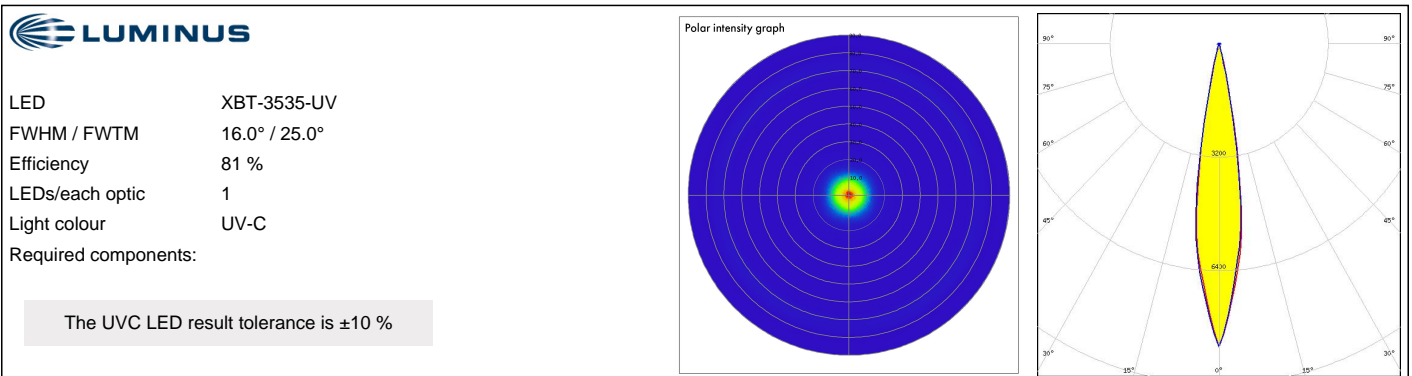
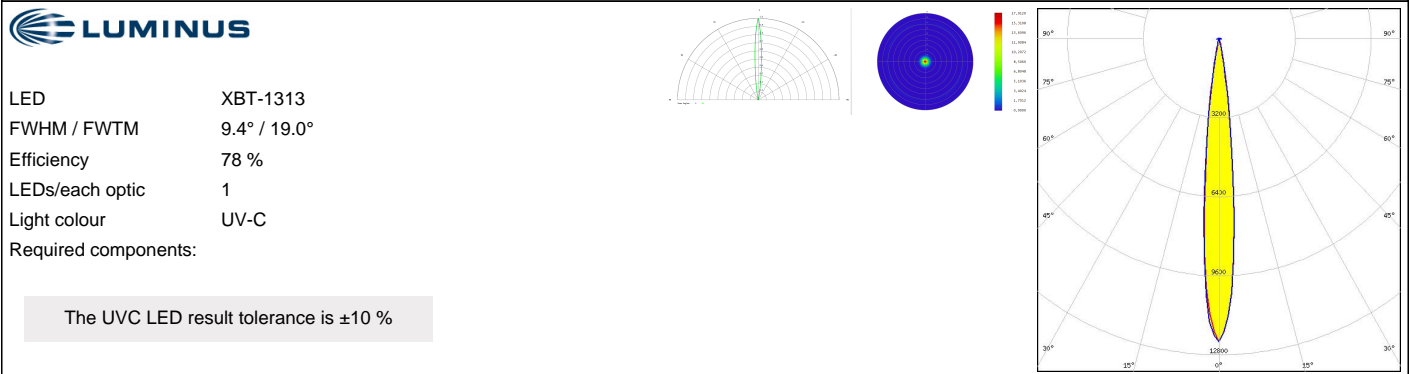
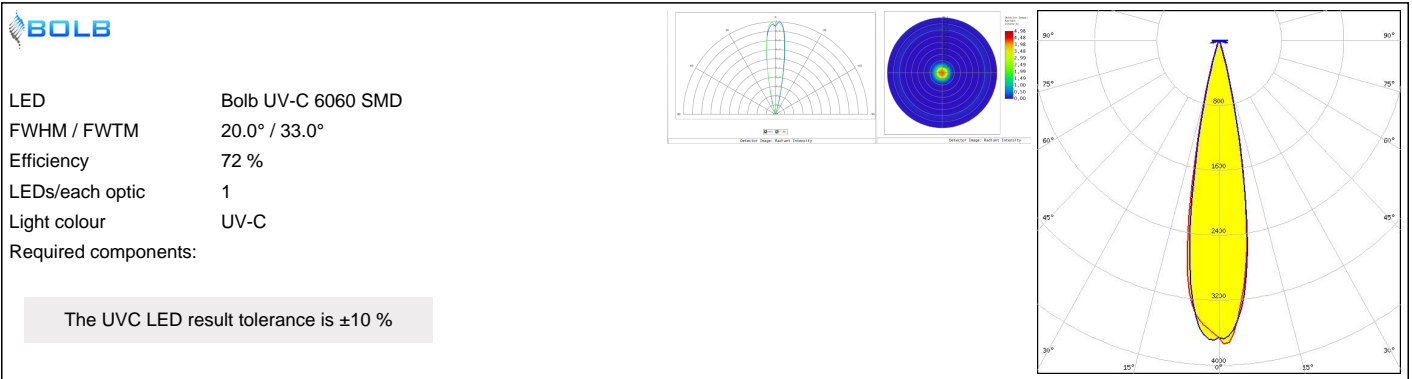

OPTICAL RESULTS (SIMULATED):

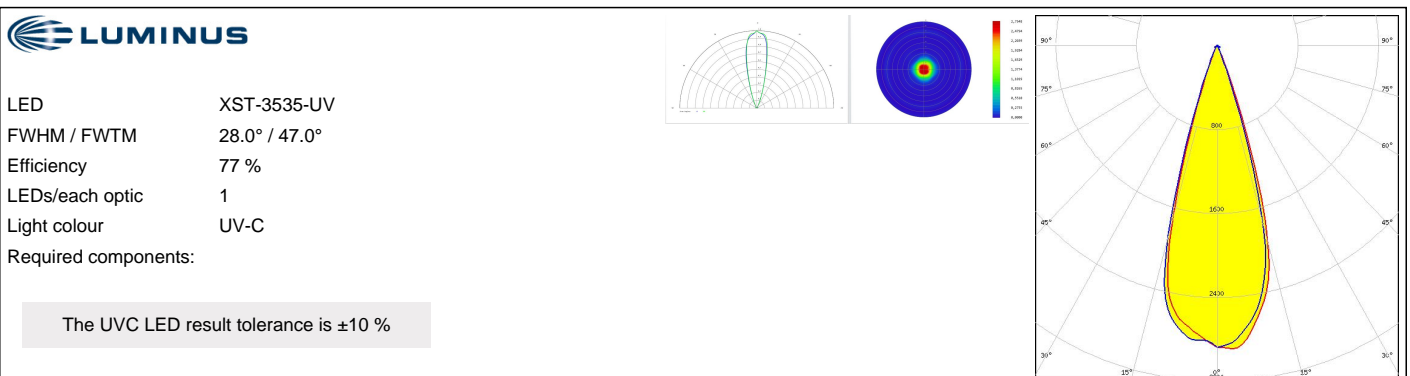
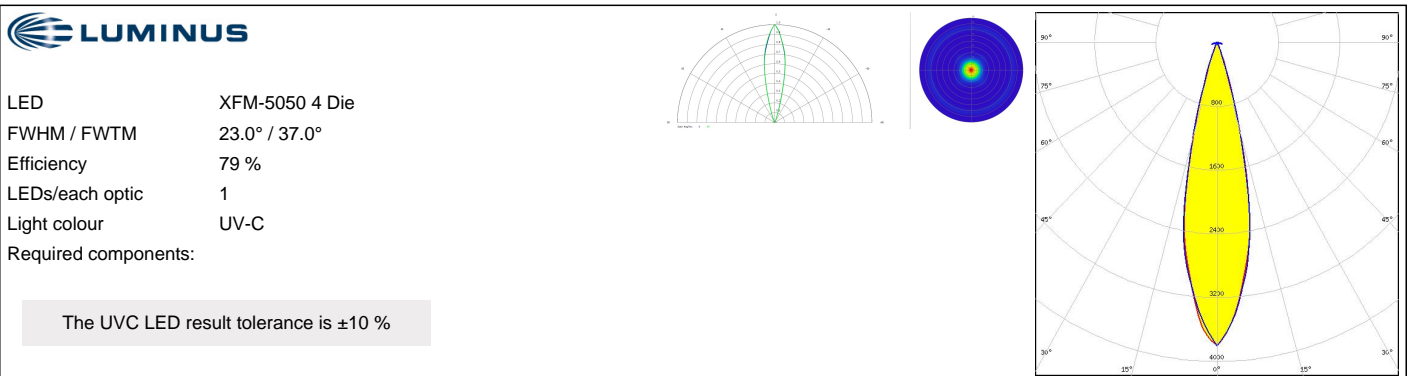
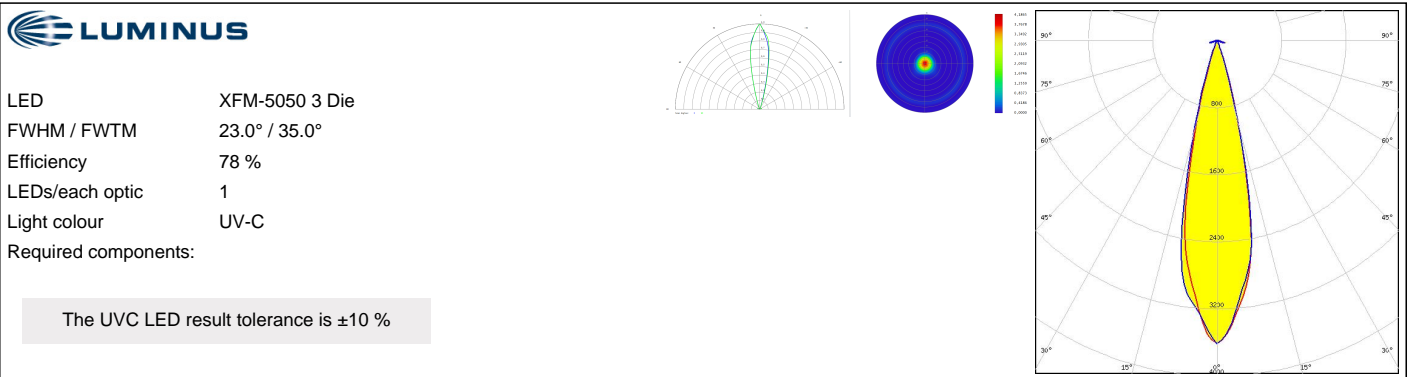
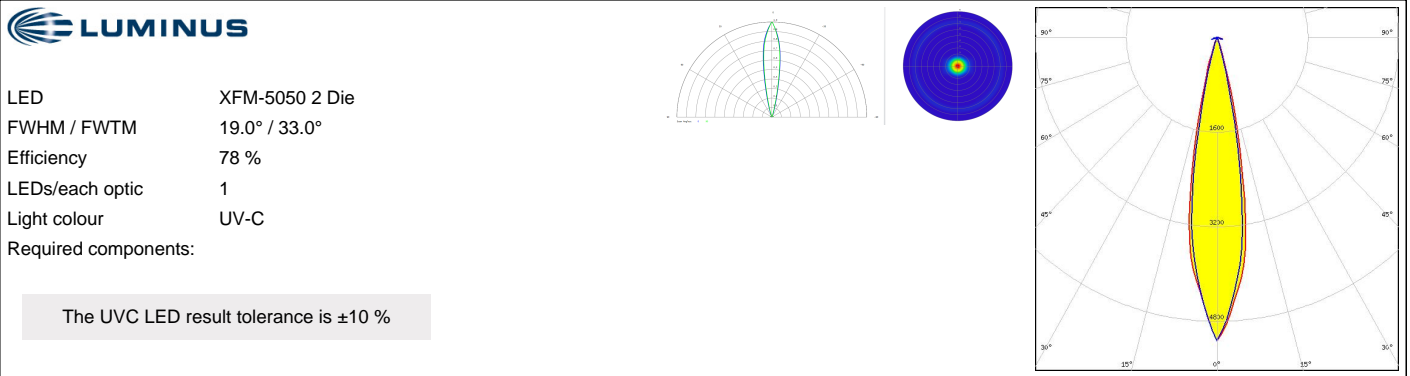

OPTICAL RESULTS (SIMULATED):

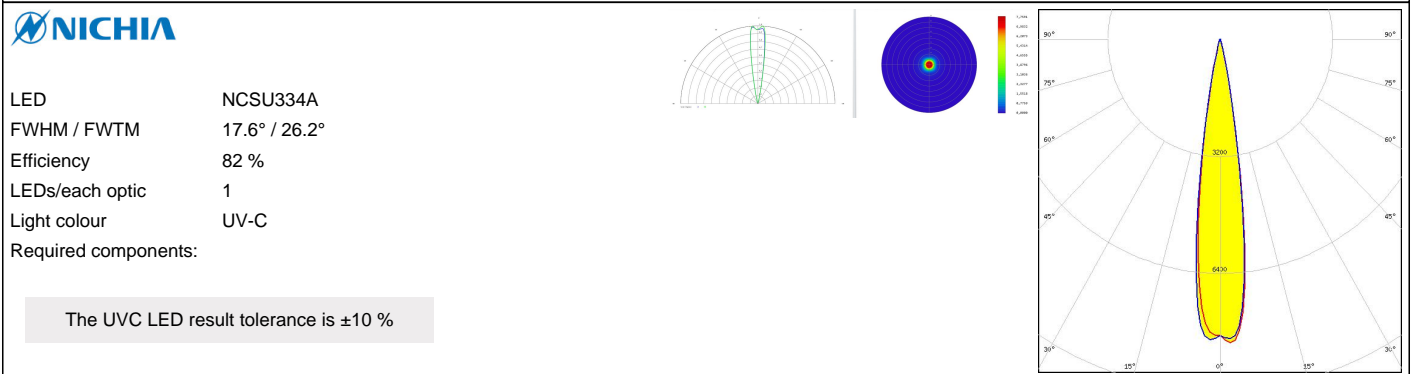
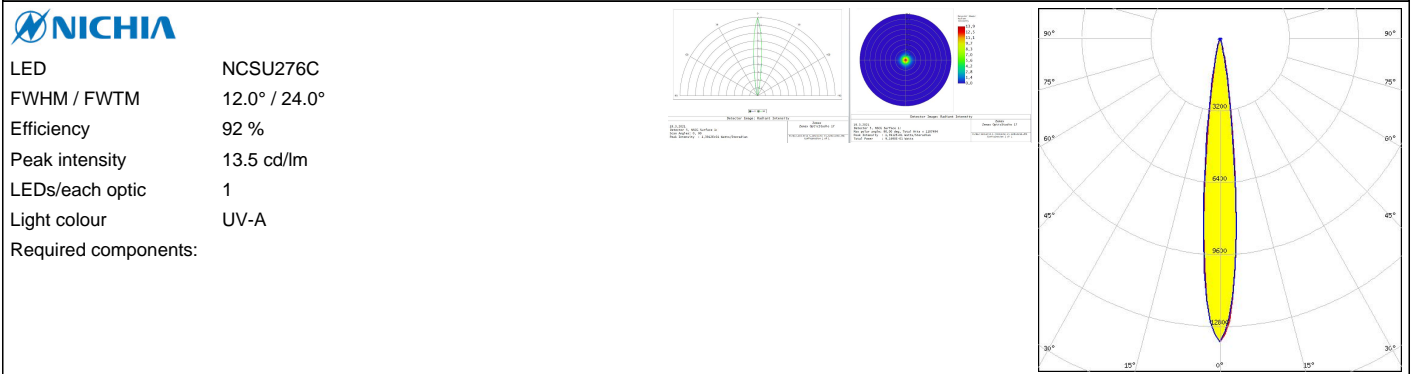
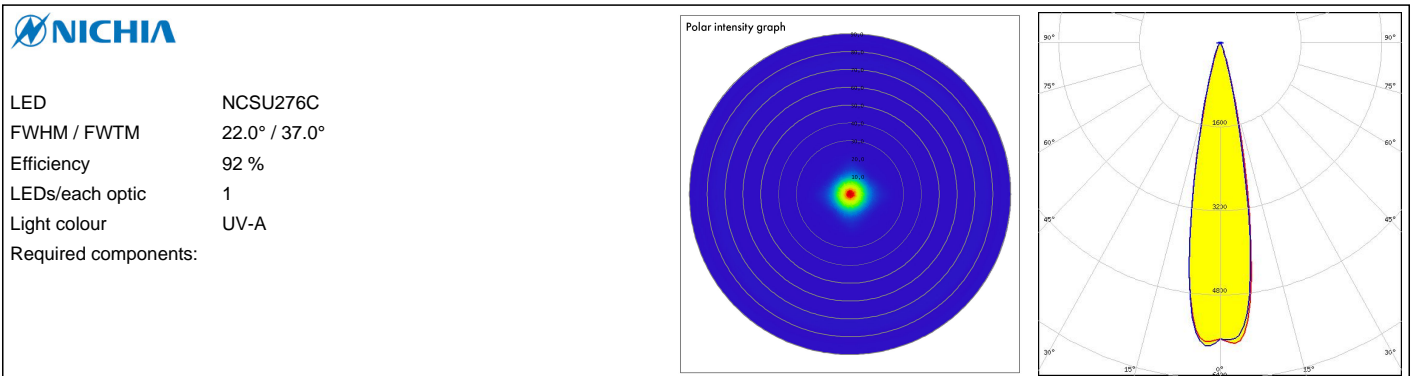
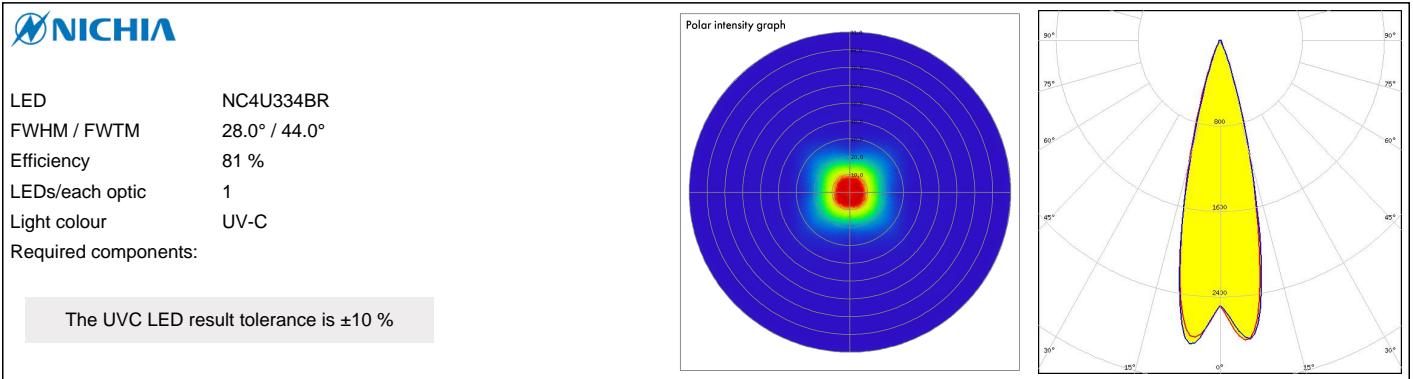

OPTICAL RESULTS (SIMULATED):

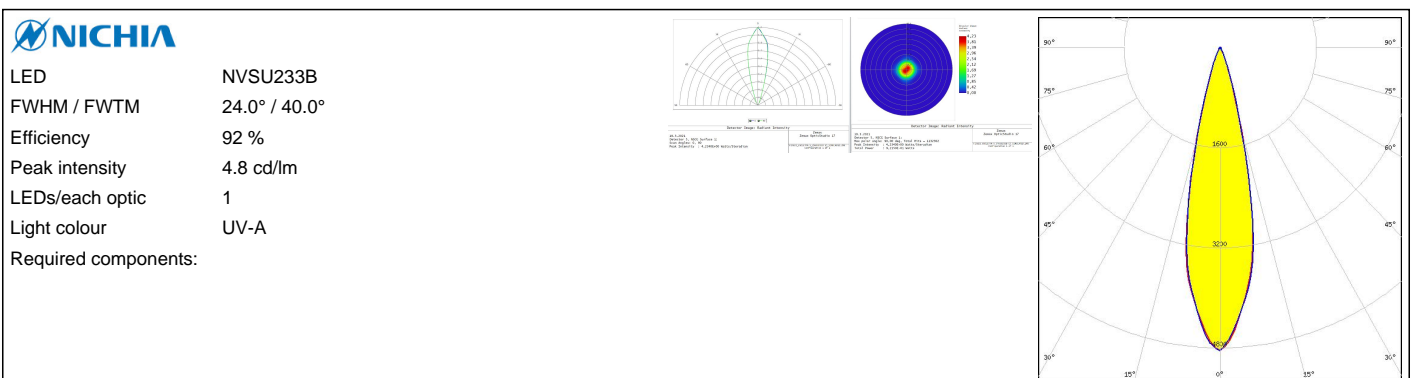
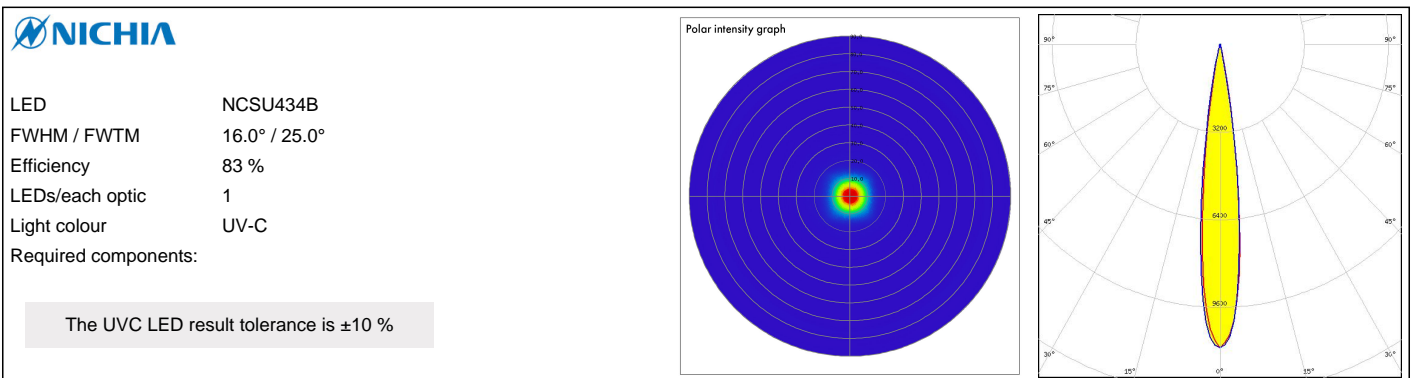
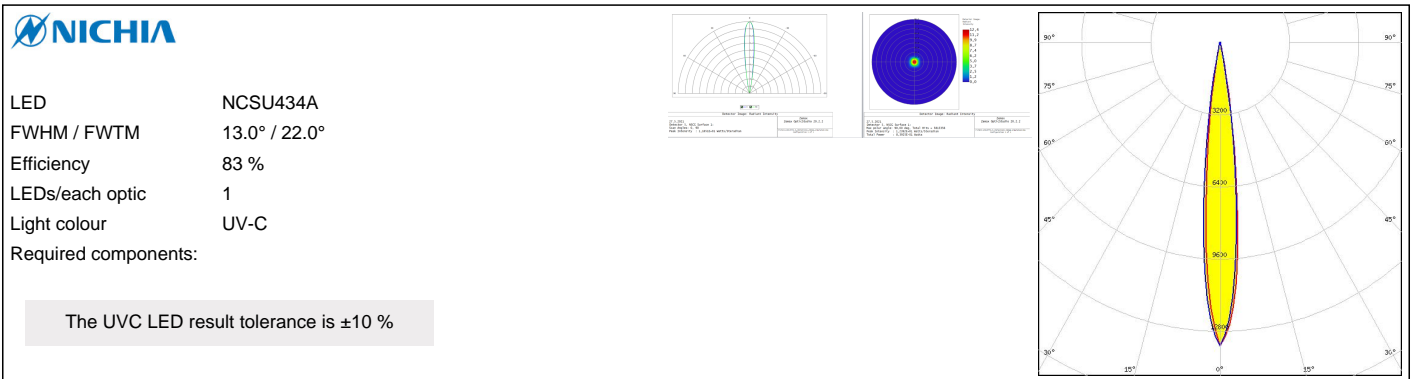
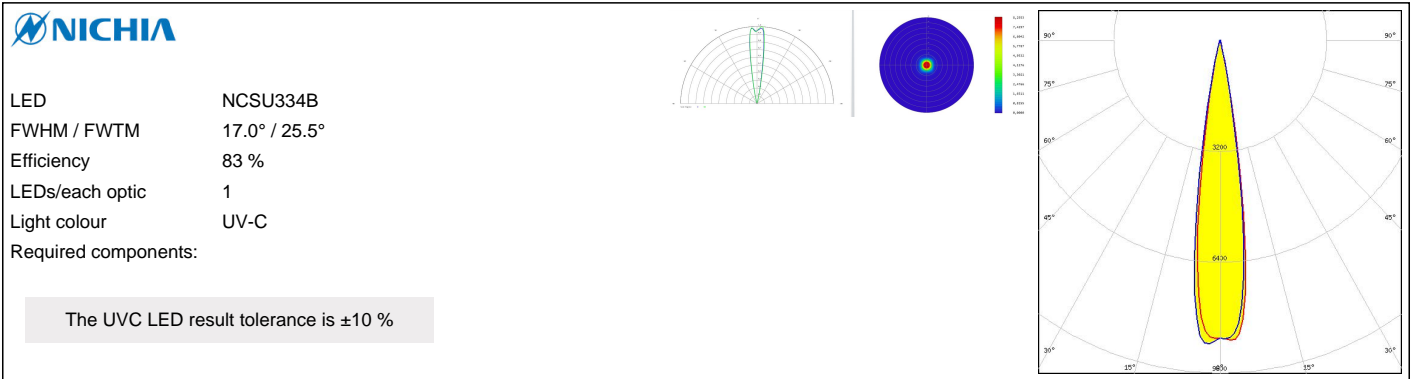

OPTICAL RESULTS (SIMULATED):

NICHIA

LED	NVSU233B-D4
FWHM / FWTM	37.0° / 74.0°
Efficiency	93 %
Peak intensity	2.1 cd/lm
LEDs/each optic	1
Light colour	UV-A
Required components:	

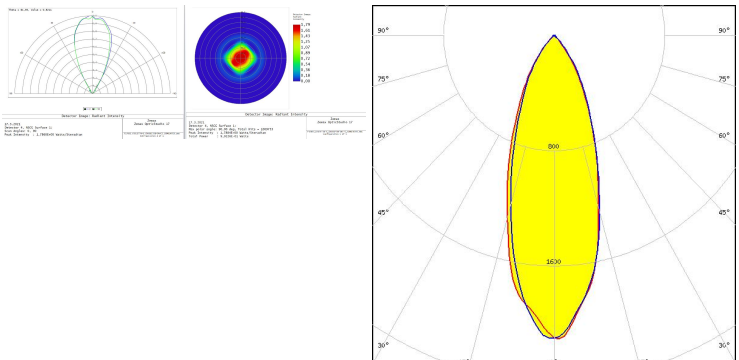

OSRAM
Opto Semiconductors

LED	OSLON UV 3636 (SU CULDN1.VC)
FWHM / FWTM	15.0° / 26.0°
Efficiency	82 %
LEDs/each optic	1
Light colour	UV-C
Required components:	

The UVC LED result tolerance is ± 10 %

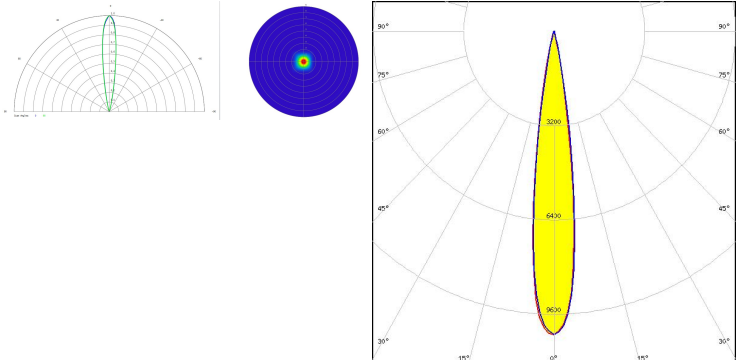

OSRAM
Opto Semiconductors

LED	OSLON UV 6060 (SU CZHEF1.VC)
FWHM / FWTM	17.0° / 28.0°
Efficiency	71 %
LEDs/each optic	1
Light colour	UV-C
Required components:	

The UVC LED result tolerance is ± 10 %

Polar intensity graph

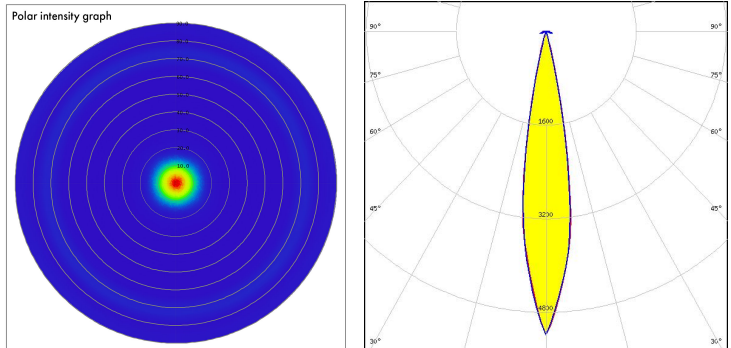

OSRAM
Opto Semiconductors

LED	OSLON UV 6060 (SU CZHPF1.VC)
FWHM / FWTM	16.0° / 27.0°
Efficiency	74 %
LEDs/each optic	1
Light colour	UV-C
Required components:	

The UVC LED result tolerance is ± 10 %

Polar intensity graph

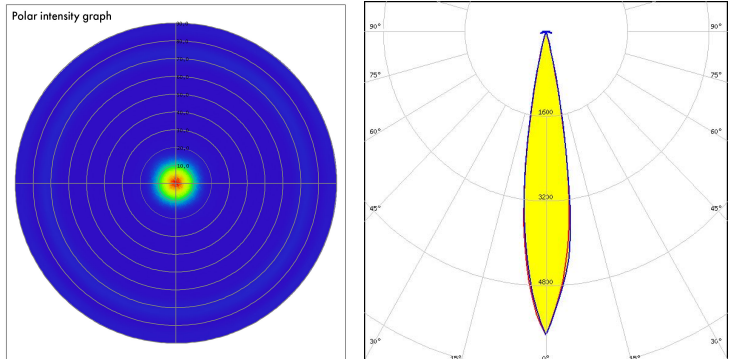

OPTICAL RESULTS (SIMULATED):

OSRAM
Opto Semiconductors

LED	OSTAR Projection Compact (KW.CSLNM1.TG)
FWHM / FWTM	18.0° / 27.0°
Efficiency	90 %
Peak intensity	7.9 cd/lm
LEDs/each optic	1
Light colour	White
Required components:	

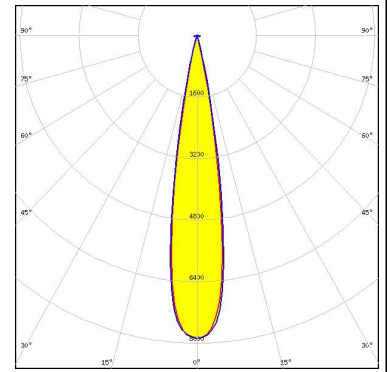

GENERAL INFORMATION:

NOTE: The typical beam angle will be changed by different color, chip size and chip position tolerance. The typical total beam angle is the full angle measured where the luminous intensity is half of the peak value.

MATERIALS:

As part of our continuous research and improvement processes, and to ensure the best possible quality and availability of our products, LEDiL reserves the right to change material grades without notice.

PRODUCT DATA USER AGREEMENT AND DISCLAIMER:

The measured data in the provided downloadable LEDiL Product Datasheets and Mechanical 2D-Drawings is rounded and provided as reference for planning. LEDiL Oy's optical specifications have been verified by conducting performance testing of the products in accordance with the company's quality system. The reported data are averaged results of multiple measurements with typical variation. LEDiL Oy reserves the right to without prior notification make changes and improvements to its products.

LEDiL Oy assumes neither warranty, nor guarantee nor any other liability of any kind for the contents and correctness of the provided data. The provided data has been generated with highest diligence but the provided data may in reality not represent the complete possible variation range of all intrinsic parameters. Therefore, in certain cases a deviation from the provided data could occur.

LEDiL Oy reserves the right to undertake technical changes of its products without further notification which could lead to changes in the provided data. LEDiL Oy assumes no liability of any kind for the possible deviation from any provided data or any other damage resulting from the usage of the provided data.

The user agrees to this disclaimer and user agreement with the download or usage of the provided files.

LEDiL Oy

Joensuunkatu 13
FI-24240 SALO
Finland

LEDiL Inc.

228 West Page Street
Suite D
Sycamore IL 60178
USA

Ledil Optics Technology (Shenzhen) Co., Ltd.

405 , Block B
Casic Motor Building
Shenzhen 518057
P.R.CHINA

Local sales and technical support

[www.ledil.com/
where_to_buy](http://www.ledil.com/where_to_buy)

Shipping locations

Salo, Finland
Hong Kong, China

Distribution Partners

[www.ledil.com/
where_to_buy](http://www.ledil.com/where_to_buy)