

Data sheet | Item number: 859-720

Optocoupler module; Nominal input voltage: 24 VDC; Output voltage range: 0 ... 24 VDC; Limiting continuous current: 6 A; 3-wire connection/low-side switching; Module width: 6 mm; gray

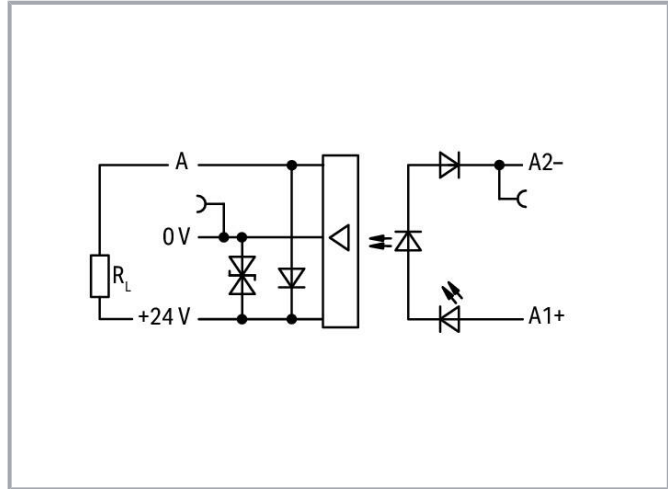

www.wago.com/859-720

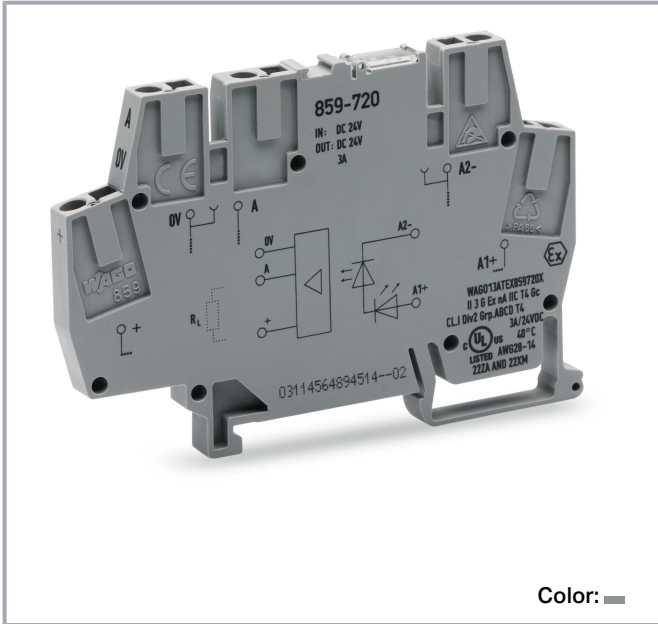

Color: ■

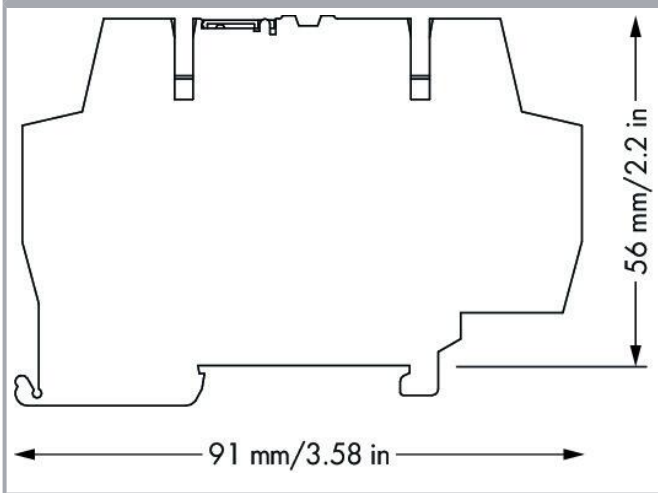

**Data
Notes**

Note

Subject to changes. Please also observe the further product documentation!

WAGO GmbH & Co. KG
Hansastr. 27
32423 Minden
Phone: +49571 887-0 | Fax: +49571 887-169
Email: info.de@wago.com | Web: www.wago.com

Do you have any questions about our products?
We are always happy to take your call at +49 (571) 887-44222.



Optocouplers and solid state relays are designed for use in signal processing networks, which are not supplied by the low-voltage power supply networks.

Technical data

Control Circuit

Nominal input voltage U_N	DC 24 V
Input voltage range (low level)	DC 0 ... 3 V
Input voltage range (high level)	DC 16 ... 30 V
Nominal input current at U_N	4 mA

Load circuit

Circuit type	3-wire connection Low-side switching
Limiting continuous current	3 A
Peak output current	20 A
Nominal output voltage	DC 24 V
Output voltage range	DC 10 ... 30 V
Voltage drop at output (max.)	≤ DC 0.5 V
Leakage current at rated voltage	≤ 25 μA
Turn-on time	≤ 30 μs
Turn-off time	≤ 75 μs
Rise time (t_{10-90})	16 μs
Drop-out time (t_{90-10})	20 μs
Switching frequency	≤ 2 kHz (< 0.5 A; ≤ 2 kHz / < 1 A; ≤ 1 kHz / < 2 A)

Signaling

Status indicator	Red LED
------------------	---------

Safety and protection

Rated voltage	300 V
Overvoltage category	II
Pollution degree	2

Subject to changes. Please also observe the further product documentation!



Dielectric strength (control/load circuit) (AC, 1 min)	2.5 kVrms
Insulation type (control/load circuit)	Basic insulation
Insulation type (adjacent devices)	Reinforced insulation (safe isolation)
Protection type	IP20; in connected state or when using 859-525 end plate

Connection data

Connection technology	CAGE CLAMP®
Solid conductor	0.08 ... 2.5 mm ² / 28 ... 14 AWG
Fine-stranded conductor	0.08 ... 2.5 mm ² / 28 ... 14 AWG
Fine-stranded conductor; with insulated ferrule	0.08 ... 1.5 mm ² / 28 ... 16 AWG
Strip length	5 ... 6 mm / 0.2 ... 0.24 inches

Physical data

Width	6 mm / 0.236 inches
Height	91 mm / 3.583 inches
Depth from upper-edge of DIN-rail	56 mm / 2.205 inches

Mechanical data

Mounting type	DIN-35 rail
Mounting position	horizontal (standing/lying); vertical

Material Data

Color	gray
Fire load	0.538 MJ
Weight	18.3 g

Environmental requirements

Ambient temperature (operation at U _N)	-25 ... +40 °C
Ambient temperature UL (operation at U _N)	-25 ... +40 °C
Ambient temperature (storage)	-40 ... +70 °C
Processing temperature	-25 ... +50 °C
Temperature range of connection cable	≥ (T _{ambient} + 20 K)
Relative humidity	5 ... 95 % (no condensation permissible)
Operating altitude (max.)	2000 m

Subject to changes. Please also observe the further product documentation!

Standards and specifications

Standards/specifications	EN 61010-2-201 EN 61000-6-2 EN 61000-6-3 EN 61373 UL 508
--------------------------	--

Commercial data



Product Group	6 (INTERFACE ELECTRONIC)
eCl@ss 10.0	27-26-15-03
eCl@ss 9.0	27-26-15-03
ETIM 8.0	EC001504
ETIM 7.0	EC001504
PU (SPU)	1 pcs
Packaging type	Box
Country of origin	DE
GTIN	4055143604802
Customs tariff number	85365005000

Environmental Product Compliance

RoHS Compliance Status	Compliant, No Exemption
------------------------	-------------------------

Approvals / Certificates

General approvals

Logo	Approval	Additional Approval Text	Certificate name
	CCC CNEX	CNCA-C23-01	2021312304000982 (Ex ec IIC T4 Gc)
	EAC Brjansker Zertifizierungsstelle	TP TC 020/2011	EAC_Certificate_RU_C- DE.AM02.B.00115_19



Declarations of conformity and manufacturer's declarations

Logo	Approval	Additional Approval Text	Certificate name
	EU-Declaration of Conformity WAGO GmbH & Co. KG	-	-







Subject to changes. Please also observe the further product documentation!



Approvals for hazardous areas

Logo	Approval	Additional Approval Text	Certificate name
	CCC CNEX	CNCA-C23-01	2021312304000982 (Ex ec IIC T4 Gc)
	UKEx WAGO GmbH & Co. KG	EN 60079-0	WAGO22UKEX007X_ec
	UL Underwriters Laboratories Inc. (HAZARDOUS LOCATIONS)	ANSI/ISA 12.12.01	E198726

Optional accessories

Ferrule			
Ferrule			
	Item no.: 216-223 Ferrule; Sleeve for 1 mm ² / AWG 18; insulated; electro-tin plated; red		www.wago.com/216-223
	Item no.: 216-222 Ferrule; Sleeve for 0.75 mm ² / 18 AWG; insulated; electro-tin plated; gray		www.wago.com/216-222
	Item no.: 216-221 Ferrule; Sleeve for 0.5 mm ² / 20 AWG; insulated; electro-tin plated; white		www.wago.com/216-221
	Item no.: 216-224 Ferrule; Sleeve for 1.5 mm ² / AWG 16; insulated; electro-tin plated; black		www.wago.com/216-224
	Item no.: 216-321 Ferrule; Sleeve for 0.25 mm ² / AWG 24; insulated; electro-tin plated; yellow		www.wago.com/216-321
	Item no.: 216-322 Ferrule; Sleeve for 0.34 mm ² / 22 AWG; insulated; electro-tin plated; light turquoise		www.wago.com/216-322
Jumpers			
Jumper			
	Item no.: 859-408 Jumper; for jumper slot; 8-way; insulated; light gray		www.wago.com/859-408

Subject to changes. Please also observe the further product documentation!



Item no.: 859-404/000-005
Jumper; for jumper slot; 4-way; insulated; red

www.wago.com/859-404/000-005



Item no.: 859-404/000-006
Jumper; for jumper slot; 4-way; insulated; blue

www.wago.com/859-404/000-006



Item no.: 859-405/000-005
Jumper; for jumper slot; 5-way; insulated; red

www.wago.com/859-405/000-005



Item no.: 859-405/000-029
Jumper; for jumper slot; 5-way; insulated; yellow

www.wago.com/859-405/000-029



Item no.: 859-405
Jumper; for jumper slot; 5-way; insulated; light gray

www.wago.com/859-405



Item no.: 859-404/000-029
Jumper; for jumper slot; 4-way; insulated; yellow

www.wago.com/859-404/000-029



Item no.: 859-406
Jumper; for jumper slot; 6-way; insulated; light gray

www.wago.com/859-406



Item no.: 859-405/000-006
Jumper; for jumper slot; 5-way; insulated; blue

www.wago.com/859-405/000-006



Item no.: 859-406/000-005
Jumper; for jumper slot; 6-way; insulated; red

www.wago.com/859-406/000-005



Item no.: 859-409/000-029
Jumper; for jumper slot; 9-way; insulated; yellow

www.wago.com/859-409/000-029



Item no.: 859-410/000-005
Jumper; for jumper slot; 10-way; insulated; red

www.wago.com/859-410/000-005

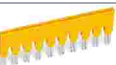

Item no.: 859-410/000-029
Jumper; for jumper slot; 10-way; insulated; yellow

www.wago.com/859-410/000-029



Item no.: 859-410
Jumper; for jumper slot; 10-way; insulated; light gray

www.wago.com/859-410

Subject to changes. Please also observe the further product documentation!

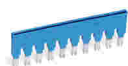

Item no.: 859-410/000-006
Jumper; for jumper slot; 10-way; insulated; blue

www.wago.com/859-410/000-006



Item no.: 859-403/000-005
Jumper; for jumper slot; 3-way; insulated; red

www.wago.com/859-403/000-005



Item no.: 859-402/000-029
Jumper; for jumper slot; 2-way; insulated; yellow

www.wago.com/859-402/000-029



Item no.: 859-403/000-029
Jumper; for jumper slot; 3-way; insulated; yellow

www.wago.com/859-403/000-029



Item no.: 859-403/000-006
Jumper; for jumper slot; 3-way; insulated; blue

www.wago.com/859-403/000-006



Item no.: 859-408/000-005
Jumper; for jumper slot; 8-way; insulated; red

www.wago.com/859-408/000-005



Item no.: 859-408/000-029
Jumper; for jumper slot; 8-way; insulated; yellow

www.wago.com/859-408/000-029



Item no.: 859-409
Jumper; for jumper slot; 9-way; insulated; light gray

www.wago.com/859-409



Item no.: 859-408/000-006
Jumper; for jumper slot; 8-way; insulated; blue

www.wago.com/859-408/000-006



Item no.: 859-403
Jumper; for jumper slot; 3-way; insulated; light gray

www.wago.com/859-403



Item no.: 859-409/000-005
Jumper; for jumper slot; 9-way; insulated; red

www.wago.com/859-409/000-005



Item no.: 859-404
Jumper; for jumper slot; 4-way; insulated; light gray

www.wago.com/859-404



Item no.: 859-409/000-006
Jumper; for jumper slot; 9-way; insulated; blue









www.wago.com/859-409/000-006



Item no.: 859-402/000-006
Jumper; for jumper slot; 2-way; insulated; blue

www.wago.com/859-402/000-006

Subject to changes. Please also observe the further product documentation!

	Item no.: 859-402 Jumper; for jumper slot; 2-way; insulated; light gray	www.wago.com/859-402
	Item no.: 859-402/000-005 Jumper; for jumper slot; 2-way; insulated; red	www.wago.com/859-402/000-005
	Item no.: 859-406/000-006 Jumper; for jumper slot; 6-way; insulated; blue	www.wago.com/859-406/000-006
	Item no.: 859-406/000-029 Jumper; for jumper slot; 6-way; insulated; signal yellow	www.wago.com/859-406/000-029
	Item no.: 859-407/000-006 Jumper; for jumper slot; 7-way; insulated; blue	www.wago.com/859-407/000-006
	Item no.: 859-407/000-005 Jumper; for jumper slot; 7-way; insulated; red	www.wago.com/859-407/000-005
	Item no.: 859-407/000-029 Jumper; for jumper slot; 7-way; insulated; yellow	www.wago.com/859-407/000-029
	Item no.: 859-407 Jumper; for jumper slot; 7-way; insulated; light gray	www.wago.com/859-407

Tool

Operating tool

	Item no.: 210-720 Operating tool; Blade: 3.5 x 0.5 mm; with a partially insulated shaft; multicoloured	www.wago.com/210-720
--	--	--

Marking accessories

Marking devices

	Item no.: 210-110 Fiber-tip pen	www.wago.com/210-110
--	---	--

Marker

	Item no.: 2009-145 Mini-WSB Inline; for Smart Printer; 1700 pieces on roll; stretchable 5 - 5.2 mm; plain; snap-on type; white	www.wago.com/2009-145
--	--	--

	Item no.: 248-501 Mini-WSB marking card; as card; not stretchable; plain; snap-on type; white	www.wago.com/248-501
--	---	--

Item no.: 248-504

Subject to changes. Please also observe the further product documentation!



Mini-WSB marking card; as card; MARKED; 21 ... 30 (10x); not stretchable; Horizontal marking; snap-on type; white www.wago.com/248-504



Item no.: 248-503
Mini-WSB marking card; as card; MARKED; 11 ... 20 (10x); not stretchable; Horizontal marking; snap-on type; white www.wago.com/248-503



Item no.: 248-506
Mini-WSB marking card; as card; MARKED; 41 ... 50 (10x); not stretchable; Horizontal marking; snap-on type; white www.wago.com/248-506



Item no.: 248-502
Mini-WSB marking card; as card; MARKED; 1 ... 10 (10x); not stretchable; Horizontal marking; snap-on type; white www.wago.com/248-502

End plate

Intermediate plate



Item no.: 859-525
End and intermediate plate; 1 mm thick; gray www.wago.com/859-525

Testing and measuring

Testing accessories



Item no.: 859-500
WAGO Test pin; 1 mm Ø; 30 V AC / 60 V DC; CAT0; 1 A; 10 mm uninsulated; Test lead for soldering up to 0,5mm² www.wago.com/859-500

Downloads

Documentation

Bid Text

859-720 docx - Datei	2019 Feb 20	docx 15.7 kB	Download
859-720 X81 - Datei	2019 Feb 19	xml 4.0 kB	Download

Instruction Leaflet

CCC Ex (Additional information) 859-***	2023 Apr 26	pdf 135.9 kB	Download
Relay modules, Optocoupler modules	V 2.0.0 2022 Jan 19	pdf 2.1 MB	Download

Additional Information

Disposal and Recycling Electrical and electronic equipment, Batteries, Packaging	V 1.1.0 2022 Aug 18	pdf 2.2 MB	Download
---	------------------------	---------------	----------

Subject to changes. Please also observe the further product documentation!

CAD/CAE-Data

CAD data

2D/3D Models 859-720	URL	Download
----------------------	---------------------	--------------------------

CAE data

EPLAN Data Portal 859-720	URL	Download
---------------------------	---------------------	--------------------------

ZUKEN Portal 859-720	URL	Download
----------------------	---------------------	--------------------------

WSCAD Universe 859-720	URL	Download
------------------------	---------------------	--------------------------

Environmental Product Compliance

Compliance Search

Environmental Product Compliance 859-720	URL	Download
--	---------------------	--------------------------

Optocoupler module; Nominal input voltage: 24 VDC; Output voltage range: 0 ... 24 VDC; Limiting continuous current: 6 A; 3-wire connection/low-side switching; Module width: 6 mm; gray

Installation Notes

Conductor termination

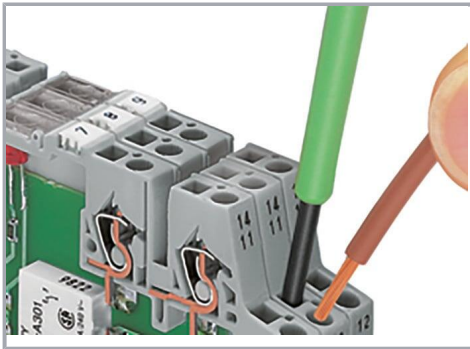

Conductor termination

Commoning

Subject to changes. Please also observe the further product documentation!

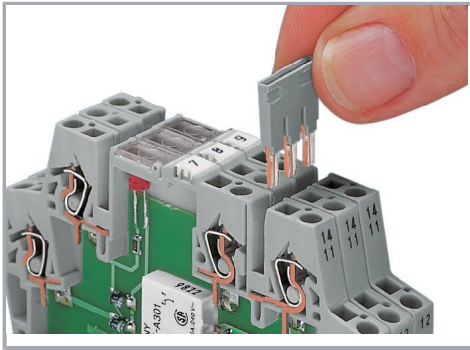

Easy commoning using adjacent jumpers

Marking



Marking via Mini-WSB Quick Marking System

Subject to changes. Please also observe the further product documentation!