

Multilayer Power Chip Inductors CPI0603 Series

FEATURES AND APPLICATIONS

Laird offers wide range inductance of multilayer power inductors. They are robust, small-sized structures. Low-loss magnetic material allows parts to perform at low DCR with high reliability under DC loading.

APPLICATIONS

- Mainly for DC-DC converters and power modules
- Suitable for DVD , DSC , PND , PC , NB
- Cellular phones

FEATURES

- Small size
- The monolithic construction performs high reliability
- Allow for higher mounting density
- Low DC resistance

Part Numbering

CPI	0603	J	4R7	R	-10
Product Series Code	Size Code	Rated Current Code	Inductance Value Code	Packing Code R-Tape&Reel	Additional Description
		A ≤ 100mA B=200mA C=300mA D=400mA E=500mA F=600mA G=700mA H=800mA I=900mA J=1000mA	R47=0.47uH 1R0=1.0uH 4R7=4.7uH		-10=Lead Free Standard Catalog Part

Notes

Standard testing conditions , unless otherwise specified

- Temperature: 18 °C to 28 °C
- Humidity: 40% to 85% (RH)
- L、 Q、 SRF : Agilent E4991A+ Agilent 16197A
- Operating Temperature: -40 °C to +125 °C (Including self-heating)
- Storage Temperature: -10 °C to +40 °C
- Products should be used within 12 months, from the time of delivery
- Cosmetic specification refer to WI-QA-124

1.SPECIFICATION

Part Number	L (uH)	Tolerance	L Test Fre (MHz)	Test Voltage	DCR Max (Ω)	Rated current (mA)	SRF (MHz)
CPI0603JR47R-10	0.47	20%	1	100mV	0.14	1200	70
CPI0603J1R0R-10	1.0	20%	1	100mV	0.25	1000	60
CPI0603G2R2R-10	2.2	20%	1	100mV	0.38	750	50
CPI0603A8R2R-10	8.2	20%	1	100mV	0.52	110	40
CPI0603A100R-10	10.0	20%	1	100mV	0.52	110	30

2.DIMENSIONS

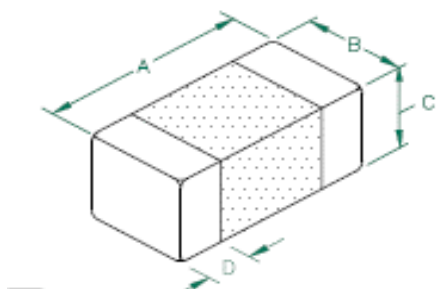

A	1.60±0.15
B	0.8±0.15
C	0.8±0.15
D	0.35±0.25

3. MATERIAL LIST

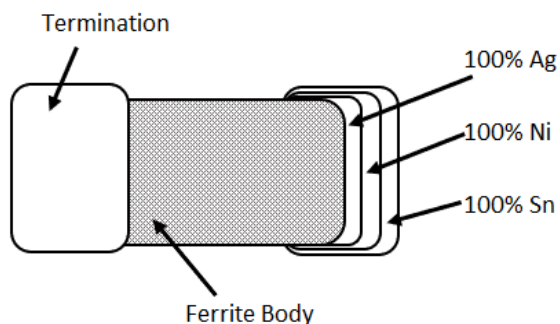

4.CURVES

Inductance-Frequency Characteristics (Typ.)

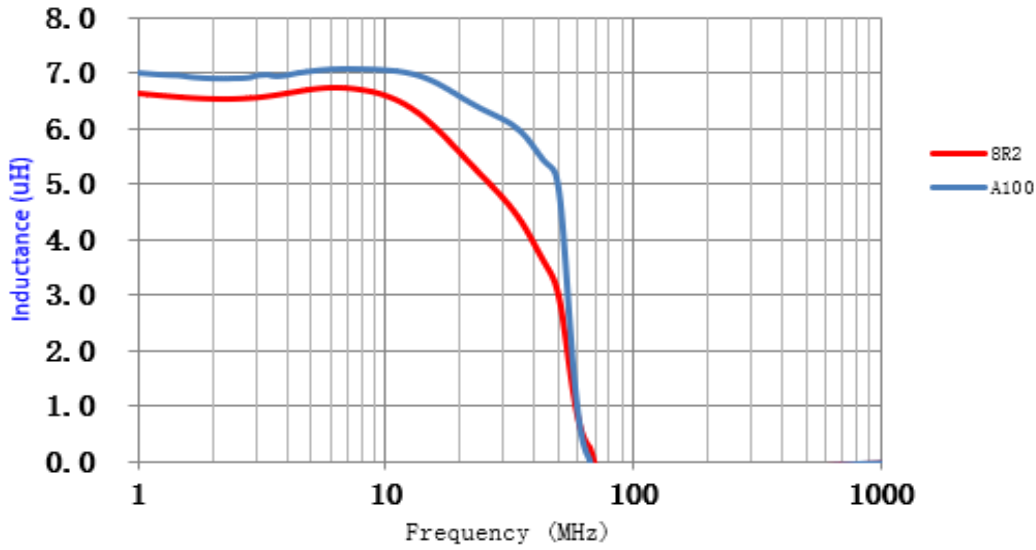

Inductance-Current Characteristics (Typ.)

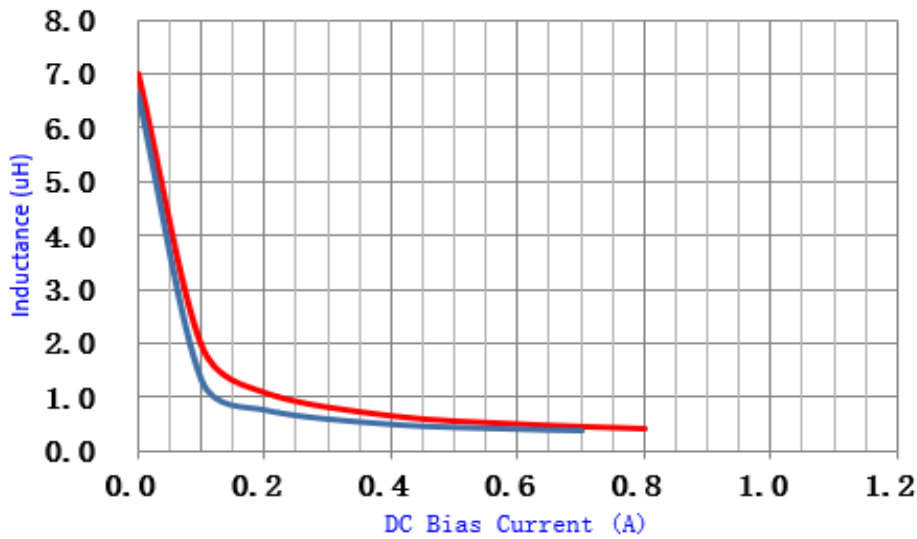

5. SOLDERING

Typical RoHS Reflow Profile

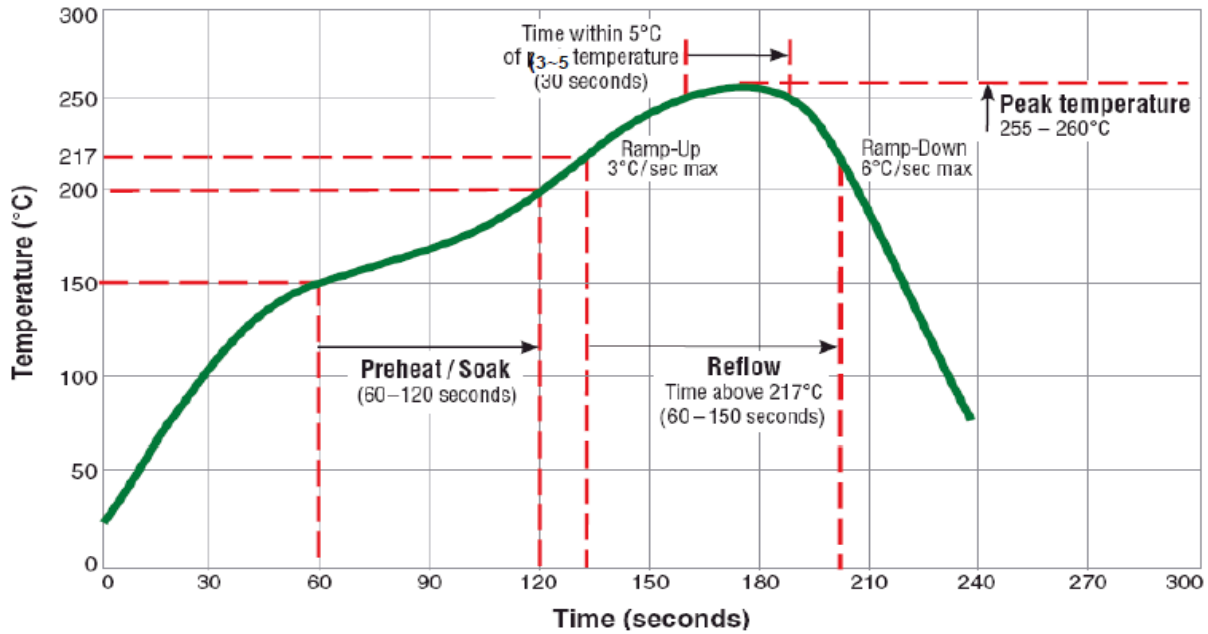

6. PACKAGING

Packaging Style and Quantity

Laird Part Number	Packaging Type	Reel Quantity	Inner box Quantity
CPI0603 Series	Tape & Reel	4000	20000

Taping Condition (Typ)

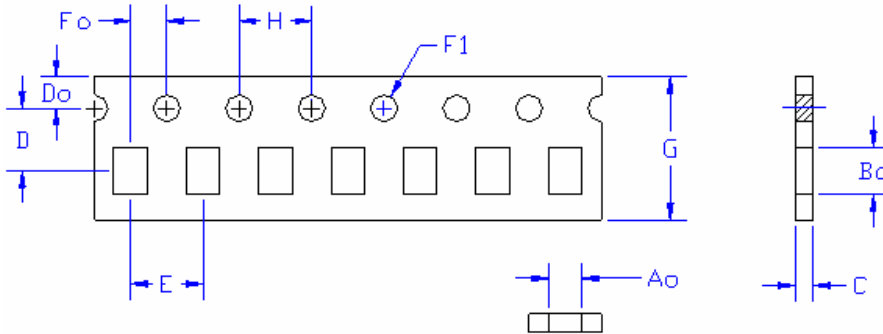

Ao	Bo	C	D	Do
1.45	2.25	1.5	3.5	1.75
E	Fo	F1	G	H
4	2	1.5	8	4

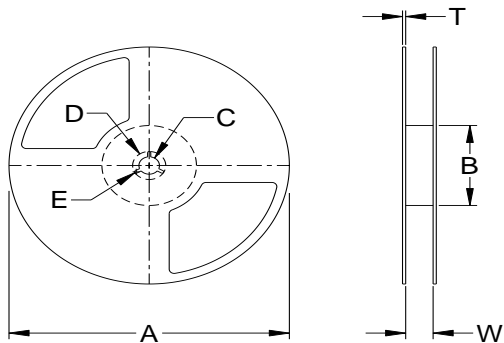

Reel Specifications (Typ)	
A	178
B	60
C	13
D	21
E	2
W	10
T	2

Tape Strength

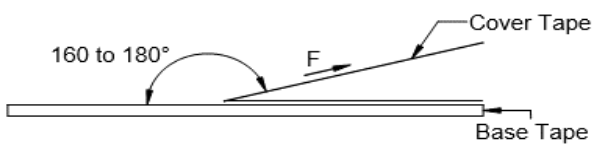

Tape Width	Peeling Force
8mm	0.2N to 1.2N

7.RELIABILITY

No	Stress	Reference	Additional Requirements
1	High Temperature Exposure (Storage)	MIL-STD-202 Method 108	85±2°C, 168+24hours Inductance change rate: within ±30%
2	Temperature Cycling	JESD22 Method JA-104	-40°C~+85°C, 100cycles Inductance change rate: within ±30%
3	Operational Life	MIL-PRF-27	85°C(Including self-heating), 168hrs, rated current applied(as the part drawing). Inductance change rate: within ±30%
4	External Visual	MIL-STD-883 Method 2009	Inspect device construction, marking and workmanship. Electrical Test not required.
5	Physical Dimension	JESD22 Method JB-100	Verify physical dimensions to the applicable device detail specification. Note: User(s) and Suppliers spec. Electrical Test not required.
6	Vibration	MIL-STD-202 Method 204	10~55Hz,1.5mm,2 hours in each 3mutually perpendicular directions,(total of 6 hours)
7	Resistance to Soldering Heat	MIL-STD-202 Method 210	1. Max. 260±5°C,10±1s, 2 times 2.Solder Composition: Sn/3Ag/0.5Cu
8	Solderability	J-STD-002	245±5°C, 5±1sec, Solder: Sn/3.0Ag/0.5Cu
9	Electrical Characterization	User Spec.	Parametrically test per lot and sample size requirements, summary to show Min, Max, Mean and Standard deviation at room as well as Min and Max Operating temperatures.
10	Board Flex	AEC-Q200-005	2mm(min), Dwell:30±1 sec.
11	Terminal Strength	AEC-Q200-006	Force:≥2.94N, Dwell:5+1 sec, X, Y direct