

Schematic for the NCP170AMX330GEVB Evaluation Board

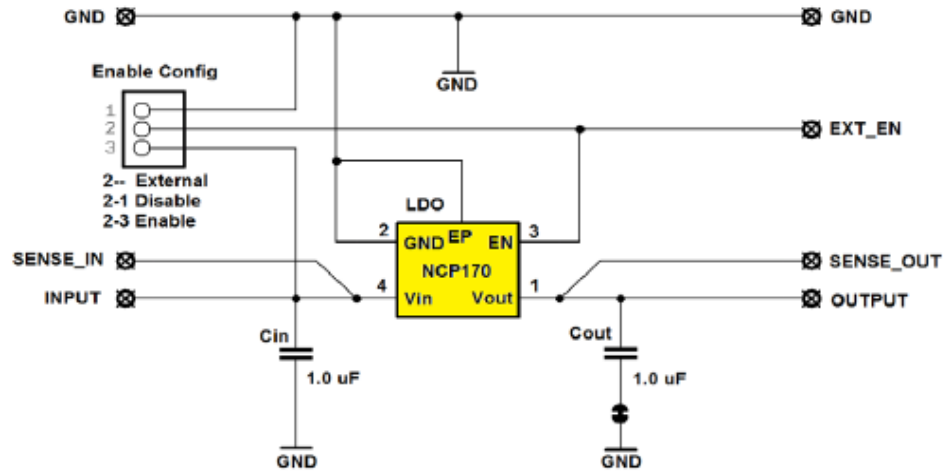

Programming I/F

