

PAGE 1/2	ISSUE 17-06-19C	SERIES ATTENUATOR	PART NUMBER R417603110
----------	-----------------	-----------------------------	-------------------------------

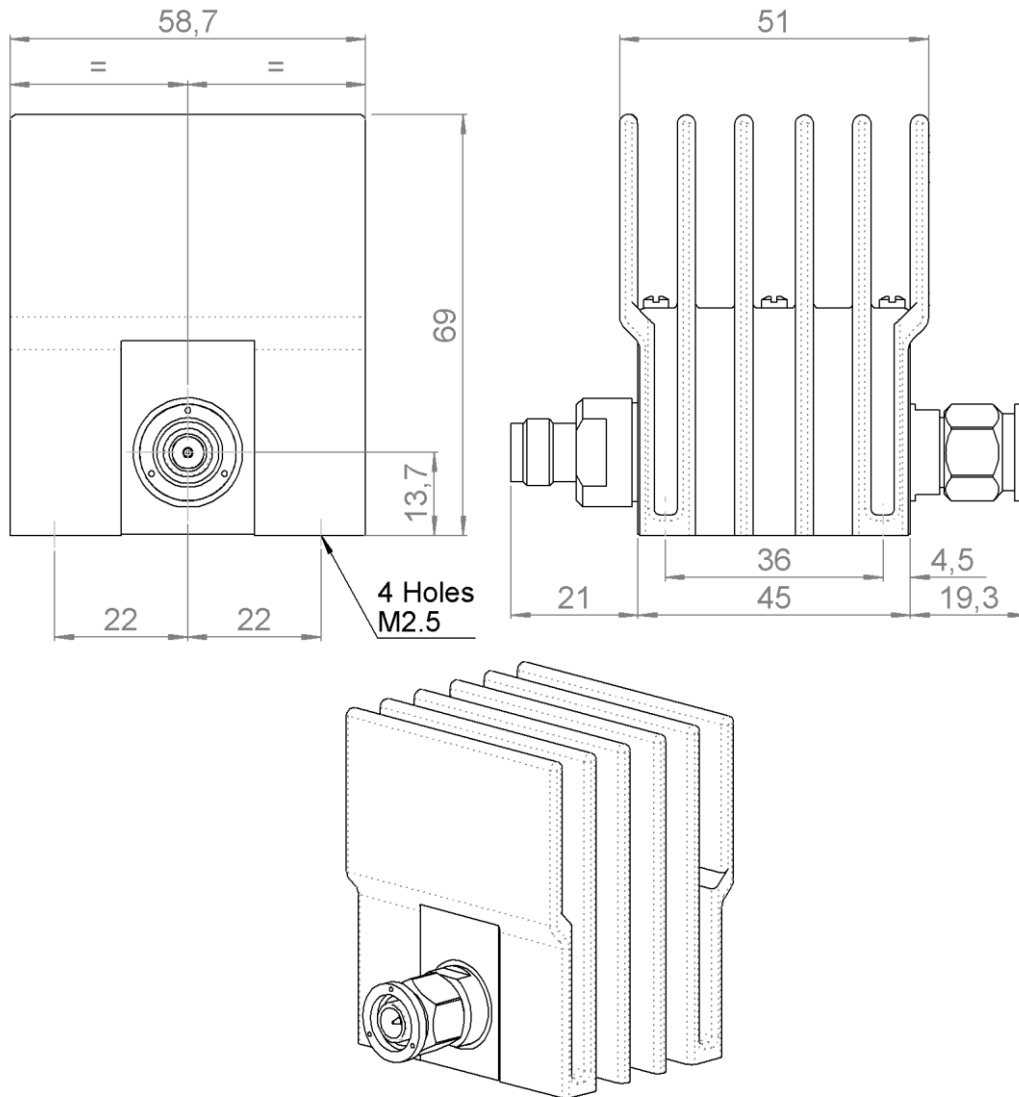

All dimensions are in mm. Tolerances according ISO 2768 m-H



COMPONENTS	MATERIALS	PLATING (µm)
Body	STAINLESS STEEL	PASSIVATED
Male center contact	BERYLLIUM COPPER	GOLD 0.5 OVER NICKEL PHOSPHORUS 2
Female center contact	BERYLLIUM COPPER	GOLD 0.5 OVER NICKEL PHOSPHORUS 2
Outer contact		
Insulator	PTFE	
Gasket	SILICONE RUBBER	
Substrate	ALUMINA	
Resistor	THICK FILM	
Others parts	ALUMINIUM	BLACK ANODIZATION

PAGE 2/2	ISSUE 17-06-19C	SERIES ATTENUATOR	PART NUMBER R417603110
----------	-----------------	-----------------------------	-------------------------------

ELECTRICAL CHARACTERISTICS

Frequency (GHz)	DC - 1	1 - 2	2 - 4
V.S.W.R (≤)	1.10	1.20	1.35
Deviation(±dB)	0.6	0.6	0.6

Operating Frequency Range	DC - 4	GHz
Impedance	50	Ω
Nominal Attenuation	3	dB
Peak power at 25°C (1μs, 1%)	5000	W
Average power at 25°C	25	W (Free Air Cooled)
		W (Conduction Cooled)

MECHANICAL CHARACTERISTICS

Connectors	TNC	Male Female	MIL-C 39012
Weight	305,9500	g	

ENVIRONMENTAL CHARACTERISTICS

Operating temperature range	-55 /+125	°C
Storage temperature range	-55 /+125	°C

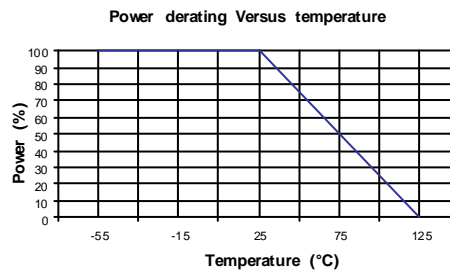

SPECIFICATION

OTHER CHARACTERISTICS