

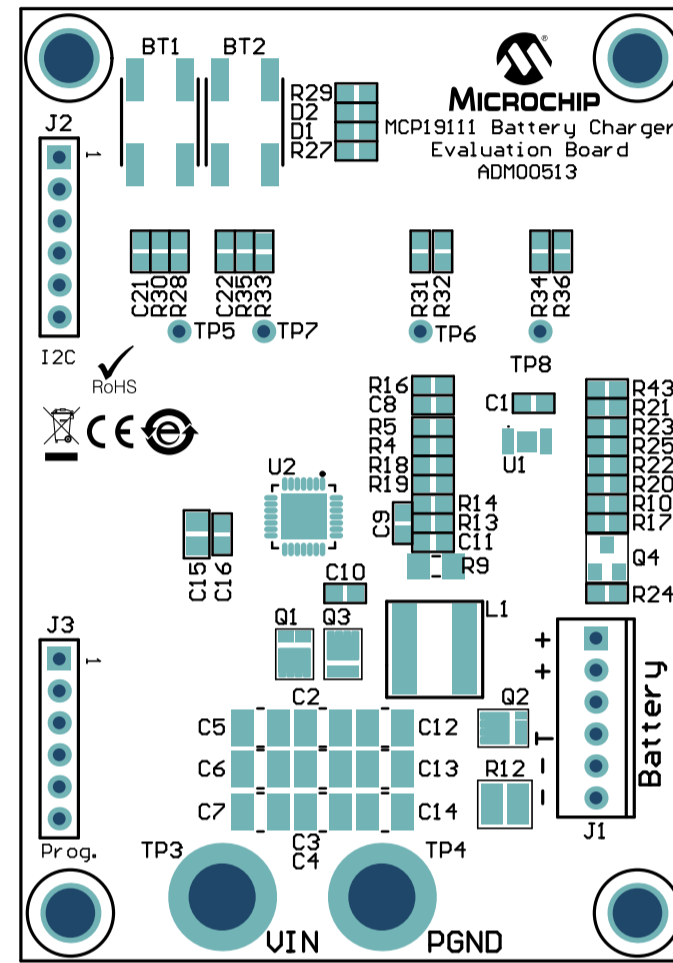



REV	ECO	Comments	Date

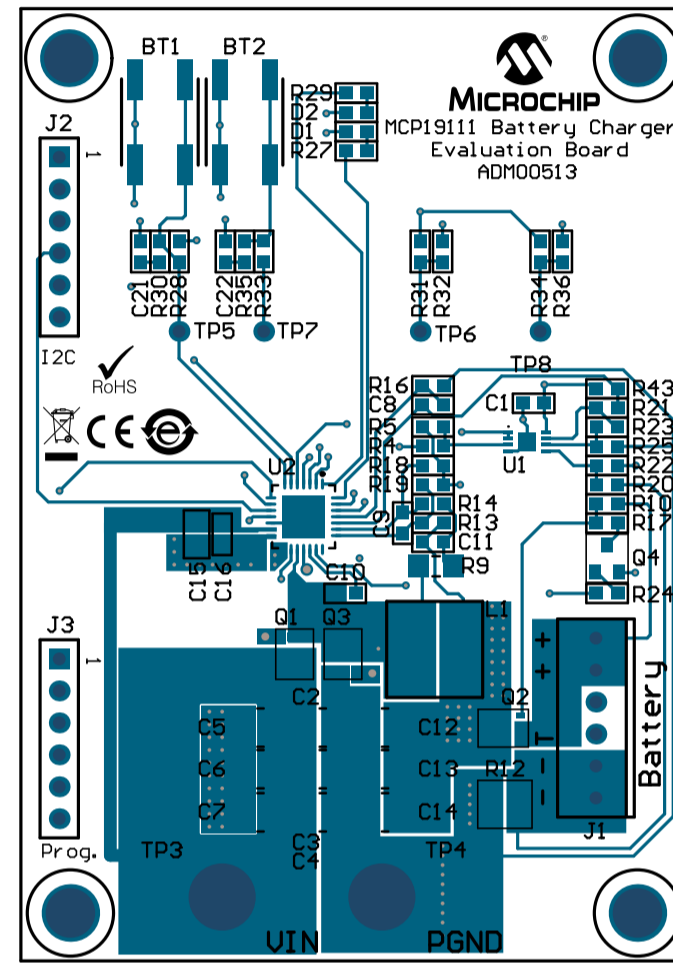

 MICROCHIP Microchip Technology Inc. 2355 W. Chandler Blvd. Chandler, AZ 85224	TITLE: MCP19111 Battery Charger Evaluation Board PART NUMBER: ADM00513	
	PCB DESIGNER: Joseph Depew	GERBER FILE: TOP Silk
	ENGINEER: Train Lin	BOARD NUMBER: 04-10117
	PCB FILE NAME: 04-10117-R2.PcbDoc	DATE: 9/2/2015 LAYER NAME: Board (12)
REV: 2	10mm 400mi	DATE: 9/2/2015

REV	ECO	Comments	Date

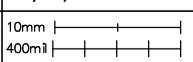

 MICROCHIP Microchip Technology Inc. 2355 W. Chandler Blvd. Chandler, AZ 85224	TITLE: MCP19111 Battery Charger Evaluation Board		PART NUMBER: ADM00513
	PCB DESIGNER: Joseph Depew	GERBER FILE: TOP Copper & Silk	
	ENGINEER: Train Lin	BOARD NUMBER: 04-10117	DATE: 9/2/2015
	PCB FILE NAME: 04-10117-R2.PcbDoc	LAYER NAME: Board (12)	REV: 2
			

1 2 3 4 5 6

REV	ECO	Comments	Date

A

A

B

B

C

C

D

D

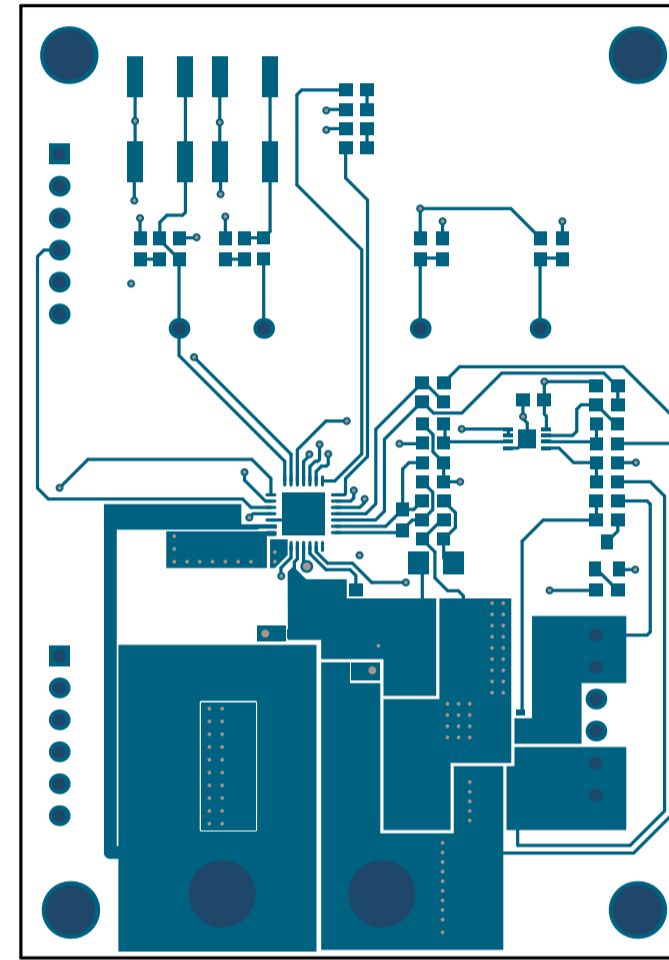

 MICROCHIP Microchip Technology Inc. 2355 W. Chandler Blvd. Chandler, AZ 85224	TITLE: MCP19111 Battery Charger Evaluation Board		PART NUMBER: ADM00513
	PCB DESIGNER: Joseph Depew	GERBER FILE: TOP Copper	
	ENGINEER: Train Lin	BOARD NUMBER: 04-10117	DATE: 9/2/2015
	PCB FILE NAME: 04-10117-R2.PcbDoc	LAYER NAME: BOARD (M2)	REV: 2

1 2 3 4 5 6

1 2 3 4 5 6

REV	ECO	Comments	Date

A

A

B

B

C

C

D

D

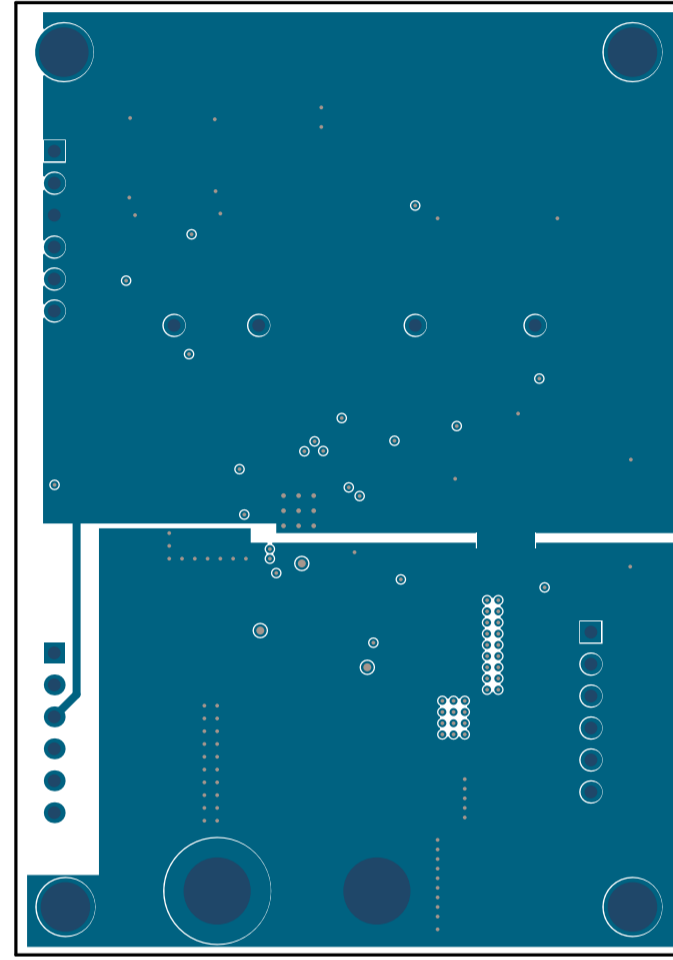

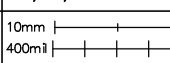
 MICROCHIP Microchip Technology Inc. 2355 W. Chandler Blvd. Chandler, AZ 85224	TITLE: MCP19111 Battery Charger Evaluation Board		PART NUMBER: ADM00513	
	PCB DESIGNER: Joseph Depew	GERBER FILE: Inner 1		
	ENGINEER: Train Lin	BOARD NUMBER: 04-10117	DATE: 9/2/2015	
	PCB FILE NAME: 04-10117-R2.PcbDoc	LAYER NAME: BOARD (M2)	REV: 2	

1 2 3 4 5 6

1 2 3 4 5 6

REV	ECO	Comments	Date

A

A

B

B

C

C

D

D

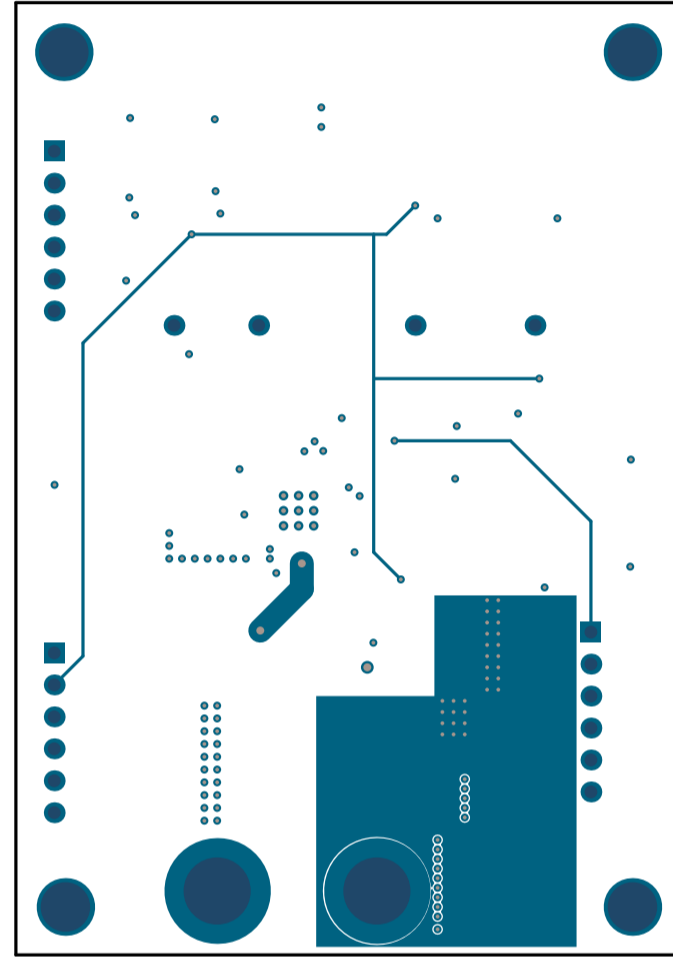

 MICROCHIP Microchip Technology Inc. 2355 W. Chandler Blvd. Chandler, AZ 85224	TITLE: MCP19111 Battery Charger Evaluation Board		PART NUMBER: ADM00513
	PCB DESIGNER: Joseph Depew	GERBER FILE: Inner 2	
	ENGINEER: Train Lin	BOARD NUMBER: 04-10117	DATE: 9/2/2015
	PCB FILE NAME: 04-10117-R2.PcbDoc	LAYER NAME: BOARD (M2)	REV: 2

1 2 3 4 5 6

1 2 3 4 5 6

A

A

B

B

C

C

D

D

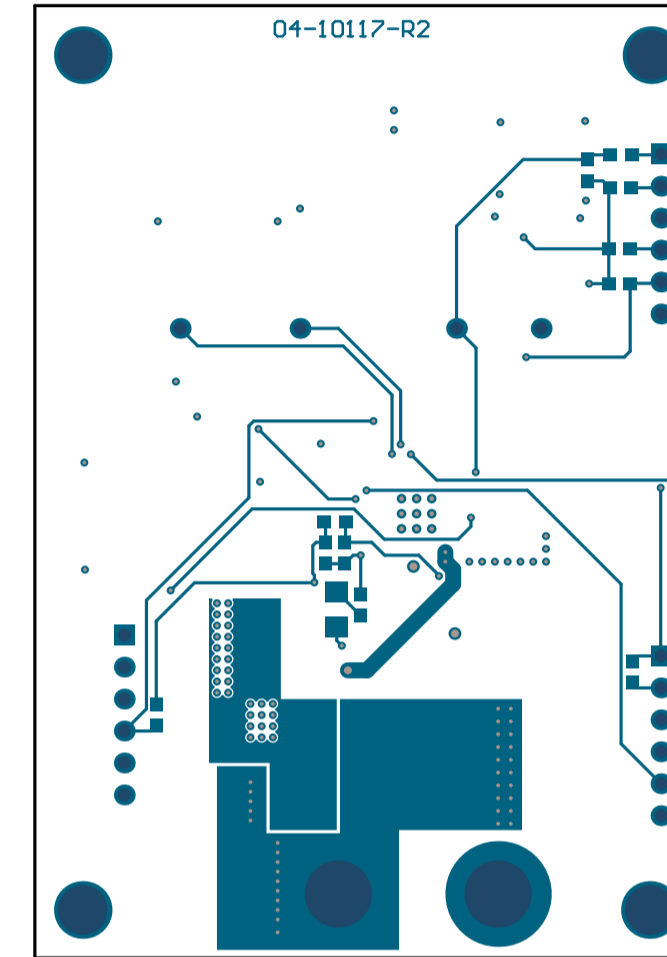

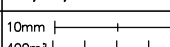
 MICROCHIP Microchip Technology Inc. 2355 W. Chandler Blvd. Chandler, AZ 85224	TITLE: MCP19111 Battery Charger Evaluation Board		PART NUMBER: ADM00513
	PCB DESIGNER: Joseph Depew	GERBER FILE: BOTTOM Copper	
	ENGINEER: Train Lin	BOARD NUMBER: 04-10117	DATE: 9/2/2015
	PCB FILE NAME: 04-10117-R2.PcbDoc	LAYER NAME:	REV: 

1 2 3 4 5 6

BOARD (M) (S)

1 2 3 4 5 6

A

A

B

B

C

C

D

D

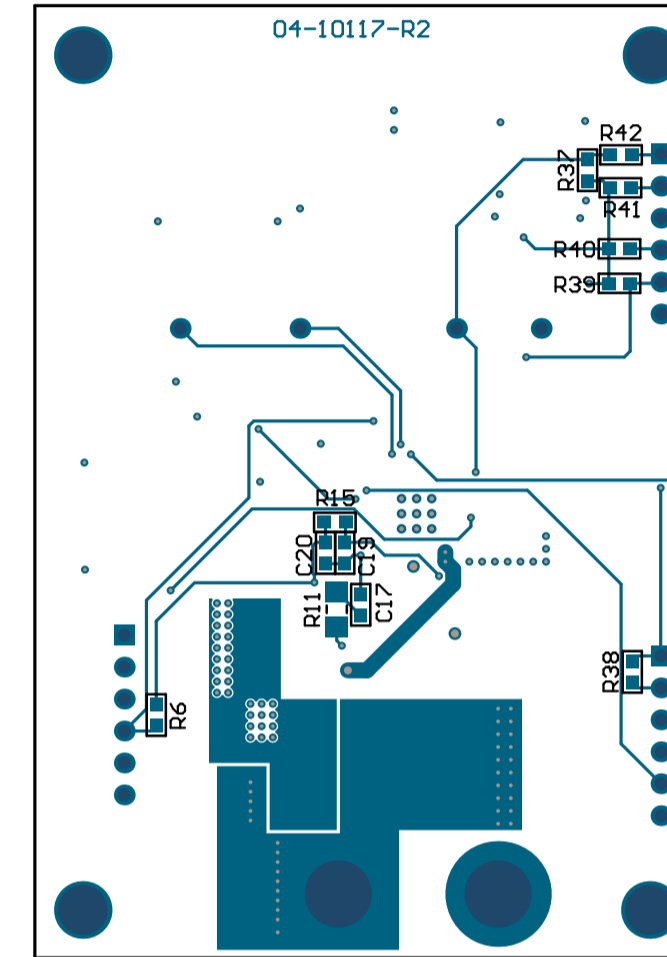

 MICROCHIP Microchip Technology Inc. 2355 W. Chandler Blvd. Chandler, AZ 85224	TITLE: MCP19111 Battery Charger Evaluation Board		PART NUMBER: ADM00513
	PCB DESIGNER: Joseph Depew	GERBER FILE: Bottom Copper & Silk	
	ENGINEER: Train Lin	BOARD NUMBER: 04-10117	DATE: 9/2/2015
	PCB FILE NAME: 04-10117-R2.PcbDoc	LAYER NAME:	REV:

1 2 3 4 5 6

100% OK

1 2 3 4 5 6

A

A

B

B

C

C

D

D

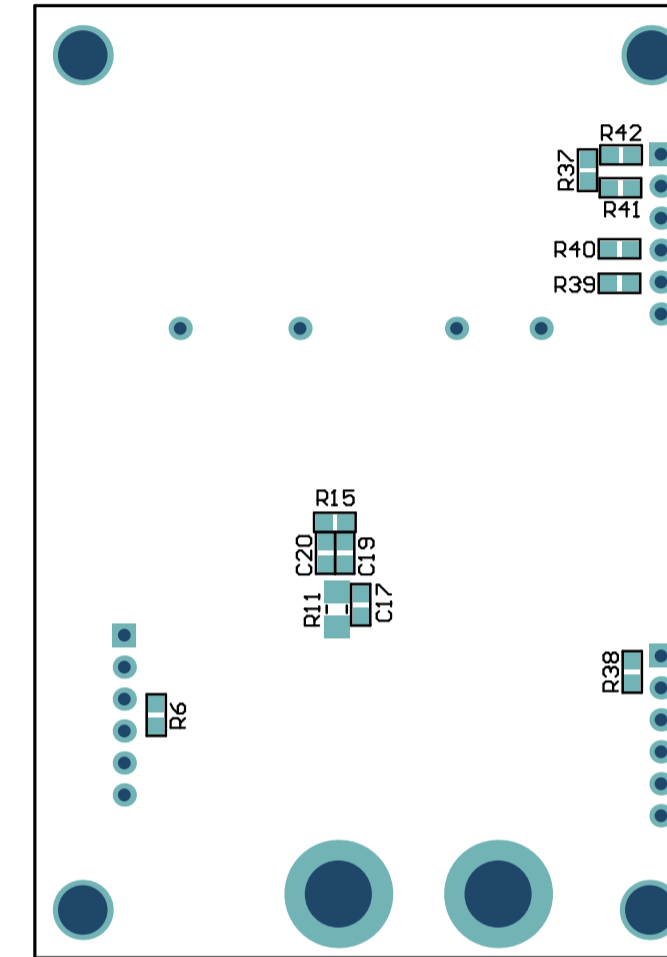

 MICROCHIP Microchip Technology Inc. 2355 W. Chandler Blvd. Chandler, AZ 85224	TITLE: MCP19111 Battery Charger Evaluation Board		PART NUMBER: ADM00513
	PCB DESIGNER: Joseph Depew	GERBER FILE: BOTTOM Silk	
	ENGINEER: Train Lin	BOARD NUMBER: 04-10117	DATE: 9/2/2015
	PCB FILE NAME: 04-10117-R2.PcbDoc	LAYER NAME:	REV: 10mm 400mil

1 2 3 4 5 6