

## SUMMARY

### # Wires

Low voltage 5



Image is for illustrative purpose only

|                  |                                   |
|------------------|-----------------------------------|
| Series           | OB                                |
| Termination type | Male solder                       |
| IP rating        | 50                                |
| AWG wire size    | 30.00 - 22.00                     |
| Cable Ø          | 0.00 - 0.00 mm                    |
| Status           | active                            |
| Matching parts   | <a href="#">PHG.OB.305.CLLD32</a> |

### Download

[Request a quote](#)

[Catalog](#)

## TECHNICAL DETAILS

### Mechanics

|                   |   |
|-------------------|---|
| Shell Style/Model | FA*: Fixed plug, non-latching, nut fixing   |
| Keying            | 1 key (alpha=0, plug: male contacts, receptacle: female contacts)   |
| Housing Material  | Brass (chrome plated [SAE AMS 2460]) shell and collet nut, nickel plated [SAE AMS QQ N 290] brass latch sleeve and mid pieces |
| Weight            | 5.15 g  |

### Performance

|               |                           |
|---------------|---------------------------|
| Configuration | OB.305 : 5 Low Voltage    |
| Insulator     | L: PEEK (UL 94 / V-0/1.5) |
| Rated Current | 6.5 Amps                  |

### Specifications

Contact Type: Solder  
Contact Dia.: 0.7 mm (0.028in)  
Bucket Dia.: 0.8 mm (0.031in)  
Max. Stranded Conductor: 0.34 mm<sup>2</sup> (AWG 22)  
Max. Conductor: 0.34 mm<sup>2</sup> (AWG 22)  
R (max): 6.1 mOhm  
Vtest (contact-shell): 700 V (AC), 1000 V (DC)  
Vtest (contact-contact): 1000 V (AC), 1400 V (DC)

LEMO products and services are provided "as is". LEMO makes no warranties or representations with regard to LEMO product & services or use of them, express, implied or statutory, including for accuracy, completeness, or security. The user is fully responsible for his products and applications using LEMO components.

## Others

Endurance (Shell): 5000  
 Temp (min / max): -55° C / +250° C  
 Humidity (max): <=95% [at 60 deg C / 140 F]  
 Vibration: 15 g [10 Hz - 2000 Hz]  
 Shock Resistance: 100 g [ 6 ms]  
 Climatical Category: 50/175/21  
 Shielding (min): 75 dB (10 MHz)  
 Shielding (min): 40 dB (1 GHz)  
 Salt Spray Corrosion: >1000 hr

## DRAWINGS

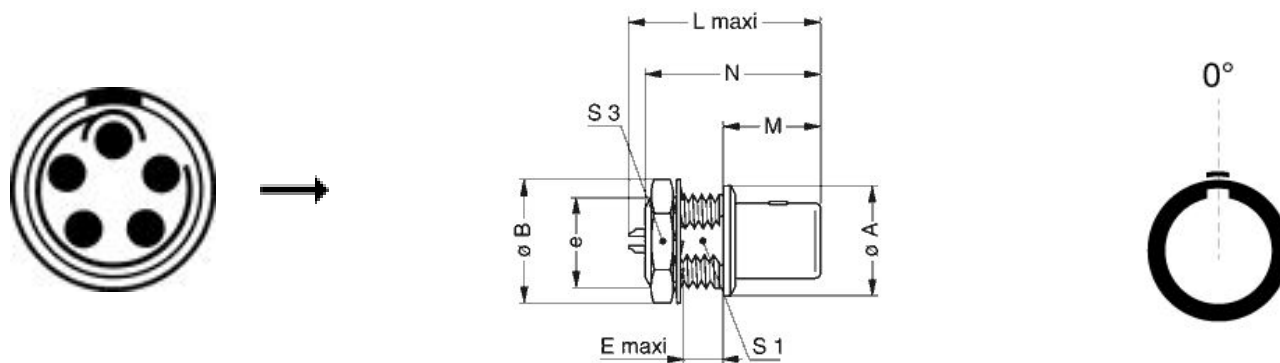

## Dimensions









|     | A    | B    | E    | L    | M    | N    | S1   | S3   | e      |
|-----|------|------|------|------|------|------|------|------|--------|
| mm. | 10   | 12.5 | 4.2  | 20.8 | 11.5 | 18.9 | 8.2  | 11   | M9x0.6 |
| in. | 0,39 | 0,49 | 0,17 | 0,82 | 0,45 | 0,74 | 0,32 | 0,43 |        |

## RECOMMENDED BY LEMO

### Tools

*LEMO products and services are provided "as is". LEMO makes no warranties or representations with regard to LEMO product & services or use of them, express, implied or statutory, including for accuracy, completeness, or security. The user is fully responsible for his products and applications using LEMO components.*

## Cables

|                    |               |       |   |
|--------------------|---------------|-------|---|
| CMN.05.T22.051QGZE | TPR (medical) | Grey  |  |
| CMN.05.T28.029PGCE | PVC           | GREY  |   |
| CMN.05.T28.029PGZE |               | Grey  |  |
| CMN.05.T28.029PNCE | PVC           | Black |   |
| CMN.05.T28.029PNZE |               |       |  |
| 150250             | PVC           | Grey  |   |
| 50090              | PVC           | Black |   |
| 50140              | PVC           | Grey  |  |
| 5050               | PVC           | Black |   |

LEMO products and services are provided "as is". LEMO makes no warranties or representations with regard to LEMO product & services or use of them, express, implied or statutory, including for accuracy, completeness, or security. The user is fully responsible for his products and applications using LEMO components.