

CARRIER TAPE SPEC FOR SMT SINGLE VERTICAL HEADER OF NANO-FIT					
CARRIER TAPE NUMBER	DIM A	DIM B	DIM D	DIM E	DIM F
105431-8001	24.00	N/A	11.50	8.63	6.97
105431-8002	24.00	N/A	11.50	11.13	9.47
105431-8003	32.00	28.40	14.20	13.63	11.97
105431-8004	32.00	28.40	14.20	16.13	14.47
105431-8005	44.00	40.40	20.20	18.63	16.97
105431-8006	44.00	40.40	20.20	21.13	19.47
105431-8007	44.00	40.40	20.20	23.63	21.97

NOTES :
1. REELING DIRECTION IN DELIVERY.

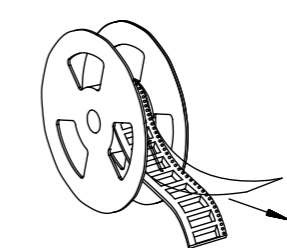

USER FEEDING DIRECTION



SECTION B-B

2. USER FEEDING DIRECTION

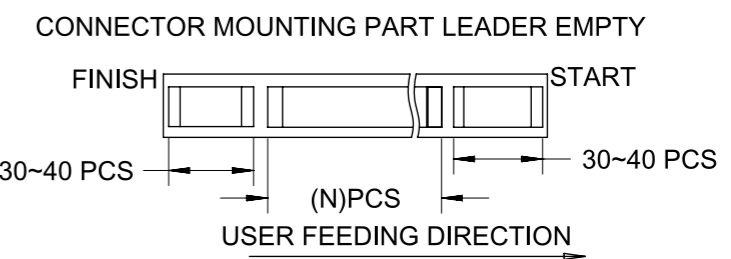

3. COVER TAPE PEELING FORCE

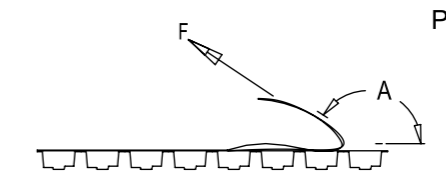

PEELING SPEED 300mm/Min.(REF.)

A	170°~180°
F	0.1N~1.3N

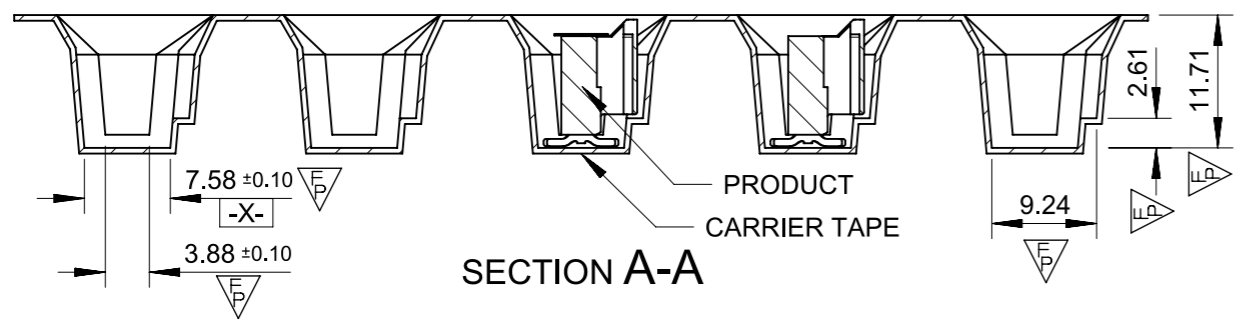

SECTION A-A

USER FEEDING DIRECTION

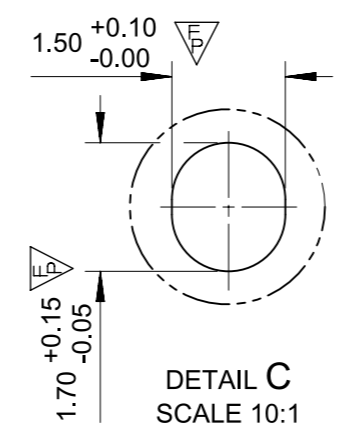

DETAIL C
SCALE 10:1

NANO-FIT CONNECTOR FULLY LOADED

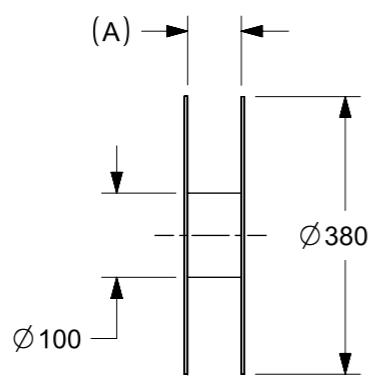
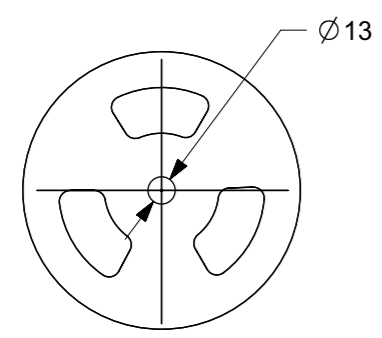
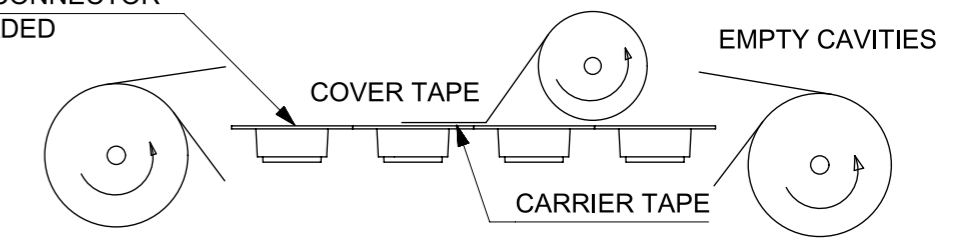

FUNCTIONAL SYMBOLS	THIS DRAWING CONTAINS INFORMATION THAT IS PROPRIETARY TO MOLEX ELECTRONIC TECHNOLOGIES, LLC AND SHOULD NOT BE USED WITHOUT WRITTEN PERMISSION		CURRENT REV DESC:		molex																																			
<table border="1"> <tr> <th>DIMENSION UNITS</th> <th>SCALE</th> </tr> <tr> <td>mm</td> <td>1:1</td> </tr> </table>	DIMENSION UNITS	SCALE	mm	1:1		GENERAL TOLERANCES (UNLESS SPECIFIED)		EC NO: 670810		PACKING DRAWING FOR NANO-FIT																														
DIMENSION UNITS	SCALE																																							
mm	1:1																																							
<table border="1"> <tr> <th>ANGULAR TOL</th> <th>±</th> <th>°</th> </tr> <tr> <td>4 PLACES</td> <td>±</td> <td></td> </tr> <tr> <td>3 PLACES</td> <td>±</td> <td></td> </tr> <tr> <td>2 PLACES</td> <td>±</td> <td>0.13</td> </tr> <tr> <td>1 PLACE</td> <td>±</td> <td>0.25</td> </tr> <tr> <td>0 PLACES</td> <td>±</td> <td></td> </tr> </table>	ANGULAR TOL	±	°	4 PLACES	±		3 PLACES	±		2 PLACES	±	0.13	1 PLACE	±	0.25	0 PLACES	±		<table border="1"> <tr> <td>DRWN: GLLI</td> <td>2021/07/21</td> </tr> <tr> <td>APPR: YXZHENG</td> <td>2021/07/22</td> </tr> </table>		DRWN: GLLI	2021/07/21	APPR: YXZHENG	2021/07/22	<table border="1"> <tr> <td>DRWN: GLLI</td> <td>2021/07/21</td> </tr> <tr> <td>APPR: YXZHENG</td> <td>2021/07/22</td> </tr> </table>		DRWN: GLLI	2021/07/21	APPR: YXZHENG	2021/07/22	PRODUCT CUSTOMER DRAWING									
ANGULAR TOL	±	°																																						
4 PLACES	±																																							
3 PLACES	±																																							
2 PLACES	±	0.13																																						
1 PLACE	±	0.25																																						
0 PLACES	±																																							
DRWN: GLLI	2021/07/21																																							
APPR: YXZHENG	2021/07/22																																							
DRWN: GLLI	2021/07/21																																							
APPR: YXZHENG	2021/07/22																																							
<table border="1"> <tr> <th>DIVISIONAL SYMBOLS</th> <th>±</th> <th></th> </tr> <tr> <td>4 PLACES</td> <td>±</td> <td></td> </tr> <tr> <td>3 PLACES</td> <td>±</td> <td></td> </tr> <tr> <td>2 PLACES</td> <td>±</td> <td>0.13</td> </tr> <tr> <td>1 PLACE</td> <td>±</td> <td>0.25</td> </tr> <tr> <td>0 PLACES</td> <td>±</td> <td></td> </tr> </table>	DIVISIONAL SYMBOLS	±		4 PLACES	±		3 PLACES	±		2 PLACES	±	0.13	1 PLACE	±	0.25	0 PLACES	±		<table border="1"> <tr> <td>DRWN: GLLI</td> <td>2021/07/21</td> </tr> <tr> <td>APPR: YXZHENG</td> <td>2021/07/22</td> </tr> </table>		DRWN: GLLI	2021/07/21	APPR: YXZHENG	2021/07/22	<table border="1"> <tr> <th>DOCUMENT NUMBER</th> <th>DOC TYPE</th> <th>DOC PART</th> <th>REVISION</th> </tr> <tr> <td>1054311000-PK</td> <td>PSD</td> <td>000</td> <td>A</td> </tr> </table>	DOCUMENT NUMBER	DOC TYPE	DOC PART	REVISION	1054311000-PK	PSD	000	A	<table border="1"> <tr> <th>MATERIAL NUMBER</th> <th>CUSTOMER</th> <th>SHEET NUMBER</th> </tr> <tr> <td></td> <td>GENERAL MARKET</td> <td>1 OF 2</td> </tr> </table>	MATERIAL NUMBER	CUSTOMER	SHEET NUMBER		GENERAL MARKET	1 OF 2
DIVISIONAL SYMBOLS	±																																							
4 PLACES	±																																							
3 PLACES	±																																							
2 PLACES	±	0.13																																						
1 PLACE	±	0.25																																						
0 PLACES	±																																							
DRWN: GLLI	2021/07/21																																							
APPR: YXZHENG	2021/07/22																																							
DOCUMENT NUMBER	DOC TYPE	DOC PART	REVISION																																					
1054311000-PK	PSD	000	A																																					
MATERIAL NUMBER	CUSTOMER	SHEET NUMBER																																						
	GENERAL MARKET	1 OF 2																																						
<table border="1"> <tr> <th>DRAFT WHERE APPLICABLE MUST REMAIN WITHIN DIMENSIONS</th> <th>THIRD ANGLE PROJECTION</th> <th>DRAWING</th> <th>SERIES</th> <th>MATERIAL NUMBER</th> <th>CUSTOMER</th> <th>SHEET NUMBER</th> </tr> <tr> <td></td> <td></td> <td>A3-SIZE</td> <td>105431</td> <td></td> <td>GENERAL MARKET</td> <td>1 OF 2</td> </tr> </table>	DRAFT WHERE APPLICABLE MUST REMAIN WITHIN DIMENSIONS	THIRD ANGLE PROJECTION	DRAWING	SERIES	MATERIAL NUMBER	CUSTOMER	SHEET NUMBER			A3-SIZE	105431		GENERAL MARKET	1 OF 2																										
DRAFT WHERE APPLICABLE MUST REMAIN WITHIN DIMENSIONS	THIRD ANGLE PROJECTION	DRAWING	SERIES	MATERIAL NUMBER	CUSTOMER	SHEET NUMBER																																		
		A3-SIZE	105431		GENERAL MARKET	1 OF 2																																		



REEL	COVER TAPE	CARRIER TAPE	PRODUCT NUMBER		PARTS PER REEL	REELS PER CARTON	PARTS PER CARTON	
885961399	894990121	105431-8001	WITH MYLAR	105431-1102, 105431-1202, 105431-1302, 105431-1402	300	3	900	
			WITHOUT MYLAR	105431-1502, 105431-1602, 105431-1702, 105431-1802				
			WITHOUT MYLAR	105431-2502, 105431-2602, 105431-2702, 105431-2802				
		105431-8002	WITH MYLAR	105431-1103, 105431-1203, 105431-1303, 105431-1403				
			WITHOUT MYLAR	105431-2103, 105431-2203, 105431-2303, 105431-2403				
			WITHOUT MYLAR	105431-1503, 105431-1603, 105431-1703, 105431-1803				
885961400	894990122	105431-8003	WITH MYLAR	105431-1104, 105431-1204, 105431-1304, 105431-1404	300	3	900	
			WITHOUT MYLAR	105431-2104, 105431-2204, 105431-2304, 105431-2404				
			WITHOUT MYLAR	105431-1504, 105431-1604, 105431-1704, 105431-1804				
		105431-8004	WITH MYLAR	105431-1105, 105431-1205, 105431-1305, 105431-1405				
			WITHOUT MYLAR	105431-2105, 105431-2205, 105431-2305, 105431-2405				
			WITHOUT MYLAR	105431-1505, 105431-1605, 105431-1705, 105431-1805				
885961401	894990123	105431-8005	WITH MYLAR	105431-1106, 105431-1206, 105431-1306, 105431-1406	300	2	600	
			WITHOUT MYLAR	105431-2106, 105431-2206, 105431-2306, 105431-2406				
			WITHOUT MYLAR	105431-1506, 105431-1606, 105431-1706, 105431-1806				
			105431-8006	WITH MYLAR				105431-1107, 105431-1207, 105431-1307, 105431-1407
				WITHOUT MYLAR				105431-2107, 105431-2207, 105431-2307, 105431-2407
				WITHOUT MYLAR				105431-1507, 105431-1607, 105431-1707, 105431-1807
		105431-8007	WITH MYLAR	105431-1108, 105431-1208, 105431-1308, 105431-1408	300	2	600	
			WITHOUT MYLAR	105431-2108, 105431-2208, 105431-2308, 105431-2408				
			WITHOUT MYLAR	105431-1508, 105431-1608, 105431-1708, 105431-1808				
			WITHOUT MYLAR	105431-2508, 105431-2608, 105431-2708, 105431-2808				
			WITHOUT MYLAR	105431-2508, 105431-2608, 105431-2708, 105431-2808				
			WITHOUT MYLAR	105431-2508, 105431-2608, 105431-2708, 105431-2808				

- NOTES :
1. STAPLES SHOULD ONLY BE USED TO SET UP CARTON. ALL CARTONS CLOSURES MUST BE DONE WITH TAPE.
 2. FILL PACKAGING BAGS WITH THE QUANTITIES AS INDICATED IN THE CHART



THIS DRAWING CONTAINS INFORMATION THAT IS PROPRIETARY TO MOLEX ELECTRONIC TECHNOLOGIES, LLC AND SHOULD NOT BE USED WITHOUT WRITTEN PERMISSION											
FUNCTIONAL SYMBOLS	DIMENSION UNITS	SCALE	CURRENT REV DESC:								
$\nabla_A = 0$	mm	1:1	molex PACKING DRAWING FOR NANO-FIT PRODUCT CUSTOMER DRAWING								
$\nabla_B = 0$	GENERAL TOLERANCES (UNLESS SPECIFIED)										
$\nabla_C = 0$	ANGULAR TOL ± °										
DIVISIONAL SYMBOLS											
	4 PLACES	±	EC NO: 670810	2021/07/21			2021/07/22				
	3 PLACES	±	DRWN: GLLI	2021/07/21			2021/07/22				
	2 PLACES	± 0.13	CHK'D: YXZHENG	2021/07/21			2021/07/22				
	1 PLACE	± 0.25	APPR: YXZHENG	2021/07/21			2021/07/22				
	0 PLACES	±	INITIAL REVISION:	2021/07/21			2021/07/22				
	DRAFT WHERE APPLICABLE MUST REMAIN WITHIN DIMENSIONS		THIRD ANGLE PROJECTION	DRAWING	SERIES	MATERIAL NUMBER	CUSTOMER	DOCUMENT NUMBER	DOC TYPE	DOC PART	REVISION
				A3-SIZE	105431	1054311000-PK	GENERAL MARKET	1054311000-PK	PSD	000	A



RECOMMENDED PCB LAYOUT(CONNECTOR SIDE VIEW)
THICKNESS=1.60mm MIN. TOLERANCE:±0.05



WITHOUT MYLAR



WITH MYLAR

THIS DRAWING CONTAINS INFORMATION THAT IS PROPRIETARY TO MOLEX ELECTRONIC TECHNOLOGIES, LLC AND SHOULD NOT BE USED WITHOUT WRITTEN PERMISSION												
QUALITY SYMBOLS ▽A = 0 ▽E = 0 ▽F = 0 ▼ = 0 ▽C = 0 ⊗ = 0 ■ = 0 ▽ = 0	2021/04/27	2021/07/22	2021/07/22	GENERAL TOLERANCES (UNLESS SPECIFIED)		DIMENSION UNITS	SCALE					
	2021/04/27	2021/07/22	2021/07/22	ANGULAR TOL ± 3.0 °		mm	5:1					
	EC NO: 670810 DRWN: GLLI CHK'D: YXZHENG APPR: YXZHENG	4 PLACES	±	DRWN BY		DATE	WJHUO		2014/10/30		SD DRAWING FOR NANO-FIT HEADER OF SMT VERTICAL SINGLE CONN.	
		3 PLACES	±	CHK'D BY		DATE						
		2 PLACES	± 0.2	APPR BY		DATE	AYIN		2015/03/12			
		1 PLACE	± 0.3	DRAWING SIZE		THIRD ANGLE PROJECTION	A3					
		0 PLACES	±	DRAFT WHERE APPLICABLE MUST REMAIN WITHIN DIMENSIONS								
	D1		REV	SERIES		MATERIAL NUMBER	CUSTOMER		PRODUCT CUSTOMER DRAWING			
				105431		SEE TABLE	GENERAL MARKET					
	RELEASE STATUS P1				RELEASE DATE	2021/07/22	09:31:37	DOCUMENT NUMBER		DOC TYPE	DOC PART	SHEET NUMBER
					2021/07/22	09:31:37	SD-105431-001		PSD	000	1 OF 4	

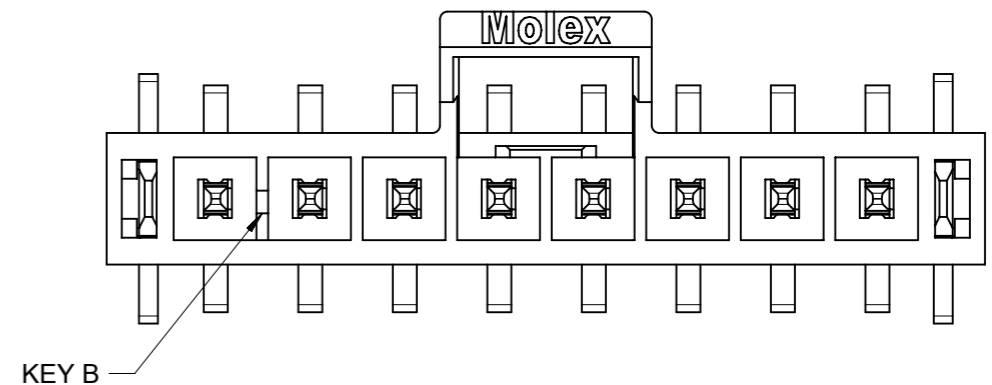
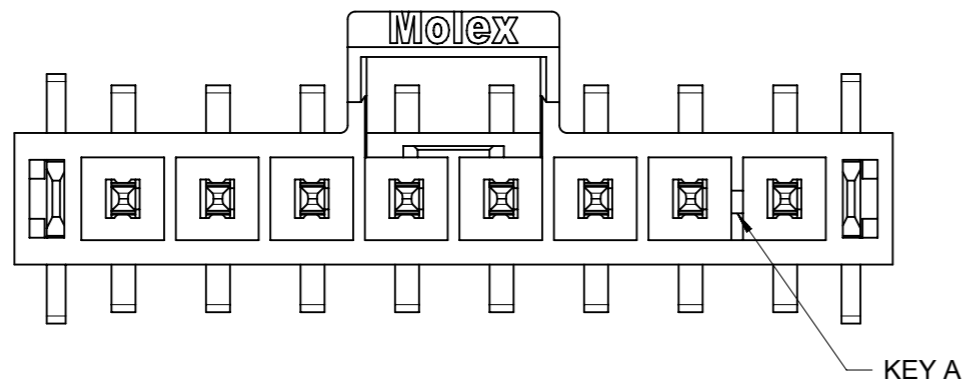
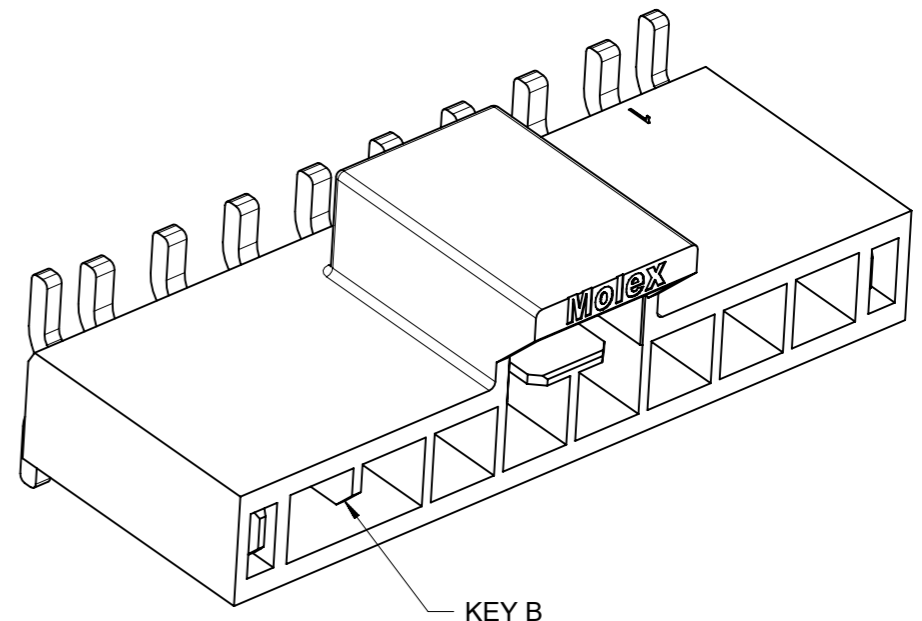
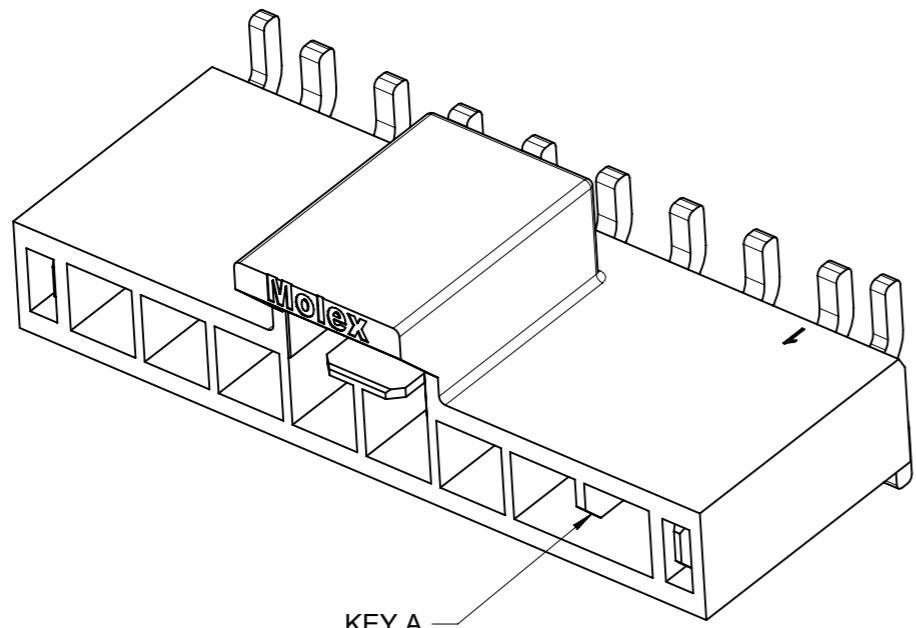

BLACK

NATURAL

COLOR OPTION

SYMBOLS DIMENSION UNITS: mm SCALE: 1:1 GENERAL TOLERANCES (UNLESS SPECIFIED): ANGULAR TOL ± 3.0° 4 PLACES ± 3 PLACES ± 2 PLACES ± 0.2 1 PLACE ± 0.3 0 PLACES ± DRAFT WHERE APPLICABLE MUST REMAIN WITHIN DIMENSIONS THIRD ANGLE PROJECTION DRAWING: A3-SIZE SERIES: 105431	THIS DRAWING CONTAINS INFORMATION THAT IS PROPRIETARY TO MOLEX ELECTRONIC TECHNOLOGIES, LLC AND SHOULD NOT BE USED WITHOUT WRITTEN PERMISSION			molex SD DRAWING FOR NANO-FIT HEADER OF SMT VERTICAL SINGLE CONN.			
	CURRENT REV DESC: EC NO: 670810 DRWN: GLLI 2021/04/27 CHK'D: YXZHENG 2021/07/22 APPR: YXZHENG 2021/07/22			PRODUCT CUSTOMER DRAWING			
	INITIAL REVISION: DRWN: RMV02 2016/01/14 APPR: AYIN 2017/05/15			DOCUMENT NUMBER SD-105431-001	DOC TYPE PSD	DOC PART 000	REVISION D1
	MATERIAL NUMBER 105431		CUSTOMER GENERAL MARKET		SHEET NUMBER 2 OF 4		

9		8			7		6		5		4		3			2		1	
PART NUMBER (WITH MYLAR)	PART NUMBER (WITHOUT MYLAR)	DIM. A	DIM. B	DIM. C	CKT SIZE	PLATING	LUBE					PART NUMBER (WITH MYLAR)	PART NUMBER (WITHOUT MYLAR)	DIM. A	DIM. B	DIM. C	CKT SIZE	PLATING	LUBE
105431-1102	105431-1502	8.23	2.50	6.11	2	TIN						105431-2102	105431-2502	8.23	2.50	6.11	2	TIN	
105431-1103	105431-1503	10.73	5.00	8.61	3							105431-2103	105431-2503	10.73	5.00	8.61	3		
105431-1104	105431-1504	13.23	7.50	11.11	4							105431-2104	105431-2504	13.23	7.50	11.11	4		
105431-1105	105431-1505	15.73	10.00	13.61	5							105431-2105	105431-2505	15.73	10.00	13.61	5		
105431-1106	105431-1506	18.23	12.50	16.11	6							105431-2106	105431-2506	18.23	12.50	16.11	6		
105431-1107	105431-1507	20.73	15.00	18.61	7							105431-2107	105431-2507	20.73	15.00	18.61	7		
105431-1108	105431-1508	23.23	17.50	21.11	8							105431-2108	105431-2508	23.23	17.50	21.11	8		
105431-1202	105431-1602	8.23	2.50	6.11	2			GOLD 0.38	NO					105431-2202	105431-2602	8.23	2.50		
105431-1203	105431-1603	10.73	5.00	8.61	3							105431-2203	105431-2603	10.73	5.00	8.61	3		
105431-1204	105431-1604	13.23	7.50	11.11	4							105431-2204	105431-2604	13.23	7.50	11.11	4		
105431-1205	105431-1605	15.73	10.00	13.61	5							105431-2205	105431-2605	15.73	10.00	13.61	5		
105431-1206	105431-1606	18.23	12.50	16.11	6							105431-2206	105431-2606	18.23	12.50	16.11	6		
105431-1207	105431-1607	20.73	15.00	18.61	7							105431-2207	105431-2607	20.73	15.00	18.61	7		
105431-1208	105431-1608	23.23	17.50	21.11	8							105431-2208	105431-2608	23.23	17.50	21.11	8		
105431-1302	105431-1702	8.23	2.50	6.11	2	GOLD 0.76								105431-2302	105431-2702	8.23	2.50	6.11	2
105431-1303	105431-1703	10.73	5.00	8.61	3							105431-2303	105431-2703	10.73	5.00	8.61	3		
105431-1304	105431-1704	13.23	7.50	11.11	4							105431-2304	105431-2704	13.23	7.50	11.11	4		
105431-1305	105431-1705	15.73	10.00	13.61	5							105431-2305	105431-2705	15.73	10.00	13.61	5		
105431-1306	105431-1706	18.23	12.50	16.11	6							105431-2306	105431-2706	18.23	12.50	16.11	6		
105431-1307	105431-1707	20.73	15.00	18.61	7							105431-2307	105431-2707	20.73	15.00	18.61	7		
105431-1308	105431-1708	23.23	17.50	21.11	8							105431-2308	105431-2708	23.23	17.50	21.11	8		
105431-1402	105431-1802	8.23	2.50	6.11	2			GOLD 0.76	YES					105431-2402	105431-2802	8.23	2.50	6.11	2
105431-1403	105431-1803	10.73	5.00	8.61	3							105431-2403	105431-2803	10.73	5.00	8.61	3		
105431-1404	105431-1804	13.23	7.50	11.11	4							105431-2404	105431-2804	13.23	7.50	11.11	4		
105431-1405	105431-1805	15.73	10.00	13.61	5							105431-2405	105431-2805	15.73	10.00	13.61	5		
105431-1406	105431-1806	18.23	12.50	16.11	6							105431-2406	105431-2806	18.23	12.50	16.11	6		
105431-1407	105431-1807	20.73	15.00	18.61	7							105431-2407	105431-2807	20.73	15.00	18.61	7		
105431-1408	105431-1808	23.23	17.50	21.11	8							105431-2408	105431-2808	23.23	17.50	21.11	8		
		COLOR: BLACK										COLOR: NATURAL							

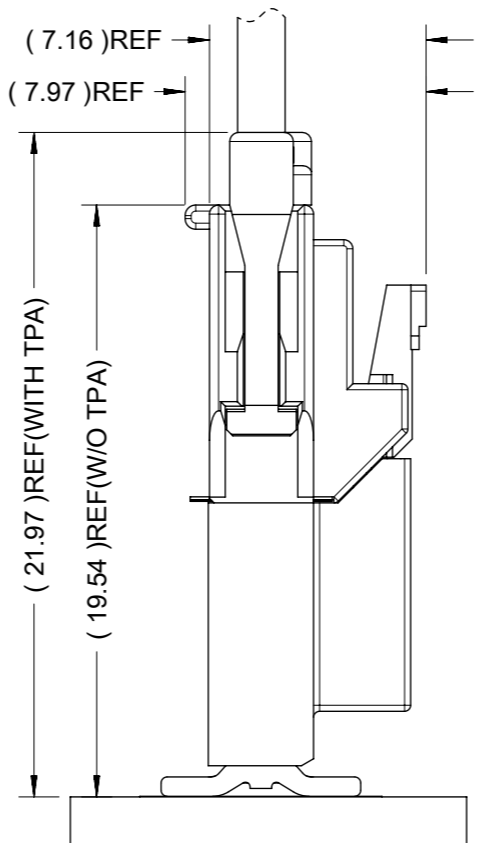

NOTES FOR ALL PARTS







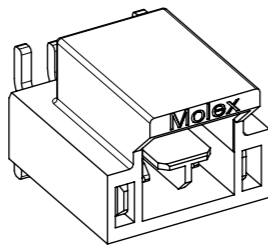
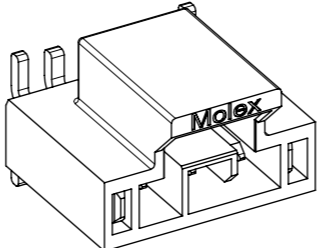
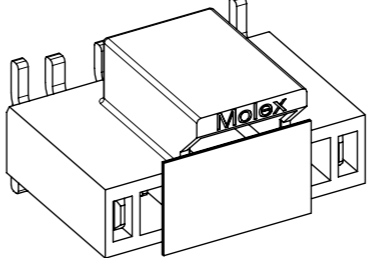
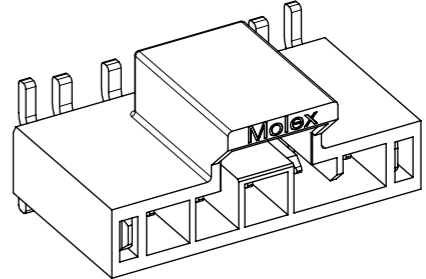
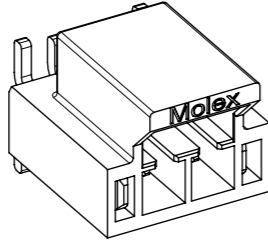
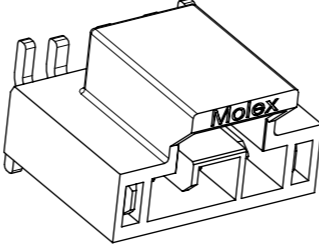
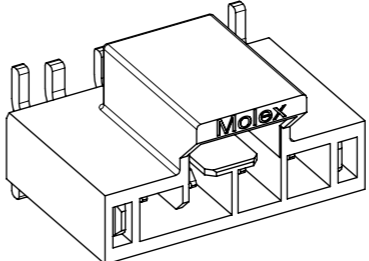
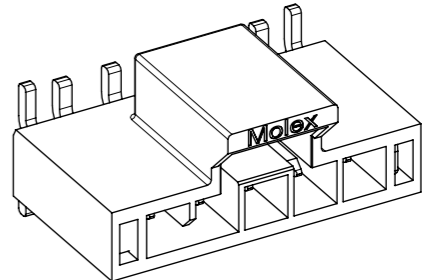
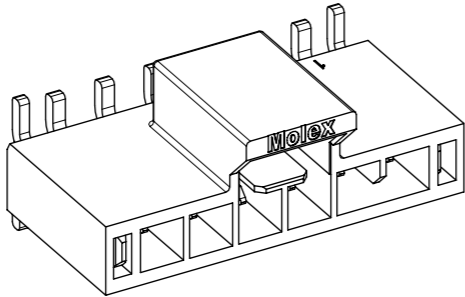
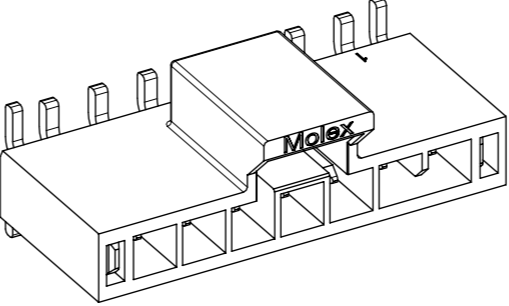
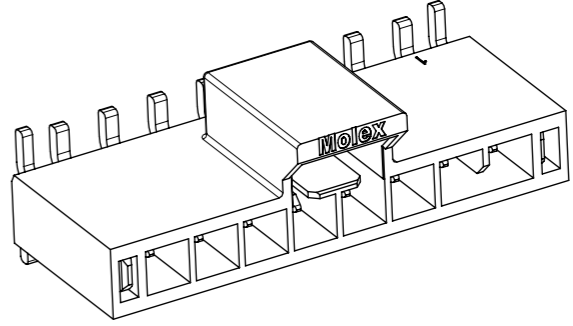
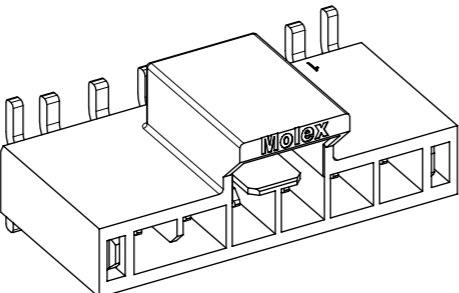
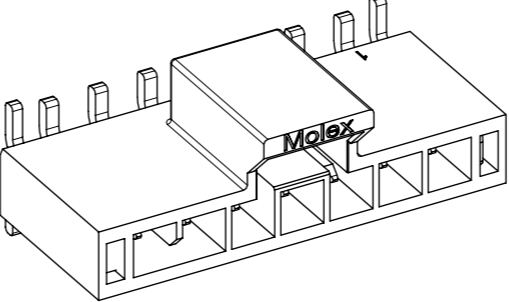
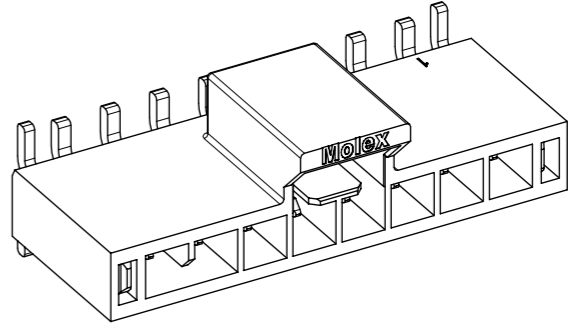

1> MATERIAL:
HOUSING: LCP, UL 94V-0.
TERMINAL: BRASS.
SOLDER CLIP: BRASS.

2> PLATING FINISHED:
TERMINAL:
CONTACT AREA:
a. REFLOWED MATTE TIN 0.76 MICRONS MIN; b. GOLD 0.38 MICRONS MIN; c. GOLD 0.76 MICRONS MIN.
SOLDER AREA: TIN 0.76 MICRONS MINIMUM.
UNDER PLATING NICKEL 1.25 MICRONS MINIMUM.
SOLDER CLIP: TIN 2.5 MICRONS MINIMUM; UNDER PLATING NICKEL 1.25 MICRONS MINIMUM.

3> PRODUCT SPECIFICATION: PS-105405-001.
4> PACKAGE: TAPE REEL, DETAILS REFER TO DRAWING 1054311000-PK.
5> ALL COMPONENTS AND PRODUCT COMPLIANT TO RoHS DIRECTIVE 2011/65/EU AND ELV DIRECTIVE 2000/53/EC.
6> PRODUCT MATE WITH SERIES OF 105307(RECEPTACLE), 105300(CRIMP TERMINAL).
7> PARTS CONFORM TO CLASS 'B' REQUIREMENTS OF COSMETIC SPECIFICATION PS-45499-002.

QUALITY SYMBOLS 	THIS DRAWING CONTAINS INFORMATION THAT IS PROPRIETARY TO MOLEX ELECTRONIC TECHNOLOGIES, LLC AND SHOULD NOT BE USED WITHOUT WRITTEN PERMISSION										
	EC NO: 670810 DRWN: GLLI CHK'D: YXZHENG APPR: YXZHENG	GENERAL TOLERANCES (UNLESS SPECIFIED) ANGULAR TOL ± 3.0 ° 4 PLACES ± 3 PLACES ± 2 PLACES ± 0.2 1 PLACE ± 0.3 0 PLACES ±		DIMENSION UNITS mm	SCALE 5:1	 SD DRAWING FOR NANO-FIT HEADER OF SMT VERTICAL SINGLE CONN.					
		DRWN BY WJHUO	DATE 2014/10/30	CHK'D BY AYIN	DATE 2015/03/12						
		DRAFT WHERE APPLICABLE MUST REMAIN WITHIN DIMENSIONS	A3	THIRD ANGLE PROJECTION 	SERIES 105431	MATERIAL NUMBER SEE TABLE	CUSTOMER GENERAL MARKET	DOCUMENT NUMBER SD-105431-001	DOC TYPE PSD	DOC PART 000	SHEET NUMBER 3 OF 4

	2 CKT	3 CKT	4 CKT	5 CKT
BLACK				
NATURAL				
	6 CKT	7 CKT	8 CKT	
BLACK				
NATURAL				

THIS DRAWING CONTAINS INFORMATION THAT IS PROPRIETARY TO MOLEX ELECTRONIC TECHNOLOGIES, LLC AND SHOULD NOT BE USED WITHOUT WRITTEN PERMISSION													
QUALITY SYMBOLS  = 0  = 0  = 0  = 0  = 0  = 0  = 0		EC NO: 670810 DRWN: GLLI CHK'D: YXZHENG APPR: YXZHENG		2021/04/27 2021/07/22 2021/07/22		GENERAL TOLERANCES (UNLESS SPECIFIED) ANGULAR TOL ± 3.0 ° 4 PLACES ± 3 PLACES ± 2 PLACES ± 0.2 1 PLACE ± 0.3 0 PLACES ±		DRAFT WHERE APPLICABLE MUST REMAIN WITHIN DIMENSIONS		DIMENSION UNITS: mm SCALE: 3:1 DRWN BY: RMV02 DATE: 2016/01/14 CHK'D BY: DATE: APPR BY: AYIN DATE: 2017/05/15		 SD DRAWING FOR NANO-FIT HEADER OF SMT VERTICAL SINGLE CONN.	
D1		REV		A3		THIRD ANGLE PROJECTION		PRODUCT CUSTOMER DRAWING		SERIES: 105431 MATERIAL NUMBER: CUSTOMER: GENERAL MARKET			
RELEASE STATUS: P1 RELEASE DATE: 2021/07/22 09:31:37		DOCUMENT NUMBER: SD-105431-001 DOC TYPE: PSD DOC PART: 000 SHEET NUMBER: 4 OF 4											