

REVISIONS					
REV	ECO	DESCRIPTION	DATE	BY	APPR
A3	-	RELEASE NEW DWG FORMAT	27DEC13	JARRY	

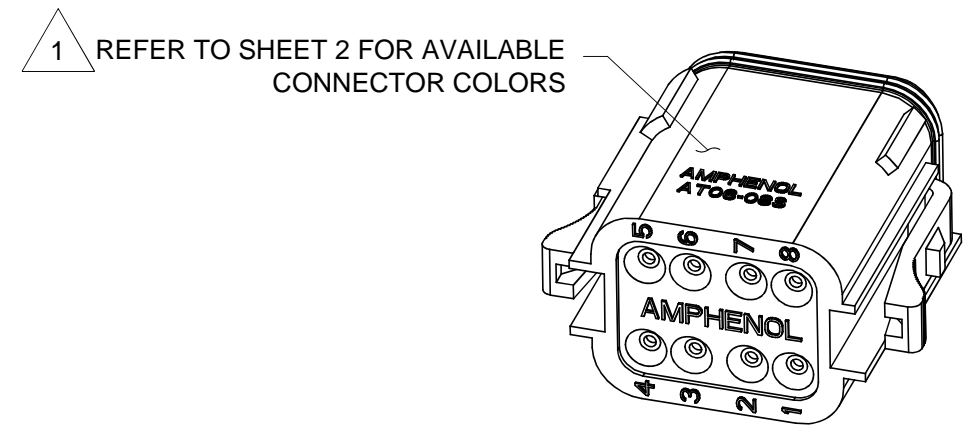
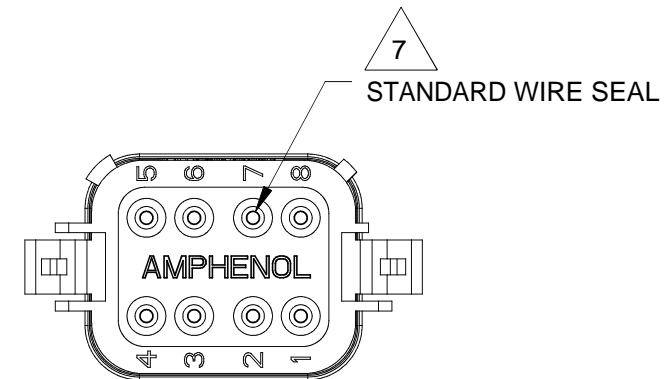
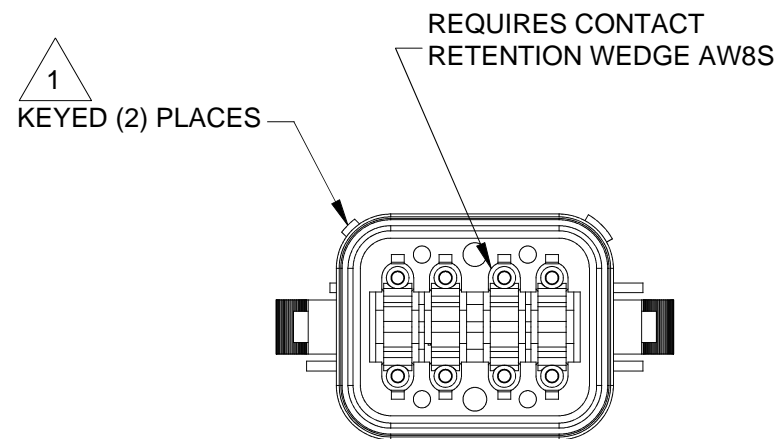
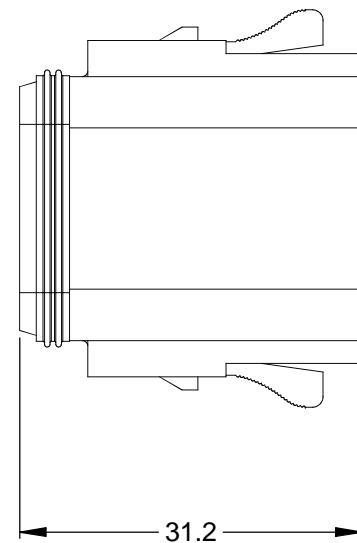
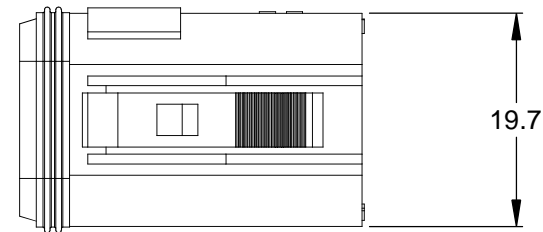
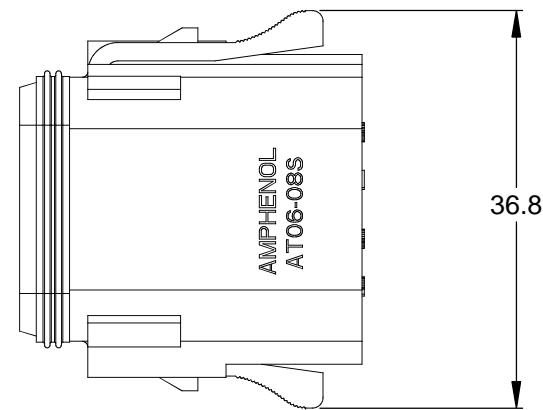

NOTES: UNLESS OTHERWISE SPECIFIED

1 SEE SHEET 2 FOR KEY ARRANGEMENTS AND COLORS.

2. MATERIAL:  
HOUSING: THERMOPLASTIC  
SEAL: SILICONE RUBBER

3. MODIFICATIONS: N/A

4. SPECIFICATIONS:  
4.1 CURRENT RATING: 13 AMPS  
4.2 OPERATING TEMPERATURE: -55°C TO +125°C  
4.3 DIELECTRIC WITHSTANDING VOLTAGE: LESS THAN 2 MILLIAMPS CURRENT LEAKAGE @ 1500 VOLTS AC.  
4.4 INSULATION RESISTANCE: 1000 MEGOHMS MIN @ 25°C.  
4.5 MOISTURE RESISTANCE: IP67 ( MATED CONDITION )  
4.6 MATING CYCLE DURABILITY: 100 CYCLES  
4.7 RoHS COMPLIANT

5. MATING PART: AT04-08PX\* RECEPTACLE  
( X = A,B,C,D KEYS; \* = MODIFICATIONS AND COLORS )

6. ALL DIMENSIONS ARE FOR REFERENCE USE ONLY.

7 CONTACT SIZE AND REAR SEAL WIRE RANGE:

CONTACT SIZE	MIN. INSUL O.D.	MAX. INSUL O.D.	TYPICAL WIRE RANGE
16	2.24 mm (.088 in)	3.68 mm (.145 in)	14 - 20 AWG

TITLE: PLUG, 8 SOCKET, AT SERIES, KEYED  
DWG NO.: AT06-08SX-XXX  
REV: A3  
SH: 1  
OF: 2

QUANTITY	SEE SHEET 2 PART NUMBER	DESCRIPTION	ITEM										
<b>MATERIALS LIST</b>													
UNLESS OTHERWISE SPECIFIED 1) All dimensions are in metric(mm). 2) Tolerances are as follows: 1 PL DEC ±0.30 2 PL DEC ±0.15 3 PL DEC ±0.08 Fractions ±1/64 Angles ±1° 3) Note reference =		<table border="1"> <tr> <th>SIGNATURES</th> <th>DATE</th> </tr> <tr> <td>DRAWN: JARRY</td> <td>27DEC13</td> </tr> <tr> <td>CHECKED:</td> <td></td> </tr> <tr> <td>ENGINEER:</td> <td></td> </tr> <tr> <td>APPROVAL:</td> <td></td> </tr> </table>		SIGNATURES	DATE	DRAWN: JARRY	27DEC13	CHECKED:		ENGINEER:		APPROVAL:	
SIGNATURES	DATE												
DRAWN: JARRY	27DEC13												
CHECKED:													
ENGINEER:													
APPROVAL:													
MATERIAL SPECIFICATIONS:		<p style="text-align: center;"><b>Amphenol</b></p> <p style="text-align: center;">Sine Systems - www.amphenol-sine.com 44724 Morley Drive Clinton Township, MI 48036</p> <p style="text-align: center;"><b>PLUG, 8 SOCKET, AT SERIES, KEYED</b></p>											
PROCESS SPECIFICATIONS:													
NEXT ASSY:	<table border="1"> <tr> <td>THIS DRAWING IS SUPPLIED FOR INFORMATION ONLY. DESIGN FEATURES, SPECIFICATIONS AND PERFORMANCE DATA SHOWN HEREON ARE THE PROPERTY OF THE AMPHENOL CORPORATION. NO RIGHTS OF REPRODUCTION ARE IMPLIED. ALL DIMENSIONS ARE SUBJECT TO NORMAL MANUFACTURING VARIATIONS.</td> <td>SIZE: <b>B C-</b></td> <td>TYPE:</td> <td>DWG NO.: <b>AT06-08SX-XXX</b></td> <td>REVISION: <b>A3</b></td> </tr> </table>		THIS DRAWING IS SUPPLIED FOR INFORMATION ONLY. DESIGN FEATURES, SPECIFICATIONS AND PERFORMANCE DATA SHOWN HEREON ARE THE PROPERTY OF THE AMPHENOL CORPORATION. NO RIGHTS OF REPRODUCTION ARE IMPLIED. ALL DIMENSIONS ARE SUBJECT TO NORMAL MANUFACTURING VARIATIONS.	SIZE: <b>B C-</b>	TYPE:	DWG NO.: <b>AT06-08SX-XXX</b>	REVISION: <b>A3</b>						
THIS DRAWING IS SUPPLIED FOR INFORMATION ONLY. DESIGN FEATURES, SPECIFICATIONS AND PERFORMANCE DATA SHOWN HEREON ARE THE PROPERTY OF THE AMPHENOL CORPORATION. NO RIGHTS OF REPRODUCTION ARE IMPLIED. ALL DIMENSIONS ARE SUBJECT TO NORMAL MANUFACTURING VARIATIONS.	SIZE: <b>B C-</b>	TYPE:	DWG NO.: <b>AT06-08SX-XXX</b>	REVISION: <b>A3</b>									
SCALE: NONE		SHEET 1 OF 2											

REVISIONS					
REV	ECO	DESCRIPTION	DATE	BY	APPR

P/N AT06-08SA  
KEY-A CONFIGURATION  
STANDARD COLOR: GREY

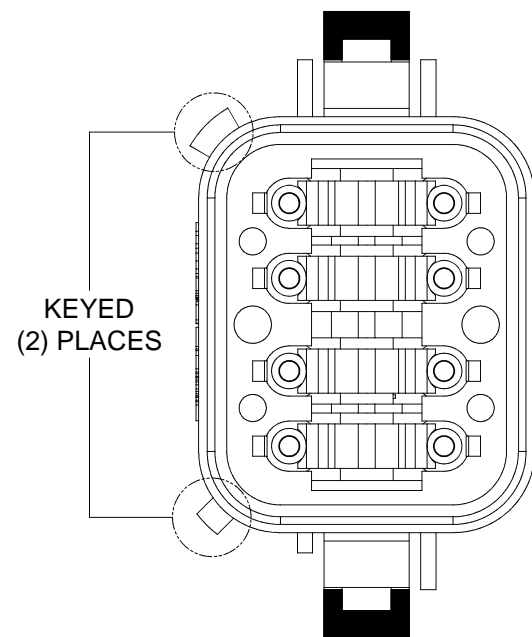

KEY-A CONFIGURATION	
COLOR	PART NUMBER
<b>* GREY</b>	<b>AT06-08SA</b>
BLACK	AT06-08SA-BLK
GREEN	AT06-08SA-GRN
BROWN	AT06-08SA-BRN

P/N AT06-08SB  
KEY-B CONFIGURATION  
STANDARD COLOR: BLACK

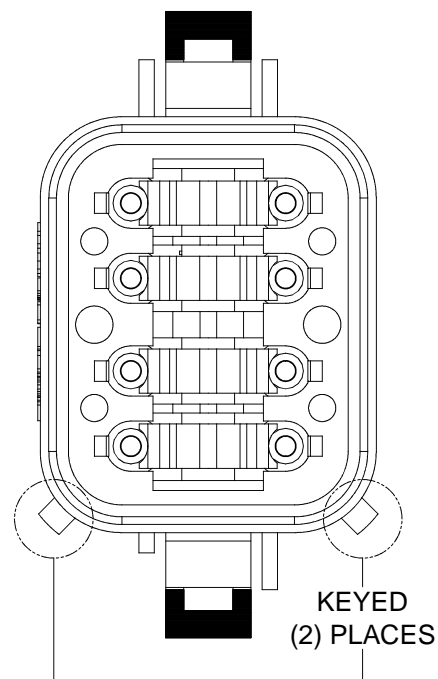

KEY-B CONFIGURATION	
COLOR	PART NUMBER
GREY	AT06-08SB-GRY
<b>* BLACK</b>	<b>AT06-08SB</b>
GREEN	AT06-08SB-GRN
BROWN	AT06-08SB-BRN

P/N AT06-08SC  
KEY-C CONFIGURATION  
STANDARD COLOR: GREEN

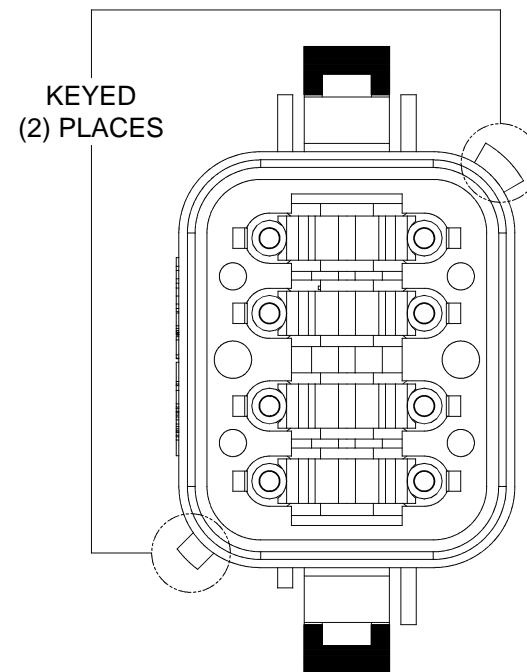

KEY-C CONFIGURATION	
COLOR	PART NUMBER
GREY	AT06-08SC-GRY
BLACK	AT06-08SC-BLK
<b>* GREEN</b>	<b>AT06-08SC</b>
BROWN	AT06-08SC-BRN

P/N AT06-08SD  
KEY-D CONFIGURATION  
STANDARD COLOR: BROWN

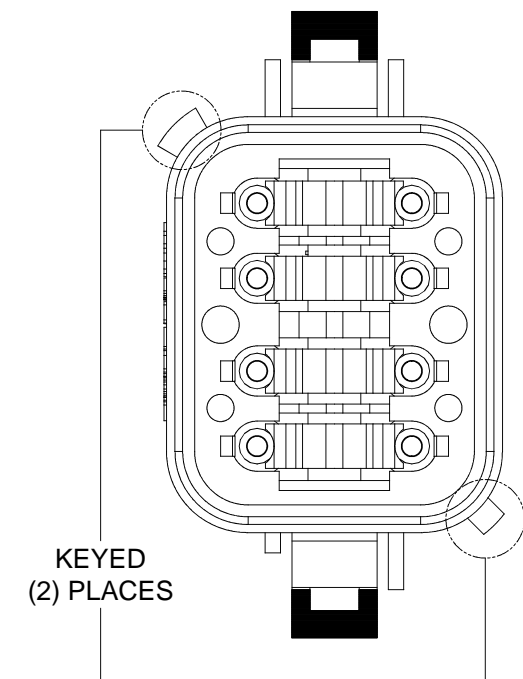

KEY-D CONFIGURATION	
COLOR	PART NUMBER
GREY	AT06-08SD-GRY
BLACK	AT06-08SD-BLK
GREEN	AT06-08SD-GRN
<b>* BROWN</b>	<b>AT06-08SD</b>

NOTE:

AN ASTERISKS ( \* ) PLACED BEFORE THE COLOR DENOTES THE STANDARD MOLDED COLOR OF THE CONNECTORS SHOWN ABOVE.



OTHER COLORS SHOWN ARE AVAILABLE VIA SPECIAL ORDER.



TITLE: PLUG, 8 SOCKET, AT SERIES, KEDED  
DWG NO: AT06-08SX-XXX  
REV: A3  
SH: 2  
OF: 2





QUANTITY	PART NUMBER	DESCRIPTION	ITEM												
<b>MATERIALS LIST</b>															
UNLESS OTHERWISE SPECIFIED 1) All dimensions are in metric(mm). 2) Tolerances are as follows: 1 PL DEC ±0.30 2 PL DEC ±0.15 3 PL DEC ±0.08 Fractions ±1/64 Angles ±1° 3) Note reference =		<table border="1"> <tr> <th>SIGNATURES</th> <th>DATE</th> </tr> <tr> <td>DRAWN: JARRY</td> <td>27DEC13</td> </tr> <tr> <td>CHECKED:</td> <td></td> </tr> <tr> <td>ENGINEER:</td> <td></td> </tr> <tr> <td>APPROVAL:</td> <td></td> </tr> <tr> <td colspan="2">CUSTOMER:</td> </tr> </table>		SIGNATURES	DATE	DRAWN: JARRY	27DEC13	CHECKED:		ENGINEER:		APPROVAL:		CUSTOMER:	
SIGNATURES	DATE														
DRAWN: JARRY	27DEC13														
CHECKED:															
ENGINEER:															
APPROVAL:															
CUSTOMER:															
MATERIAL SPECIFICATIONS:		<h1>Amphenol</h1> <p>Sine Systems - www.amphenol-sine.com 44724 Morley Drive Clinton Township, MI 48036</p> <p><b>PLUG, 8 SOCKET, AT SERIES, KEYED</b></p>													
PROCESS SPECIFICATIONS:															
NEXT ASSY:		<table border="1"> <tr> <td>SIZE: <b>B C-</b></td> <td>DWG NO: <b>AT06-08SX-XXX</b></td> <td>REVISION: <b>A3</b></td> </tr> <tr> <td>SCALE: <b>NONE</b></td> <td colspan="2">SHEET <b>2</b> OF <b>2</b></td> </tr> </table>	SIZE: <b>B C-</b>	DWG NO: <b>AT06-08SX-XXX</b>	REVISION: <b>A3</b>	SCALE: <b>NONE</b>	SHEET <b>2</b> OF <b>2</b>								
SIZE: <b>B C-</b>	DWG NO: <b>AT06-08SX-XXX</b>	REVISION: <b>A3</b>													
SCALE: <b>NONE</b>	SHEET <b>2</b> OF <b>2</b>														

# AT Series™ - Contact Size 16 Options



Machined Contacts, Sockets & Pins				
Part Number	Description	Size	AWG	Type
AT60-215-1631	Male Contact - Pin, Gold-plated	16	14	Machined
AT62-209-1631	Female Contact - Socket, Gold-plated	16	14	Machined
AT60-215-16141	Male Contact - Pin, Nickel-plated	16	14	Machined
AT62-209-16141	Female Contact - Socket, Nickel-plated	16	14	Machined
AT60-202-1631	Male Contact - Pin, Gold-plated	16	16-20	Machined
AT62-201-1631	Female Contact - Socket, Gold-plated	16	16-20	Machined
AT60-202-16141	Male Contact - Pin, Nickel-plated	16	16-20	Machined
AT62-201-16141	Female Contact - Socket, Nickel-plated	16	16-20	Machined
AT60-202-1631-22	Male Contact - Pin, Gold-plated	16	22-24	Machined
AT62-201-1631-22	Female Contact - Socket, Gold-plated	16	22-24	Machined
AT60-202-16141-22	Male Contact - Pin, Nickel-plated	16	22-24	Machined
AT62-201-16141-22	Female Contact - Socket, Nickel-plated	16	22-24	Machined

Tooling - Machined Contacts		
Part	Part Number	Description
	CA-5D12	Universal Hand Crimp Tool, Size 12/16/20 (Machined contacts only)
	CA-5E12	Pneumatic Crimp Tool, Size 12/16/20 (Machined contacts only)

Contact Removal Tools		
Part	Part Number	Description
	ART-100	Used for removal of contacts for A Series™ products
	AT11-310-1605	Contact Removal Tool, Plastic, Size 16

Sealing Plugs		
Part	Part Number	Description
	A114017	Sealing Plug, Size 16, White
	A114017-SR	Sealing Plug, Size 16, SR01 Series, Black
	AT13-217-1605	Locking Sealing Plug, Size 16, Grey
	AT13-217-1605-SR	Locking Sealing Plug, Size 16, SR01 Series, Red

Stamped & Formed Contacts, Sockets & Pins				
Part Number	Description	Size	AWG	Type
AT60-14-0144	Male Contact - Pin, Gold-plated	16	14-16	Stamped & Formed
AT62-14-0144	Female Contact - Socket, Gold-plated	16	14-16	Stamped & Formed
AT60-14-0122	Male Contact - Pin, Nickel-plated	16	14-16	Stamped & Formed
AT62-14-0122	Female Contact - Socket, Nickel-plated	16	14-16	Stamped & Formed
AT60-16-0144	Male Contact - Pin, Gold-plated	16	16-18	Stamped & Formed
AT62-16-0144	Female Contact - Socket, Gold-plated	16	16-18	Stamped & Formed
AT60-16-0122	Male Contact - Pin, Nickel-plated	16	16-18	Stamped & Formed
AT62-16-0122	Female Contact - Socket, Nickel-plated	16	16-18	Stamped & Formed
AT60-16-0644	Male Contact - Pin, Gold-plated	16	18-20	Stamped & Formed
AT62-16-0644	Female Contact - Socket, Gold-plated	16	18-20	Stamped & Formed
AT60-16-0622	Male Contact - Pin, Nickel-plated	16	18-20	Stamped & Formed
AT62-16-0622	Female Contact - Socket, Nickel-plated	16	18-20	Stamped & Formed
AT60-16-0844	Male Contact - Pin, Gold-plated	16	20-22	Stamped & Formed
AT62-16-0844	Female Contact - Socket, Gold-plated	16	20-22	Stamped & Formed
AT60-16-0822	Male Contact - Pin, Nickel-plated	16	20-22	Stamped & Formed
AT62-16-0822	Female Contact - Socket, Nickel-plated	16	20-22	Stamped & Formed

Tooling - Stamped & Formed Contacts		
Part	Part Number	Description
	MF-3950	Crimp Die - Size 16, 18-20AWG (S&F contacts only)
	MF-3953	Crimp Die - Size 16, 16-18AWG (S&F contacts only)
	MF-3975	Crimp Die - Size 16, 14-16AWG (S&F contacts only)
	MF-3990	Crimp Die - Size 16, 20-22AWG (S&F contacts only)
	ATT-16-00	Hand Crimp Tool - Size 16, 14-16AWG (S&F contacts only)
	ATT-16-01	Hand Crimp Tool - Size 16, 18-20AWG (S&F contacts only)
	ATT-1612-03	Hand Crimp Tool - Size 16, 20-22AWG (S&F contacts only)

**Amphenol Sine Systems**  
 44724 Morley Drive  
 Clinton Township, MI 48036 USA  
[www.amphenol-sine.com](http://www.amphenol-sine.com)  
 03/2022